

S. 455.

A
JOURNAL
OF
NATURAL PHILOSOPHY,
CHEMISTRY,
AND
THE ARTS.

*k with previous
(4^o) Series*

VOL. I.

Illustrated with Engravings.

BY WILLIAM NICHOLSON.

LONDON:

PRINTED BY W. STRATFORD, CROWN-COURT, TEMPLE-BAR; FOR
THE AUTHOR, No. 10, SOHO-SQUARE;
AND SOLD BY
G. AND J. ROBINSONS, PATERNOSTER-ROW.

1802.



PREFACE.

THE conclusion of the first Volume of the new Series of this Journal, demands that I should return my sincerest acknowledgments to those excellent Correspondents who have assisted me in improving it, and to the Public at large, who have shewn by the increased demand, that they approve the alterations which have been made.

Among the advantages I will here mention only two; the first by no means inconsiderable, is the very neat and correct typographical execution, which would be honorable to the Printer of a complete copy of a work at leisure, and is singularly valuable in a periodical work;—the other, namely the side notes, requires so much diligence and expence, that it is likely they will long continue to be peculiar to this Journal. These circumstances, added to the unvaried fidelity of conduct in quotation and regard to the rights of others; from which the Editor never has nor will depart, have naturally led men of eminence to chuse this Journal as the repository for their communications.

It is with a very high degree of satisfaction that I can state, that half the materials contained in the present Volume are original, and avowed by their very respectable Authors; that one third part consists of translations, or abstracts of excellent works never before published in English, and that the remaining sixth part are select Memoirs, either abridged or extracted from the Transactions of the Royal Society, and other recent and authentic sources of discovery.

The Authors of original Papers are Doctors Thomson, Beddoes, Higgins, and Priestley; the Rev. W. Pearson; Messrs. Gough, Close, Davy, Murray, R. L. Edgeworth, Stodart, Zach, Accum, Ez. Walker, Goodwyn, W. Walker, and W. N.—Of foreign works, Thenard, Peres, Tromsdorf, Prevost, Dolomieu, Proust, Loysel, Hauy, Volta, Van Marum, Le Blanc, Carradori, Darcet, Parmentier, Vauquelin, Darracq.—And of English Memoirs abridged or extracted, Mendoza, Herschel, Chenevix, Davy, Ware, Cooper,

PREFACE.

Cooper, Englefield, Delafons, Sheldrake, Capper, Arkwright. For the various and important objects of their research, he must refer to the Table of Contents, the ample Index, and the other assistant indications he has been sedulous to present to the Reader.

This Volume contains sixteen Copper Plates, illustrating nineteen distinct objects : viz. Herschel's discoveries of the Structure and Changes of the Sun. 2. Various circular Instruments for measuring Angles, 3, 4. Two Hydraulic Engines invented by Mr. Close for raising water above its Level by the Syphon. 5. Method of making Gun Flints. 6. Mr. Cooper's Designs to shew by the structure of the Ear, that a species of Deafness may be cured by puncture of the Membrane of the Tympanum. 7. Loysel's new Apparatus for bleaching Paper. 8. Carangeau's Instrument for measuring Crystals. 9. Dr. Thomson's Apparatus to shew that the Rumfordian Circulation of Solids in Fluids is not occasioned by Currents. 10. Volta's Sketches in support of his Theory of Galvanism. 11. Trevithack's new and powerful Engine for producing Mechanic Force by an included Column of Water. 12. Mr. Murray's Apparatus for new Experiments on the conducting Power of Fluids. 13. Dr. Herschel's Apparatus for viewing the Sun through Fluids. 14. Mr. Hornblower's Hydraulic Bellows for a Forge. 15. Rev. Wm. Pearson's Projection of the Orbits of the Earth and of the new Planet Ceres, 16. Mr. Murray's Apparatus for shewing the conducting Power of Mercury and of Oil in a Vessel of Ice. 17. A simple and free Escapement for Time Pieces, by Mr. Delafons. 18. Mr. Arkwright's Engine for raising Ores from Mines. And, 19. A cheap, simple, and accurate perspective Instrument, by Richard Lovell Edgeworth, Esq.

With prospects already so animating, under the favorable circumstances of a general Peace, and the facilities it affords to philosophical pursuits and manufacturing inventions, it is to be expected that the value of our communications and discoveries will increase.

Soho Square, London, May 1, 1802.

TABLE OF CONTENTS

TO THIS FIRST VOLUME.

JANUARY 1802.

E NGRAVINGS of the following Objects: 1. Dr. Herschel's Discoveries of the Constitution of the Sun; 2. Circular Instruments by Reflection of Mayer, Borda, and Mendoza; and, 3, 4. Two Hydraulic Engines by Mr. Clofe, in which the Syphon is rendered effective in raising Water above its Level for an unlimited Time.		
I. On the Exhibition of a Series of Primes, and the Resolution of a Compound Number into all its Factors. By Mr. J. Gough.	Page 1	
II. On an improved Reflecting Circle. By Joseph de Mendoza Rios, Esq. F. R. S.	4	
III. Observations tending to investigate the Nature of the Sun, in order to find the Causes or Symptoms of its variable Emission of Light and Heat; with Remarks on the Use that may possibly be drawn from Sellar Observations. By William Herschel, LL. D. F. R. S.	13	
IV. Observations and Experiments upon Dr. James's Powder, with a Method of preparing, in the humid Way, a similar substance. By Richard Chenevix, Esq. F. R. S. M. R. I. A.	22	
V. Construction of an Hydraulic Apparatus, which by Means of the Syphon raises Water above its Level, and performs its Alternations without Attendance. By Mr. Wm. Clofe.	27	
VI. Outline of the Properties and Habitudes of the Metallic Substance, lately discovered by Charles Hatchett, Esq. and by him denominated Columbium.	32	
VII. On the Sebacic Acid, or Acid of Fat. By Cit. Thenard.	34	
VIII. Improvement in the Art of preparing Radical Vinegar. By Cit. Y. Peres, Jun.	39	
IX. An Account of a new Eudiometer. By Mr. H. Davy, Director of the Chemical Laboratory, and Lecturer on Chemistry to the Royal Institution.	41	
X. Analysis of a newly discovered Mineral resembling the Hyacinth. By Professor Tromsdorff.	44	
XI. Philosophical Disquisitions on the Processes of common Life—Art of Shaving—W. N.	47	
XII. Abstract of the Enquiries of Cit. Benedikt-Prevost, and some other Natural Philosophers, relative to the Motions of Odorous Substances placed upon Water. By Cit. Biot.	51	
XIII. Case of a young Gentleman, who recovered his Sight when seven Years of Age, after having been deprived of it by Cataracts, before he was a Year old; with Remarks. By Mr. James Ware, Surgeon.	57	
Scientific News. French National Institute.—New Planet.	69 to 72	
Account of Books of Science. Transactions of the Royal Society.—Gregory's Economy.—Murray's Chemistry.—Copper on Wind and Monsoons.—J. G. W. on Beet Sugar.—Des Mortieres on Prussian Blue.—Socquet on Caloric.—Clanlaire's Atlas of the South of Europe.—Memoirs of the Agricultural Society.	73 to 79	
Books imported.	79, 80	
VOL. I.—1802.	2	FEBRUARY.

FEBRUARY 1802.

Engravings of the following Objects: 1. The Method of making Gun-Flints; 2. Structure of the Human Ear; to illustrate the Cure of a Species of Deafness; 3. The new Apparatus for bleaching the Materials of Paper. And, 4. The Graphometer for measuring Crystals; Dr. Thomson's Apparatus for ascertaining whether Fluids move by change of Temperature; and some Apparatus for shewing the Electricity afforded by Contact of Metals.		
I. On the supposed Currents in hot Liquids. By Thomas Thomson, M. D. Lecturer on Chemistry in Edinburgh. From the Author.		Page 81
II. A Memoir on the Art of making Gun-Flints. By Citizen Dolomieu.		88
III. Letter from Dr. Beddoes on Prognostics of the Weather, the Effects of the Nitrous Oxide, and other Objects.		98
IV. On the Quantity of Nutriment to be obtained from various Kinds of Bones, and the best Method of extracting it, by Professor Proust.		100
V. Observations on the Effects which take Place from the Destruction of the Membrani Tympani of the Ear; with an Account of an Operation for the Removal of a particular Species of Deafness. By Mr. Afley Cooper.		102
VI. Note respecting the Absorption of Nitrous Gas, by Solutions of Green Sulphate and Muriate of Iron. By Mr. H. Davy, Director of the Laboratory, and Lecturer on Chemistry to the Royal Institution.—(From the Author.)		107
VII. On certain Metallic Sulphurets. By Proust, Professor of Chemistry at Madrid		109
VIII. A Memoir on the Method of Bleaching the Paste of Paper. By Cit. Løysel.		118
IX. On the Sound produced by a Current of Hydrogen Gas passing through a Tube. With a Letter from Dr. Higgins, respecting the Time of its Discovery.		129
X. Description of the Graphometer, or Instrument of Cit. Carangeau, for measuring the Angles of Crystals.—From the Mineralogie of Cit. Haüy.		132
XI. Letter of Professor Volta to J. C. Delamethrie, on the Galvanic Phenomena.		135
XII. An Account of a Method of Constructing Simple and Compound Galvanic Combinations, without the Use of Metallic Substances, by Means of Charcoal and different Fluids. By Mr. Davy.		144
XIII. Short Analysis of the Principles and Structure of Mr. Close's Hydraulic Engine—W. N.		145
XIV. Simple Process for taking a Copy of a Recent Manuscript. Communicated to the Philomathic Society at Paris. By Charles Coquebert.		147
XV. Narrative and Explanation of the Appearance of Phantoms, and other Figures in the Exhibition of the Phantasmagoria. With Remarks on the Philosophical Use of Common Occurrences.—W. N.		ib.
Scientific News. Extract of a Letter from Doctor Lorenz De Crell.—Corrindon or Adamantine Spar found near Philadelphia.—Nature of the Earth which is eaten by the Inhabitants of New Caledonia.—Account of a blue Oxide of Iron.—Use of Whiskers in certain Quadrupeds.—Galvanic Charge of a large Battery by the Metallic Pile.		151 to 154
Account of Books of Science. Davy's Syllabus of a Course of Lectures on Chemistry—Kelly's Elements of Book-keeping—Memoir sur l'Influence de l'Air, &c.—Memoirs d'Agriculture, &c.		155 to 159
Books imported		160

MARCH

M A R C H 1802.

Engravings of the following Objects: 1. A new and powerful Engine, which acts by the alternate or double Pressure of a Column of Water on each Side of a Piston. By Mr. R. Trevithack. 2. Dr. Murray's Apparatus for new Experiments on the Transmission of Heat through Fluids. 3. Dr. Herschell's darkening Apparatus to view the Sun through Fluids. And, 4. Hydraulic Bellows for a Smith's Forge. By Mr. Hornblower.		
I.	Description of an Engine which operates by the Pressure and Descent of a Column of Water against a Piston; nearly in the same Manner as the double Steam Engine operates by Means of Steam. Communicated by the Inventor Mr. Richard Trevithack, of Camborne, near Truro, in Cornwall	Page 161
II.	Experiments and Remarks on the Passage of Heat through Fluids downwards, particularly with Regard to the Uncertainty produced by the Vessel; with a Method of obviating that Uncertainty altogether. By John Murray, M. D. Lecturer on Natural Philosophy and Chemistry at Edinburgh. Communicated by the Author	165
III.	Letter from Dr. Van Marum to Mr. Volta, Professor at Pavia, containing Experiments on the Electric Pile, made by him and Professor Pfaff, in the Teylerian Laboratory at Haarlem, in November, 1801	173
IV.	A Reply to Mr. Cruickshank's Observations in Defence of the New System of Chemistry, in the Philosophical Journal. By Joseph Priestley, L. L. D. F. R. S. &c. Communicated by the Author	181
V.	A Statement of the Experiments made by the Rev. Abraham Bennet, F.R.S. on the Electricity produced by the contact of Metals previous to the Year 1789, and also of those made by Mr. Tiberius Cavallo, F. R. S. previous to the Year 1795, to which Allusion was made at Page 144 of this Journal. —W. N.	184
VI.	On the Formation of Crystals, describing a Method of producing them large and regular. By Cit. Le Blanc	191
VII.	Accounts of the New Planet Ceres	193
VIII.	Observations and Experiments relating to the Pile of Volta. In a Letter from Joseph Priestley, L. L. D. F. R. S.	193
IX.	Experiments and Observations towards determining the Influence of Oxygen on Germination. By Dr. Carradori	204
X.	On the Choice and Use of a Razor. By a Correspondent	210
XI.	Observations on the Method of painting with Milk. By Cit. Darcet, Member of the Lyceum of Arts, and Essayer of Money	212
XII.	Description of an Hydraulic Bellows for a Smith's Forge. By Mr. J. C. Hornblower	219
XIII.	On the Practicability and Advantage of a general System of Rail-Roads, and the Means of carrying the same into Effect. In a Letter from Richard Lovell Edgeworth, Esq.	212
XIV.	Description of the darkening Apparatus for Telescopes by Means of Fluids. By William Herschel, L. L. D. F. R. S.	217
XV.	On the Effects of the Respiration of the Nitrous Oxide; particularly an Instance in which the Excitation of the System produced unpleasant Symptoms. In a Letter from Mr. James Stodart	225
XVI.	Remarks on the Processes for clarifying Liquids. By Cit. Parmentier	228
Scientific News. Extract of a Letter from Brunn, in Moravia—On the Muria-tic Aid—A new Method of obtaining the Gallic Acid pure—Extracts of a Letter of Cit. Vauquelin to Cit. Van Mons		234 to 233
Account of Books of Science. Murray's Elements of Chemistry—Young's Syllabus of a Course of Lectures on Natural and Experimental Philosophy—Mr. Blair's Popular Lectures		239, 249

APRIL 1802.

- Engravings of the following Objects: 1. The Rev. Mr. Pearson's Projection of the Orbits of the Earth, and the new Planet Ceres. 2. Apparatus by which Mr. Murray has shewn that Fluids conduct Heat downwards, when the Vessel is effectivly a Nonconductor. 3. Mr. De Lafons's free Escapement for Time Pieces. 4. Mr. Arkwright's Engine for raising Ores from Mines. And, 5. A cheap, simple, and accurate perspective Instrument, by R. L. Edgeworth, Esq.
- I. Experiments on the Transmission of Heat downwards through Mercury and through Oil contained in Vessels of Ice; by which those Fluids are proved to be proper Conductors of Heat. By John Murray, Lecturer in Chemistry, Materia Medica, and Pharmacy, at Edinburgh. Communicated by the Author. - - - - - Page 241
- II. Description of a new Escapement for Watches, invented by Mr. John De Lafons. - - - - - 251
- III. Remarks on the Processes for clarifying Liquids. By Citizen Parmentier. - - - - - 253
- IV. On the Discovery of the Arseniates of Copper and of Iron. By a Correspondent. - - - - - 258
- V. On the Nature and Preparation of drying Oils; with a View to the Improvement of such as are used by Artists, as Vehicles for Painting. By Mr. Timothy Sheldrake. - - - - - 259
- VI. On the Native and Artificial Sulphurets of Iron. By Professor Proust. 269
- VII. General Observations on the Causes which influence the Weather in England, and the popular Methods of judging of the Weather. By James Capper, Esq. formerly Colonel and Comptroller General of the Army and Fortification Accounts on the Coast of Coromandel. - - - - - 275
- VIII. Description of a cheap, simple, and portable Instrument, for determining the Positions of Objects in taking a Picture from the Life. By R. L. Edgeworth, Esq. - - - - - 281
- IX. Concerning the new Planet Ceres. In a Letter from the Rev. William Pearson, including an Extract of a Letter from the Baron De Zach to Mr. Edward Troughton. - - - - - 284
- X. Entertaining chemical Experiments; with Notices of various new Facts and Observations respecting the Products of Nature and Art. By Mr. Frederick Accum. Communicated by the Author. - - - - - 295
- XI. The Method of crystallizing Lime. By Tromsdorff. - - - - - 302
- XII. On the Crystallization of the Hydrosulphuret of Soda. By Cit. Vauquelin. - - - - - 303
- XIII. Memoir respecting a new Combination discovered in Zaffre, which Cit. Brugnatelli supposed to be a peculiar Acid, which he denominated the Cobaltic Acid. By Cit. Darracq. - - - - - 304
- XIV. On the Plumb Line and Spirit Level. By Ezekiel Walker. Communicated by the Author. - - - - - 309
- XV. Description of a Machine for raising Ore from Mines. By Mr. T. Arkwright, of Kendal, Westmoreland. - - - - - 313
- XVI. Curious Properties of Prime Numbers, taken as the Divisors of Unity. By a Correspondent. - - - - - 314
- Scientific News. Extract of a Letter from Mr. W. Walker, Lecturer in the Eidouranian, on the new Planet Ceres.—Extract of a Letter from M. Zach, Director of the Observatory of Gotha, to C. Mechain, of the Institute, Administrator of the Observatory at Paris.—Spiders' Webs to form the cross Wires in the Eye Piece of Astronomical and other Instruments.—Thick Iron burned in Oxygen.—Extreme Accuracy of tuning Musical Instruments. - - - - - 317 to 320

ERRATA.

I have observed no Errata by which the Reader can be misled, but must remark, that the table at page 73, called *Observations* of the Ceres is wrong intitled: the table being merely an ephemeris, *calculated* for re-discovering the planet from the former observations of Piazzi.

A
JOURNAL
OF
NATURAL PHILOSOPHY, CHEMISTRY,
AND
THE ARTS.

JANUARY, 1802.

ARTICLE I.

On the Exhibition of a Series of Primes, and the Resolution of a Compound Number into all its Factors. By Mr. J. GOUGH.

To Mr. NICHOLSON.

SIR,

M. EULER remarks in his Algebra, that mathematicians have not yet discovered a way of exhibiting a natural series of primes; and in reality I know of no writer on arithmetic, who shews how a compound number may be resolved into all its factors, otherwise than by trial. The following method, however, may be said to solve both problems, perhaps in as ready a way as the nature of numbers will admit; and on fixed principles: it depends upon the following property of compound numbers.

Natural series of primes and resolution of a number into its factors not yet effected.

If a compound number, which is not a square, be resolved into any two of its factors, one of these factors will be less than the root of the next greater square, and the other will be equal to, or greater than the same root.—If you deny the property, then both factors must be either greater than the root of the square, in which case the product will be greater than the square; or, they must be both less, than that root, on which

Property of compound numbers.

supposition the product will not be greater than the next less square, seeing the factors are whole numbers. Now suppose $f^2 - c$ to represent any number whatever, where f^2 is the next greater square, and c the excess of that square above the given number: then any two factors of $f^2 - c$ may be expressed by $f - p$, and $f + p + 2n$, from whence the following method of determining all the factors to two successive squares, and their intermediate numbers, is easily derived.

Method of determining factors.

In a perpendicular column at the left hand of your future work, (*vide Tab. 1st.*) which exhibits the divisors of all the numbers from 49 to 36, write down the arithmetic progression 1, 2, 3, &c. beginning at the top with unity, and ending with f ; let all these numbers successively represent the divisor $f - p$, and corresponding to each of them, draw a double horizontal column: when $f - p = 1$, make c in the uppermost horizontal column $= 2f - 1, 3f - 2, 2f - 3, \&c.$ to 0, because $2f - 1$ is the difference of the two squares in all cases; and for $f + p + 2n$, write $f - 1^2, \overline{f - 1}^2 + 1, \overline{f - 1}^2 + 2, \&c.$ to f^2 . In order to fill up the other columns, divide f^2 by the respective value of $f - p$, and place the remainder, if there be any, in the upper part of the horizontal column, perpendicularly under the same value of c in the highest column; but if there be no remainder, place a cypher in its room: then increase this remainder as often as you can by the addition of $f - p$, not to make it exceed $2f - 1$, and place these, each directly under the same number in the highest column, and write c on the left hand.

Under the first remainder or cypher, place the quotient $\frac{f^2}{f - p}$ in whole numbers; from which, subtract unity as oft as $f - p$ was added to the remainder, and call these $f + p + 2n$; but when $f - p = f$, put 0 alone for the value of c : when all the columns are filled up in this manner, the factors of any given number are thus found. Find the value of c corresponding to that number in the highest column; then find how often the same number recurs, by casting your eye perpendicularly down the columns, the factors will be the value of $f + p + 2n$, directly under that value of c in each column; and the corresponding value of $f - p$: consequently, these values of c which are only found in the highest column, indicate that the
number

number directly under it is a prime, as is the case in *Tab. 1st*; with 37, 41, 43, 47.

But if a series of primes only is to be calculated, the work may be shortened, by omitting the values of $f + p + 2n$ in all the columns except the highest, and marking those numbers with asterisks which correspond to the values of c only found in the uppermost line, as in *Tab. 2d.* where the prime numbers from 1 to 16 are calculated.

Note, the values of c may be otherwise calculated:—from the product fp take the greatest multiple of $f - p$ that can be subtracted from it; this will give the least value of c corresponding to that value of $f - p$.

Your's, &c.

Kendal, Dec. 7, 1801.

J. GOUGH.

TABLE I.

$f^2 = 49$

$f - p = 1$	$c =$	13	12	11	10	9	8	7	6	5	4	3	2	1	0
	$f + p + 2n =$	36	37	38	39	40	41	42	43	44	45	46	47	48	49
$f - p = 2$	$c =$	13		11		9		7		5		3		1	
	$f + p + 2n$	18		19		20		21		22		23		24	
$f - p = 3$	$c =$	13			10			7			4			1	
	$f + p + 2n$	12			13			14			15			16	
$f - p = 4$	$c =$	13				9				5				1	
	$f + p + 2n$	9				10				11				12	
$f - p = 5$	$c =$					9					4				
	$f + p + 2n$					8					9				
$f - p = 6$	$c =$	13						7						1	
	$f + p + 2n$	6						7						8	
$f - p = f$	$c =$														0
	$f + p + 2n$														7

TABLE II.

From 1 to 4				From 5 to 9					From 10 to 16								
$f-p=1$	$c=$	3	2	1	0	4	3	2	1	0	6	5	4	3	2	1	0
		*	*	*		*		*				*		*			
	$f+p+2n$	1	2	3	4	5	6	7	8	9	10	11	12	13	14	15	16
$f-p=2$	$c=$				0		3		1		6		4		2		0
$f-p=3$	$c=$									0			4			1	
$f-p=4$	$c=$																0

II.

On an improved Reflecting Circle. By JOSEPH DE MENDOZA RIOS, Esq. F. R. S. (*Phil. Transf.* 1801.)

Advantages of large instruments in diminishing the errors of division and eccentricity.

IN practical astronomy large instruments are useful, not only to enable the observer to read the angles to a small fraction of a degree, but likewise to diminish, in the construction, the inaccuracies which proceed both from the errors of the divisions and the eccentricity of the index. Frames of considerable dimensions admit also the application of telescopes with great magnifying powers, which is a circumstance of the utmost importance in celestial observations. As the reflecting instruments employed at sea are supported by the hand, their weight and scale are limited within a narrow compass; and it seemed very difficult to obviate, by any expedient, the inconveniences arising from the smallness of their size, while it was impossible to increase it. The celebrated Tobias Mayer contrived, however, a method to determine, at one reading, instead of the simple angle observed, a multiple of the same angle; and, by this means, the instrument became, in practice, capable of any degree of accuracy, as far as regards the above mentioned errors. His invention is essentially different from the mere repetition of the observations; and my object requires that I should explain the principle upon which it is founded.

Invention of Mayer for diminishing the same errors at pleasure in small instruments by reflection.

Mr.

Mr. Mayer proposed to complete the limb of the sextant, making a whole circle, with the horizon glass moveable round the centre, with an additional index, which I shall call *the horizon index*, in order to distinguish it from *the centre index*, to which the centre glass is attached. This instrument is represented in Plate I. Fig. 1; and the manner of using it is as follows: after the index A is set at 0, (the beginning of the divisions,) the two glasses are rendered parallel, as is usually practised with Hadley's quadrant, by moving the horizon index B, till the horizon of the sea, (or the sun, or any other object,) or its direct image, and the doubly reflected image of the same, seen through the telescope, coincide.

After fixing the horizon index in that position, the centre index A is to be moved, in order to measure the distance of the two objects S and L, (which I shall suppose the sun and moon,) by bringing into contact the doubly reflected image of the sun with the direct image of the moon, seen through the telescope. The centre image will then be at M, and the arch o M might give, as in the sextant, the angular distance required; but the construction of the circle renders it easy, in this position, to effect again the parallelism of the glasses, and to make another observation of the contact, in the like manner as from o; which operation will bring the centre index to N. The index will then give o N, or double the distance; and, as it must be divided by 2, in order to have the angle required, the errors of division and eccentricity, which, together, I shall call *the error of the instrument*, will be likewise reduced to one half. It is obvious, that by successive repetitions of the same process, triple, quadruple, &c. the distance may be obtained, and the said error further reduced, in the inverse ratio of the multiplication of the distance, to any degree of approximation required.

The method of rendering the glasses parallel, by means of the horizon of the sea, is not accurate, on account of the indistinctness of the images; and, when the sun is used for that purpose, the observation becomes fatiguing to the eye. The repetition of that observation, by one or the other method, remained therefore a considerable inconvenience attached to Mr. Mayer's circle. The author himself seems to have been of that opinion, as he proposed to provide the instrument with a diagonal rule, fixed upon one of the indexes, so that the

1. He made the limb an entire circle. And 2. he fixed the horizon glass upon an index moveable on the same centre, but independent of that which carries the glass called the index glass.

Use. Adjust the glasses parallel by the horizon index.

Observe the angle by the first index and fix it.

Make the glasses again parallel by the horizon index.

Observe the angle as before.

Adjust for parallelism, and repeat the observation.

And as this process may be continued at pleasure, and the first index will pass over the measure of the angle as many times as there are repetitions; Divide the whole space by the number of repetitions, and the quotient will be the correct angle; the errors of the instrument being diminished in the same ratio.

other same ratio.

Objection. It is inconvenient to make the adjustments for parallelism. Happy invention of Borda for removing it.

other index should touch it when the glasses were parallel; but an adjustment of this nature must be subject to great errors, and was never adopted in practice. The Chevalier de Borda, wishing to remove that imperfection, had the happy idea of rendering the parallelism of the glasses unnecessary, by substituting the observation of the angular distance of the two objects, to that of the coincidence of the images of the same object. This constitutes the second great improvement of the reflecting circle, which it is necessary for me to explain, before I proceed to the account of my own investigations*.

By a slight alteration in the construction he renders it practicable to observe the same angle twice, by moving the index in contrary directions without shifting the face of the instrument;

In Borda's circle, the telescope is fixed at some distance from the centre, and the horizon glass is carried near the border of the instrument, as in Plate I. Fig. 2. By this arrangement, the rays of light can arrive at the centre glass, both from the heavenly bodies situated to the right of the horizon index, as S' , and from those situated to the left, as S . Thus, if the glasses are parallel to one another, when the centre index is at o , it is obvious that there are two ways of making the observations. While the direct image of the moon L is seen through the telescope, the angular distance to the sun, if at S , may be measured by moving the centre index to m , in order to produce the contact; or, if the sun is at S' , the same operation may be performed, by using the contrary motion to m' . The first kind of observation, the Chevalier de Borda calls *observation to the left*; and the second, *observation to the right*. Suppose now, that (the horizon index being fixed in the same position) the distance from L to S is observed to the left, by bringing into contact the doubly reflected image of S with the image of L , seen without reflection; let us then turn the instrument round, keeping it in the same plane, so as to have the direct image of S through the telescope, and thus make an observation of the same distance to the right; the position of the centre index being in the first observation at m , and in the second observation at m' , it is clear, that if o is the point where the parallelism of the glasses takes place, om is equal to om' ; and, that the arch mm' , determined by the two positions, will give double the distance.

which gives the double distance, and requires not any adjustment for parallelism.

* It does not belong to my present plan, to explain the effect of Borda's improvement in correcting the errors which arise from the want of parallelism in the surfaces of the glasses. This will be fully considered in another Paper, where I intend to give an account of several investigations which I have made upon that particular subject.

It will be more convenient to have the centre index at o , Convenient ma-
nipulation. when the first observation is made, in order to take the double distance at one reading, after the second observation. For this purpose, the first part of the process may be inverted, by previously fixing the centre index at the beginning of the divisions, and moving the horizon index H towards o , instead of moving the centre index A to m , or towards H .

The last kind of observation, in which the incident ray, This is denomi-
nated the *crossed*
observation. which produces the first image upon the centre glass, may be conceived to run double the angular distance, passing in its way over the line of collimation, has been called, by the Chevalier de Borda, *the crossed observation*.

The same process may be repeated, by fixing alternately It may be re-
peated at plea-
sure. one of the indexes, and moving the other, and continuing successive sets of observations; each set of two crossed observations, one to the right and another to the left. The angle given by the instrument, will be equal to double the angular distance multiplied by the number of sets observed, or, in other terms, to the angular distance multiplied by the number of observations, which are always supposed to be made by pairs; an odd observation being of no value in this manner of using the circle.

I have expressed myself as if the observations could always And will not re-
quire a direct
view of the
brighter object,
if the plane of
the instrument
be reversed at
the second ob-
servation. be made by looking alternately at each object through the telescope, in order to bring into contact the doubly reflected image of the other object. This is not the case in the observations of the distances from the moon to the sun, or a star; it being then indispensable to compare, by reflection, the brightest of the two heavenly bodies; but there is a very easy method of obviating that inconvenience. After the contact of the images of S and L is observed, with the telescope directed to L , the position of the plane of the instrument may be inverted, turning it round the axis of vision OBL ; the incident ray will then answer to the point S' , equally distant from L as S , and the crossed observations will still give SS' , or double the distance.

Whether a circle is used simply, as Mayer proposed it, or according to Borda's method, its peculiar advantages chiefly depend on the multiplication of the distance required. I have therefore turned my attention to the improvement of this principle; and, with that view, I have contrived the construction which I am going to describe.

The author's improvement consists in applying an entire moveable circle, called the flying nonius, within or upon the divided circle. Each of these circles may be attached to either the center index or horizon index by the pressure of a clamp.

In the crossed observations made with Borda's circle, the indexes move alternately through an arch which in the divisions, is equal to double the distance: for example, the centre index comes, in the first crossed observation, from m to m' ; in the third crossed observation, from m' to m'' , &c. and the horizon index, in the second crossed observation, to h' : in the fourth crossed observation, to h'' , &c. and, by each of the two indexes may be found the same multiple of the distance required. Let us now place the Nonius in a circle moving round the centre, over, or adjacent to, the usual limb which contains the divisions: it will easily be conceived, that, by attaching that circle, which I shall call the *Flying Nonius*, alternately to each of the indexes, it will serve as Nonius for both; and that, after any number of observations, it will give the compound motion of the two indexes. Thus, after the first observation, the Flying Nonius will, at each crossed observation, advance double the distance over the divisions, while each separate Nonius, fixed on the indexes, requires a set of two observations, to produce the same effect in Borda's circle.

View and description of the improved reflecting circle,

Plate I. (XXX. XXXI. and XXXII.) exhibits a perspective view, (a plan, and a section,) of the instrument, which, for the sake of distinction, I shall call my *Improved Reflecting Circle*. (The last Plate is particularly intended to shew the compound handle, which I have adapted to the instrument, in order to hold it with convenience and ease in every position *). These three

* The use of Mayer's circle, or of Borda's, as constructed till now, with only one handle attached to the centre, is extremely inconvenient in several positions, and particularly when it must be kept inverted downwards during the observation. For this reason, I thought it of importance to contrive such a support as would enable the observer to hold the instrument with the same ease in every direction. This is effected by means of the compound handle, attached to the horizon index, by the brace V and screw X, (Plates XXX. XXXI. and XXXII.) which index turns round the centre with the handle. When Mr. Troughton began to construct this sort of instrument, I recommended to him this improvement, which he has adapted to his reflecting circle.

I shall observe here, that Mr. Troughton's circles are not of the kind which I have endeavoured to improve. The scheme of his construction may be said to consist in completing the limb of a sextant

tant

three representations, in which the same parts are marked with the same letters, are sufficient to give an accurate idea of the arrangement of the whole, and make it unnecessary for me to enter now into a minute detail of the mechanism of the apparatus. I therefore shall content myself with adding here only what concerns the general use, and the peculiar properties, of this instrument.

M is the divided limb of the circle, and N the Flying Nonius, to each of which the horizon index may be occasionally attached, by means of the clamps D, C; as well as the centre index, by means of the other clamps A, B. The peculiar property of the instrument being that of giving double the distance, I have thought proper to divide the circle into 360 degrees, and not into 720 according to the nature of the sextant. Thus, after a crossed observation, the reading of the Nonius will, without reduction, exhibit the measure of the simple distance. I have likewise extended the nonius round the circumference, so that, by the coincidence of two divisions, the number of degrees will appear on the limb, and that of the minutes and seconds on the flying nonius. The manner of making the observations with this instrument is as follows:

Adapt the 0 of the flying nonius to 360° of the limb; and then fasten the two clamps A, B, of the centre index * E E, by which the divisions will be kept in the same relative situations. Then, turn round the horizon index FF, and make an observation of the distance to the right. The contact must be adjusted by the screw G, the clamp C being fastened.

tant to the whole circumference, and making it capable thereby of performing Borda's crossed observations, with as many noniuses as may be attached to the centre glass. But, Mr. Troughton's instrument is deprived of the principle invented by Mayer, for obtaining at one reading a multiple of the distance required; which is the great property of circles, and, in my opinion, the best means of diminishing their errors.

* Properly speaking, neither the centre nor the horizon indexes act, in this instrument, as such, both of them being deprived of the nonius, which is transferred to the flying circle; but, for the sake of perspicuity, I continue the use of those expressions, in order to distinguish the plates or rules which carry the centre and the horizon glasses.

The circle is divided into whole degrees, and the flying nonius has its divisions extended all round its circle.

Method of observing. Clamp the center index both to the limb and nonius (set with 0 opposite 360°). Observe an angle to the right by moving the horizon index; which then clamp to the nonius. Disengage the center index from the nonius, and repeat the observation to the left; the flying nonius will give the distance.

Leave this clamp fastened, and loosen the clamp A; thus turn the instrument, and make a crossed observation to the left, adjusting by means of the screw H, after having fastened the clamp D. At the end of this observation, the flying nonius will give the distance. Fasten now the clamp A, and loosen the clamps B and C, leaving the clamp D fastened; then turn the instrument again, and make a crossed observation to the right. At the end of this observation, the flying nonius will give double the distance. By successively inverting the use of the clamps, this alternate process may be continued *ad libitum*; and each crossed observation will increase the reading, by an arch equal to the distance.

Remarks.

Let the number of observations be n , and the angular distance D. The arch given by my improved circle will be $= D (n - 1)$. In Borda's circle, (reducing the divisions of the sextant to those of the theodolite I use,) the arch is $= D \times \frac{1}{2} n$; and, either n must be an even number, or the odd observation must be lost. In Mayer's circle, the arch is $= \frac{1}{2} D \times \frac{1}{2} n$; and the number n , which comprehends the observations for the parallelism of the glasses and those for the distance, must likewise be even. The comparison of these expressions, shews at once the relative advantages of the different instruments.

My construction offers considerable advantages, in every manner of using the circle. If, instead of the crossed observations, it should be wanted to employ the usual practice of rendering the glasses parallel, a multiple of the distance may still be obtained by my instrument, equal to that of the other method. For this purpose, the parallelism of the glasses may be effected, by means of the images of the sun, or the horizon of the sea, moving the index F, while the 0 of the nonius is adapted to 360° of the limb, and the two clamps A, B, are fastened. After this, an observation of the distance to the right may be made, with the clamp A fastened, while the clamp B is loose; the clamp D being also fastened, and the clamp C loose; and, at the end of this observation, the flying nonius will give an angle, which will be only the half of the distance in my divisions, but which would be equal to the whole distance, if the divisions were according to the sextant. After that, and while the clamps B and C are fastened, and the clamps A and D loose, the parallelism of the glasses may be

be again effected; and the nonius will advance the same quantity over the limb. The same addition will take place, by inverting the use of the clamps, and making another observation of the distance. The like alternate process may be continued indefinitely; and the result given by the instrument will, with only one observation more, be the same as that of Borda's method, and double the arch which would be obtained by Mayer's circle.

Mr. Borda's circle is liable to a very great inconvenience in practice. Each index advances successively over the limb; and, in order to facilitate the operation of bringing the images for the contact within the telescope, that author advises to make a preparatory memorandum of the positions which the indexes will nearly occupy, so that they may be set accordingly, previous to each observation. But this method, which is always inconvenient, by night becomes almost impossible. For this reason, I have joined to the horizon index an arch LL, (Plates XXX. and XXXI.) which is divided, both to the right and left, into degrees and minutes of the sextant, so that, when the glasses are parallel, the centre index coincides with the two first divisions o, o, and occupies the space left blank between them. I have further provided two sliding pieces P, P, which may be adapted to that arch, with a spring sufficient to keep them firm in any situation. Putting each of these pieces upon the arch, so that their ends may coincide with the divisions marking the rough distance to be measured, no more will be required, than to set the centre index alternately against each piece, before the beginning of the successive crossed observation. The clamp may then be fastened, and the remainder of the motion produced by the adjusting screw; as, if necessary, the index will push the sliding piece further, and leave it at the point where the contact was effected*.

Easy contrivance for setting to the distance nearly, before each observation.

The flying circle facilitates the use of any number of noniuses, which may be applied round the whole circumference; but, as the leading principle which I have chiefly had in contemplation, is that of obtaining an accurate result from one reading, I have only used a single nonius. Two noniuses,

Other advantages, such as the increased number of noniuses, if required.

* The idea of this simple contrivance, was suggested to me by the ingenious Mr. E. Troughton.

opposite one another, might however be advantageous, in order to correct the errors of eccentricity; but, in my opinion, a greater number ought not, in any case, to be used.

It may be used in circles where the telescope is attached.

Before I conclude this Paper, I shall remark, that my improvement may be partially applied to a circle, where the telescope and the horizon glass are attached, or fixed, to the main frame of the instrument. The flying nonius, acting then with the single centre index, will only give the same result as Borda's circle; but this construction seems to me greatly preferable to all the other plans executed till now; the whole apparatus being more solid and simple, and its use not liable to the errors which arise from the motion of the horizon index.

It affords a method of repeating observations beginning from a stop.

With this construction, we may likewise employ a method of ascertaining the place where the parallelism of the glasses was observed to take place, and of setting the index afterwards in the same situation, as often as is necessary for the repetition of the observations. A piece may be used, so contrived as to be attached to, or detached from, one side of the index, by means of a screw; and provided besides with other screws, to fasten it to any part of the limb. This rectification piece, being previously attached to, and carried with, the index, must be fixed in the situation it occupied when the contact of the images was observed. The index will then be detached from it, in order to observe the distance, and afterwards must be brought back to the same position as before, contiguous to the rectification piece. The like alternate process may be repeated; and the flying nonius, going with the index in the motions forwards, and standing still in the motions backwards, will give the multiple of the observed angle, without performing the observation for the parallelism more than once in the beginning. In Mayer's circle, as well as in Borda's, there is a great objection to any attempt for that purpose; because, as the horizon glass moves round with the index, its perpendicular position is deranged by the inequalities of the plane of the limb; but, in my construction for multiplying with the horizon glass fixed, that inconvenience is removed; and the method of ascertaining the identical position of the glasses may be employed in practice, with advantage, it being done when the index is at the same point of the frame. By suggesting this idea, I do not, however, mean to represent it

it as preferable to the repetition of the observations; which process must, for many reasons, have the advantage over any mechanical contrivance whatsoever.

I have procured reflecting circles to be constructed, upon the principles here described, both with the telescope and the horizon glass upon a moveable index, and with the same pieces attached to the main frame of the instrument. The two methods have respectively answered my expectation; and I purpose, at a future opportunity, to publish a description of the means which I wish to recommend for the mechanical improvement of the different parts, together with an account of some other essays which I have made relative to the same subject.

The invention succeeds in practice.

III.

*Observations tending to investigate the Nature of the Sun, in order to find the Causes or Symptoms of its variable Emission of Light and Heat; with Remarks on the Use that may possibly be drawn from Solar Observations. By WILLIAM HERSCHEL, LL. D. F. R. S.**

ON a former occasion this eminent astronomer gave his reasons for inferring that the sun is a most magnificent habitable globe. In the present paper he proceeds considerably farther in the investigation of the physical and planetary construction of that luminary. He introduces his subject by remarking, that the influence of this luminous body on the globe we inhabit is so great and so widely diffused, that it becomes almost a duty for us to study the operations which are carried on at its surface; that from motives arising from the important effects of light and heat we ought certainly to examine their source, and though, like the Egyptians with the Nilometer, or modern philosophers in their observations upon the atmospheric phenomena, we can entertain no hope of modifying the effective causes, yet, by arranging the particulars of our own conduct by the fore-knowledge of events though inevitable, we may add much to the general felicity and enjoyments of society.

The sun inferred to be an habitable globe.

Its influence of the greatest importance to us,

and deserves to be studied.

* Abridged from the Philosophical Transactions, 1801, p. 265.

W. N.

Dr.

New terms of solar phenomena.

Dr. Herschel, in consequence of the improvements in his telescopes, and the advances in his knowledge of the physical construction of the sun, has rejected the old terms of spots, *nuclei*, *penumbrae* & *luculi*, and has substituted those of openings, shallows, ridges, nodules, corrugations, indentations, and pores.

The luminous matter of the sun is of the nature of clouds, or atmospheric phenomena.

In his former paper on the nature and construction of the sun and fixed stars, the author shewed that the lucid substance of the sun is not a liquid nor an elastic fluid, but that it exists in the manner of luminous clouds swimming in the transparent atmosphere of the sun, or rather of lucid decompositions taking place within that atmosphere. * His present observations confirm and extend that induction. They are arranged under certain enunciations, which I shall proceed to give, with so much of the particular facts as may be requisite for their elucidation.

Of Openings.

Openings; or places where the luminous solar clouds are removed.

Openings are places where the luminous clouds of the sun are removed, so as to exhibit the opaque globe of the sun through the aperture. On the 4th of January, 1801, there was a large opening much past the centre of the sun, with a shallow about it, as exhibited in Fig. 1, Plate II. On the preceding side the thickness of the shallow was visible from its surface downwards, but on the following side the edge of the shallow only could be seen, but not its thickness. The side of the elevation surrounding the shallow was also seen going curvedly down to the surface of the shallow on its preceding side. Fig. 2 represents a section of the same opening, in which the lines *a b c d f* are supposed to be drawn from the eye of the observer, corresponding with lines marked by the same letters in Fig. 1. The line *d* goes through the opening to the surface of the sun *A B*. Fig. 2 shews evidently why the thickness of the shallow and elevation of the luminous parts are seen on one side and not on the other.

Particular description.

General facts respecting the solar openings.

Large openings have generally shallows about them. Many openings are without shallows. Small openings are generally without shallows. Openings have generally ridges and nodules about them. The openings have a tendency to run into each

* *Philos. Trans.* 1795, p. 72.

other,

other, and new ones break out near those already formed.

The probable cause of openings is, that an elastic, but not luminous gas, issues up through the pores or incipient openings, and spreads itself on the luminous clouds, forcing them out of the way, and widening its passage. The direction and operation of this cause appears to be not equally extended on all sides, but is frequently oblique, so that the luminous clouds are driven, and form a larger shallow on one side. Different openings being effected similarly, seem to shew a correspondent effect or unity of direction to some extent.

They are produced by a wind or gas from the sun's body.

Fig. 3 represents an opening, with a branch coming from its shallow, seen February 18, 1801. Fig. 4 represents the same opening as it appeared one hour afterwards, broken out at three places on the one side, with corresponding projections in its shallow, which is very large on the side towards which those breakings out point, but is more confined on the other quiescent side.

Changes in the openings observed.

Fig. 5 represents a small oblong opening, with a very long shallow, the luminous matter being close to the opening on the other sides. Eight other small openings, forming a cluster, had each their shallows on the same side. In three hours it changed to the appearance at Fig. 6, and an hour afterwards an opening began to appear in the furthest end of the shadow, as at Fig. 7. When the shallows begin to diminish, and the lips or projections to disappear, the openings were observed to be at the period of their greatest extent. Fig. 8. There is some difference in the colour of openings, apparently from a thin veil of luminous clouds hovering above them. When the openings are decaying, they divide as in Fig. 9, in which observation, December 27, 1799, the luminous passage across the opening resembles a bridge thrown over a cave or hollow space. The opening was completely gone the following day. Openings sometimes increase after beginning to diminish. They generally grow less and vanish. They sometimes become converted into large indentations, with or without pores or small openings, and when they have vanished, they leave the surface disturbed more than common.

Observations.

The depth of the openings is visibly apparent, and the distance between the shallows and the solar surface is indicated by the free motion of low clouds. Fig. 10 shows a large

Observation of the depth, &c. of openings: Low moving clouds.

Narrative. large opening observed January 25, 1801, at 9^h 22^m. The note is as follows: "A large opening, which I have been observing since the 19th, is now much advanced towards the limb. I can see into it; and on the preceding side, as it appears to me, a good way under the lowest regions of the clouds of which the shallow consists. The upper margin of the shallow is very sharply determined; but the clouds at the lower part of it, on the contrary, are more dispersed; some of them hanging a good way down towards the surface of the sun's body. See Fig. 11. At 10^h 20^m the preceding side of the shallow of the large opening is now more abruptly terminated at the bottom of its thickness; the hanging or projecting clouds being removed towards the following side. See Fig. 12."

Of Shallows.

Shallows, or places depressed below the luminous clouds.

Shallows are depressed below the general surface of the sun, and are places where the luminous solar clouds of the upper regions are removed. Their thickness is visible. They sometimes exist without openings in them. They begin from the openings or branch out from shallows already formed, and go forwards. The probable cause of shallows is deduced from the observations, among which the following are delineated.

Observations of the shallows;

January 25, 1801, 9^h 20^m. Two branches, A B, Fig. 13, of a shallow coming from an opening C, going towards the south. It seems as if they were destined to meet the incipient shallow of a south-following opening D. 9^h 50^m the shallow B is very nearly united to the narrow part of the shallow surrounding the opening D. The shallow H seems to advance in a direction towards the farthest south-following opening E. 10^h 20^m the shallow B is completely run into the shallow about D; and the shallow A is grown broader towards F. 11^h 30^m the shallow B is so completely joined to the shallow D, that it appears as if it had not come from the opening C. The shallow A now ends in a sharp point, Fig. 15. 12^h 50^m the shape of the shallow A is no longer pointed, but very broad at the end, and there is a new branch breaking out at G, Fig. 16. These changes seem all to denote that the shallows are occasioned by something coming out of the openings which, by its propelling motion, drives, away the luminous

they are caused by the propelling gas which produces the openings.

luminous clouds from the place where it meets with the least resistance; or which by its nature dissolves them as it comes up to them. If it be an elastic gas, its levity must be such as to make it ascend through the inferior region of the solar clouds, and diffuse itself among the superior luminous matter. 1^h 10^m the new branch G increases, and the openings C D E are enlarged. A new branch is also breaking out from the shallow about E. It is marked H in Fig. 14, and denoted with points. These changes seem to prove that the same gas which diffuses itself over the shallows, has forced open the passages at first, and is now widening them. Hence the increase of the openings is an additional circumstance which points out the cause of the shallows. 1^h 20^m: from the shallow of a very large preceding opening, which is in an increasing state, are lately projected three small branches, *a b c*, Fig. 17. 2^h 30^m the vacancies between the three small projecting shallows are now filled up by the same cause that occasioned them, so as to have given them the shape of an uniform but broader shallow on the side where the points came out.

The shallows have none of the appearance called corrugations, but are tufted. The close connection of the tufts makes them appear as if in every vacancy there were clouds under clouds, that prevented our looking far into them. The decay of the shallows appears to be produced by the encroachment of the luminous clouds on all sides, in consequence of the diminution of the energy which caused them.”

Particular appearance of the shallows. They are tufted like masses of dense clouds.

Of Ridges.

Ridges are elevations above the general surface of the luminous clouds of the sun. The length of one of the longest was found to be about 75,000 miles. They generally surround the openings, though they are often seen in places where there are no openings. They are soon dispersed. From the appearances, the author thinks it probable that the luminous matter is disturbed at top by the transparent elastic fluid which issues from the openings, or that it may act below the luminous clouds, so as to lift them up or increase their mass.

Ridges, or elevations of the luminous clouds of the sun.

Of Nodules.

Nodules, or small elevations of the luminous matter.

Nodules are small, but highly elevated luminous places. They may be ridges four shortened.

Of Corrugations.

Corrugations are smaller elevations and depressions of the luminous matter.

The corrugations consist of elevations and depressions. They have a mottled appearance, consisting of dark and bright places. Many of the dark places are not round, but a little extended in different directions, and appear to be lower than the bright places. On favourable days the corrugated surface presents its elevations and depressions as distinctly as the rough surface of the moon. They extend over the whole surface of the sun. Dispersed ridges or nodules make corrugations. The corrugations change their shape and situation; they increase, diminish, divide, and vanish quickly. Fig. 18 exhibits a small sketch of the place of phenomena observed by the author and Dr. Wilson, in which the rapid changes were correspondently observed.

Of Indentations.

Indentations of the luminous matter.

The dark places of corrugations are indentations. That they are not much depressed, is deduced from their visibility pretty near the margin of the sun. The indentations go down at the sides like circular arches, but their bottoms are occasionally flat. See Fig. 19. Some indentations have no openings, others have. The corrugations are of all shapes, chiefly lengthened. The indentations are of the same nature as shallows; are of different sizes; sometimes containing very small openings, and sometimes changing to openings. They are extended over the whole surface of the sun, and with low magnifying powers they appear like points.

Of Pores.

Pores.

The low places of indentation are pores. They occasionally increase, and become openings: and frequently they vanish in a short time.

Of the Regions of Solar Clouds.

The shining matter of the sun cannot be a liquid or a gas;

Dr. Herschel observes that the phenomena before described could not appear, if the shining matter of the sun were a liquid, because by the laws of hydrostatics the openings, shallows,

shallows, indentations, and pores would be filled up, and the ridges and the nodules would subside almost instantly. Whereas many openings have been known to last for a whole revolution of the sun, and extensive elevations have remained supported for several days. Still less could these phenomena consist with the supposition of elastic fluidity. It remains, therefore, says he, for us to admit this shining matter to exist in the manner of empyreal luminous or phosphoric clouds, residing in the higher regions of the solar atmosphere. In support of this notion he gives the following observations.

Changes in the solar clouds happen continually. There are two different regions of solar clouds, the lower of which consists of clouds less bright than those which compose the upper stratum. The inferior clouds are opaque, the colour of all the shallows being the same, and consequently not affected by the cause which acts upon the upper stratum when shallows are generated. By a contrivance for the use of his photometer, he found that if the superior self-luminous clouds of the sun throw the same quantity of light on the inferior region of opaque solar clouds as they send to us, those inferior clouds, of which the shallows are composed, reflect about 469 rays out of 1000 they receive; but that the solid surface of the sun seen in the openings reflects no more than about 7. The indentations are planetary clouds, reflecting light through the open parts of the corrugations, and those opaque inferior clouds probably suffer but little of the light of the self-luminous superior clouds to strike the body of the sun. The motion of the inferior clouds is seen through the openings as they pass along. The superior clouds are also seen to traverse the same apertures previous to their closing.

That the planetary clouds are of eminent use, is inferred by recurring to the phenomena before recited. The planetary atmosphere of the sun, its great height, its density, as inferred from the power of gravitation, which is known to be twenty-seven times stronger at the sun's surface than with us, and must accordingly condense the atmospheric gases, its agitation similar to the winds of our planet, and the clear atmospheric space beneath the shallows, are among the facts upon which our philosopher extends his discussions. He repeats and amplifies his remarks respecting the operation of the gas, which is stated to pass from the sun itself upwards to the region of

and consequently it must form clouds.

Rapid sketch of the phenomena of the sun's surface.

Luminous clouds.
Dark or planetary clouds.

Other facts and appearances.

Use and constitution of the solar clouds.

the clouds, so as to generate pores, corrugations, and all the solar changes, and most probably to maintain phenomena in the sun's atmosphere, which in ours would be mere transitory corrugations, like those of the aurora borealis, but are there, on account of the greater density, so compressed as to become much more efficacious and permanent. If this account of the solar appearances shall be well founded, he concludes that there will be no difficulty in ascertaining the actual state of the sun with regard to its energy in giving light and heat; and that nothing will now remain but to decide the question which will naturally occur, whether there be actually any considerable difference in the quantity of light and heat emitted from the sun at different times. To ascertain this he has recourse to his journal.

Inquiry whether the energy of the solar heat and light be dependent on these phenomena?

Journal of solar observations.

Opinion that the seasons are governed by the variation in the sun.

Recurrence to Lalande for solar facts, and to Adam Smith for the fertility of the seasons.

In the first place he gives a set of observations, in which the signs of scarcity of luminous matter in the sun were apparent; namely, in general a deficiency of the luminous or empyreal clouds, no ridges, nodules, corrugations, or openings. This period lasted from the year 1795 to 1800. A second set, commencing in the year 1800, affords indications of a contrary nature. He expresses his opinion that the character of the seasons may be greatly dependent upon these phenomena. But, in order to ascertain by some correspondent event or consequence that the seasons have been most productive when the solar spots were abundant, he recurs to the astronomy of Lalande for the solar appearances, and to the table in Adam Smith's *Wealth of Nations* for the prices of wheat during the same periods. The results are, upon the whole, favourable to his theory; though every cautious investigator into the laws of the universe must see that it is greatly in want of the support of observation in both respects. The Doctor, with his usual candour, states some of the difficulties of his subject, and concludes by adding, that his prediction of plentiful harvests from the present thriving state of the solar constitution ought not to be relied on with more confidence, than the facts and arguments he has presented may entitle it to. And from motives of the same kind, I have also taken the liberty to condense this part of his paper rather more than the other.

IN a subsequent paper of the same volume, Dr. Herschel ^{Subsequent ob-} gives a number of additional observations, made in the spring ^{servations.} of 1801, by which it appears that the sun continues to exhibit symptoms of a plentiful emission of light. He strongly ^{Suspicion that} suspects that one half of our sun is less luminous than the ^{the sun has a} other, and that its variable lustre may possibly appear to other ^{bright and an} solar systems as irregular periodical stars are seen by us; but ^{obscure side.} whether this arises from some permanent construction of the solar surface, or be merely an accidental circumstance, must be left to future investigation.

He takes notice that we need not in future be at a loss ^{Judgment of the} with regard to the current temperature of this climate, as ^{seasons by ther-} the thermometrical observations, regularly given in the Phi- ^{metrical re-} losophical Transactions, afford a proper standard of com- ^{gisters.} parison with the solar phenomena.

In this paper also, with a drawing, is described a method ^{Very advantage-} of substituting liquids instead of dark glasses, for moderating ^{ous use of liquids} the solar light and heat in telescopes. It is a square trough, ^{instead of the} closed at two opposite ends by well polished parallel plane ^{dark glasses of} glasses. On one side of this trough is a small handle, and on ^{telescopes.} the other a lip or spout for pouring out any portion of the liquid when the rest is to be diluted. The trough is made to ^{Apparatus.} fit into an excavation in the eye tube of the telescope, and in this situation the solar rays must pass through the liquid therein contained before they arrive at the eye. By colouring the fluid, the observer has it in his power to soften the light at pleasure; and water keeps off the heat so as to prevent the least inconvenience. It is easy to make trial of a variety of fluids in this way. Among other mixtures, the Doctor found that ink, diluted with water, and filtered through paper, shewed the solar image as white as snow, and very distinct. Through this mixture he could observe the sun in the meridian for any length of time without danger to the eye, or to the glasses, with a mirror of nine inches in diameter, and the eye-pieces open, as they are used for night observations.

IV.

Observations and Experiments upon Dr. James's Powder, with a Method of preparing, in the humid Way, a similar Substance.
By RICHARD CHENEVIX, Esq. F.R.S. M.R.I.A.*

Preliminary remarks.

AFTER the observations and experiments made by Dr. Pearson, to investigate the nature of Dr. James's powder, and presented by him to this Society, very little remained to be effected or desired, towards a further knowledge of the subject. But those very experiments served to suggest, that the mode of preparation was far from being the best that the present improved state of chymical knowledge might afford; and that, in all probability, a less defective composition might result from a process more conformable to some improvements, which of late have been advantageously applied to pharmaceutical chymistry.

It may be laid down as a general principle, that, in delicate experiments, whether analytical or synthetical, fire (that potent and once believed to be universal agent) is too precarious in its means, and too uncertain in its application, to be employed with full and constant success. And, if it is still resorted to, the advantage of promptness, and a remnant of ancient custom, are the principal reasons. But, where other methods can be devised to effect the same combinations, (and the humid way offers many,) every person conversant in chymical knowledge will allow the benefit of adopting them. The recent improvement in the mode of preparing calomel, is a striking example of such salutary corrections being successfully introduced.

The method of preparing James's powder, or *Pulvis Antimonialis*.

A few observations upon the formula according to which Dr. James's powder, or the *Pulvis Antimonialis*, is prepared, and upon some properties of antimony, will place this assertion in a more prominent point of view.

In order to prepare this powder, we are told to take equal weights of bone or hartshorn shavings and crude antimony, and calcine them together, at a high temperature: in other words, to take phosphate of lime, which already contains a great excess of lime, and add to it an oxide of antimony. In

* Philof. Transf. 1801.

this process, it has been supposed, that the phosphoric acid of the bone or hartshorn will saturate, not only the lime with which it was originally combined, but, in addition to it, a new portion of metallic oxide, and a new portion of lime. For, what little sulphuric acid might, during the process, have been formed by the combustion of the sulphur of the crude antimony, is dissipated, at a much lower temperature than that to which the powder is exposed.

Every oxide of antimony with which we are acquainted, is volatile at a high degree of heat: it would therefore be hazardous to assert, that it is possible to preserve always the same proportion of antimony, whatever care may be employed in directing the operation; and, a dissimilarity in the chemical result, must necessarily be attended with uncertainty in the medical application.

It contains an uncertain dose of antimony;

To this property may be added another, no less conducive to error. That portion of oxide of antimony which is not volatilized, becomes, in a great measure, insoluble in all the acids. What the effect of the gastric juice may be, upon a substance which resists the action even of nitro-muriatic acid, it is not my purpose to determine. It is sufficient for me to say, that, as the quantity of insoluble matter, in a given quantity of Dr. James's powder, prepared at different times, may vary, the effect of any dose also may differ, according to the proportions of soluble and insoluble matter.

and the oxide varies in its solubility.

I look upon it as a fortunate circumstance, that those experiments and observations which I mentioned in the beginning of this paper, existed as a standard to which I might refer my own attempts, and by which I might estimate their validity. Dr. Pearson has proved, (as by my own experiments I have found,) that in Dr. James's powder about 28 per cent. resisted the action of every acid. In examining some of the *Pulvis Antimonialis* of the London Pharmacopeia, I found the average quantity of insoluble matter to be about 44 per cent. This proportion, however, was liable to considerable variation.*

Facts in proof.

* I find, from the information of several medical gentlemen, that the *Pulvis Antimonialis* is generally considered as stronger than Dr. James's Powder. This seems rather extraordinary, when we consider that the quantity of insoluble matter is greater in the former than in the latter; and would almost lead us to suspect it to be the active part of the medicine.

The

Whether this powder be a ternary compound.

The powder here treated of is denominated, by Dr. Pearson, a triple salt, or a real ternary combination of a double basis, (lime and antimony,) with phosphoric acid. What I have mentioned, with regard to the quantity of acid contained in bone or hartshorn, as being too small to saturate a new portion of these bases, may throw some doubts upon the possibility of any such combination in the present case. But I have made some more direct experiments, which tend to prove, that no such combination does exist.

It contains no phosphate;

I took some white oxide of antimony, (formerly called Algaroth Powder,) precipitated by water from muriate of antimony, and heated it for a long time with phosphoric acid. I decanted the liquor, and washed the powder that remained. No antimony could be found in the liquor; nor could any traces of phosphoric acid be detected in the residuary oxide of antimony. I then took a solution of muriate of antimony, and divided it into two equal parts: into one, I poured distilled water; and, into the other, a solution of phosphate of soda. In each liquor, a copious precipitate was formed; which precipitates, after being well washed, were dried. The weight of both was the same; whereas, it is evident that, had any phosphoric acid been combined with the oxide, there would have been an augmentation of weight, in that which was precipitated by the solution of phosphate of soda. This precipitate likewise, upon examination, gave no traces of phosphoric acid. From these experiments it appears, that there exists no combination, which can be denominated a phosphate of antimony.

neither does it appear to be antimoniate of lime.

To attempt an explanation of the real nature of the powder here spoken of, I had recourse to some experiments of Mons. Berthollet. By detonating sulphuret of antimony and nitrate of potash, in a crucible, he obtained a mass, which he reduced to powder, and washed. The liquor gave, upon evaporation, a crystallized salt, which M. Berthollet terms an *antimoniate of potash*. I never could succeed in any attempt to form a similar combination between the above white oxide of antimony and potash, owing, I believe, to the small quantity of oxygen contained therein, compared with that which is combined with the oxide obtained by detonation. I cannot therefore say, that the powder in question is, in any degree, what M. Berthollet would call an *antimoniate of lime*.

But,

But, be the state, whether of mixture or of combination, what it may, my purpose is to endeavour to produce a substance, which, from its more certain mode of preparation, may be more equal and constant in its effects.

Dissolve, together or separately, in the least possible portion of muriatic acid, equal parts of the forementioned white oxide of antimony and of phosphate of lime.* Pour this solution gradually into distilled water, previously alkalized by a sufficient quantity of ammonia. A white and abundant precipitate will take place, which, well washed and dried, is the substitute I propose for Dr. James's powder.

New process for a combination of antimony of more constant effect.

The theory of this precipitation is so clear and simple, that it does not require any comment. It may be useful, however, to those who wish to make this preparation, to remark, that it is absolutely necessary that the solution of phosphate of lime and of oxide of antimony, in muriatic acid, should, after being well mixed; be poured *into the alkaline liquor*, in order to obtain a precipitate homogeneous throughout the operation. For, should the alkaline liquor be poured *into the acid solution*, the water of the former would act upon the entire mass of oxide of antimony, while the alkali would precipitate the phosphate of lime only as it saturated the acid which held that salt in solution: thus, the precipitate would contain more antimony in the beginning; and, towards the end, the phosphate of lime would be predominant. For the same reason too, a pure alkali is preferable to its carbonate; for the carbonic acid disengaged, would retain in solution a portion of phosphate of lime.

Remarks.

* In order to procure the phosphate of lime, I dissolved in muriatic acid, a quantity of calcined bone, and precipitated by ammonia, in its state of greatest causticity. By this means, the excess of muriatic acid, which held in solution the phosphate of lime, is saturated, and the phosphate is precipitated; but no muriate of lime is decomposed, if the ammonia is quite free from carbonic acid. This is the most direct method of obtaining phosphate of lime pure. This salt is not decomposed, as some have asserted, by muriatic acid, but merely dissolved by it. I have been induced to state fully these particulars, because, from the beneficial effects of this salt in the treatment of rachitis, as proposed by M. Bonhomme, (*Annales de Chimie*, Vol. XVIII. p. 113,) it may become of general use. The oxide of antimony, I obtained by precipitating, by water, the common butter of antimony of the shops.

It is probably a mixture.

Whether this composition be a chymical combination or a mixture, I will not take upon me to determine; but, for the reasons above mentioned, in speaking of Dr. James's powder, I believe it to be merely a very intimate mixture. At all events, it must be more homogeneous than any that can be prepared in the dry way. It is entirely soluble in every acid that can dissolve either phosphate of lime or oxide of antimony separately; and, to have it constantly and uniformly the same, no further address, in preparing it, is required, than to avoid the errors I have mentioned.

Stronger preparation.

As, after some medical trials of the powder, it was suggested to me, that it might be advantageous to render it somewhat stronger, I prepared another portion, by taking two parts of oxide of antimony and but one of phosphate of lime, and precipitating as above described. The medicinal power was then considerably increased.

Medical testimony of its use.

Dr. James's powder is a medicine which has been so long in use, and is so deservedly ranked among the most valuable we possess, that every attempt to render the process for preparing it more simple and more certain, must be allowed to be of some importance. But, whatever reason there was to think, by arguing upon its chymical properties, that I had really succeeded in improving its medicinal virtues, it still remained to be proved, by actual experiment, that the hoped-for success was not merely conjectural. To ascertain this, I gave some of my powder to Dr. Crichton, Dr. Babbington, and Mr. Abernethy; gentlemen whose extensive practice and acknowledged skill sufficiently enabled them to judge of its medical properties. They all concur in opinion, that, in its general effects, it agrees with Dr. James's powder and the *Pulvis Antimonialis*; but, that it is more mild, and consequently may be given in larger quantities, seldom producing nausea or vomiting, in doses of less than eight or ten grains.

V.

Construction of an Hydraulic Apparatus, which by Means of the Syphon raises Water above its level, and performs its Alternations without Attendance. By Mr. Wm. CLOSE.

To Mr. NICHOLSON.

SIR,

Dalton, Nov. 6, 1801.

AT the time when I wrote to you on the application of the syphon to raise water above the reservoir, I could find no easy method of making the instrument afford an equable supply without attendance. Since then, however, I have thought of a combination for the purpose, applicable to any height under an elevation of thirty feet; and another to raise water below the reservoir, independent of the pressure of the atmosphere.

I send you a drawing, and description of each.

Plate III. exhibits a representation of the apparatus for raising water above the reservoir. An air pipe is inserted into one side of the turn of the syphon SS, and a small plate is fixed on the side of its aperture opposite the shorter branch to obstruct part of the current. At some distance from the syphon this pipe divides into two branches, 2, 3, which lead to two vessels A and B. At the separation is fixed a cock of such a construction, that the air pipe 1 can only communicate with one of its branches at once. The barrel of the cock, or that part which is represented by short radial lines in the section of this part of the apparatus, has three lateral openings: the plug or key which moves within the barrel contains a duct or channel, which, instead of passing straight through it, is turned with such a bend, that when one end of it is under the opening of the air pipe, the other will be opposite the orifice of one of the pipes 2, 3. The communication from the air pipe to either of its branches is therefore completed by about a quarter of a turn.

The vessels A and B have each a pipe with a valve at its lower end, connected with the cistern CC, to carry up water, and two other pipes, one to let out the raised water, and the other to take in air at the same time. The air pipe need only

be

be very small, but the water pipe must be wide enough to empty the vessel in the same space of time that it was filled. Each has a valve, but as they are all upon the same level, only the valves of the two water pipes are represented. All these valves are closed by weights. Between these vessels is represented a wheel, with a weight suspended on one side, and the vessel E on the other. Its rim has a groove, for the chains or cords, and one side is formed into teeth, to act upon another toothed vessel above, which moves the cock in its axis.

The vessel D receives water from the cistern C C, through an aperture of a proper width, and is emptied by a syphon as often as the water rises to a certain height.

The syphon S S is about six inches in diameter; its shorter branch rises thirty feet above the reservoir, and its longer branch reaches five or six feet below the surface of the water.

Its effects.

Suppose now that this instrument is set to work and supplied with a sufficient quantity of water. The cock in the air pipe I above the vessel A must be opened, and the vertical pipes A C, and B C, must be filled with water, by opening a very narrow passage between the air pipe and each of its branches, while the valves of the vessels are closed.

This mode of proceeding is advisable to prevent the sudden pressure of the atmosphere from forcing the air out of the empty pipes, with such rapidity as would destroy the operation of the syphon. After this, if all the valves are in good order, and all parts of the apparatus complete, no further attention will be necessary.

The periphery of the lower wheel moves between the valves of the vessel A on one side, and those of B on the other, and has a claw or pin to depress each in due order. The weight suspended upon the lower wheel opens the valves of B, and by the assistance of both wheels opens a communication between the air pipe I, and the vessel A, whose valves have previously closed their pipes. The pressure of the atmosphere accordingly fills A with water, and the air it contained is carried down the stream through the longer branch of the syphon. About this time the vessel D is filled to a level with the bend of its syphon which conveys water in the vessel E. This last vessel being filled, overbalances the weight, and moves the two wheels; the valves of the vessel B are closed by their respective weights, and the rarefying tube is made

to

to communicate with the branch 3; the aperture of the key duct, which before corresponded with the end of the branch 2, is now placed under the orifice of the rarefying tube, and the opening which was there before, is turned to the branch 3.

At the time when all communication between the vessel and syphon is intersested, one of the claws or pins on the farther side of the lower wheel, opens the valve of the air pipe in the vessel A, and immediately after it the valve of the pipe for letting out water is depressed by a claw on the nearer side. This last valve will make little resistance, as the whole pressure of the atmosphere was removed by opening the small pipe first; for this purpose it has a separate valve.

The raised water flows out of A while B is filling.

When the vessels D and E are emptiest, the large weight moves the wheels and the cock; the valves of B are opened in the same order as those of A, which being again connected with the syphon, is filled while B is emptied.

In actual work the receptacle of raised water must be placed under the vessels, the axis of the lower wheel may extend across the receptacle, and have two arms or levers, fixed in a proper position to depress the valves, while the wheel itself will move on the outside. The key or plug of the cock turned by the axis of the higher wheel, should move very true in its barrel. The higher wheel should be made light if the key of the cock is fixed fast to its axis. The key or plug should be frequently taken out and rubbed with tallow; its tightness may be adjusted by a screw fixed in a proper frame and moved by a weight. When any repair is requisite, the cock in the air pipe above A must be turned.

Remarks and observations.

A syphon six inches in diameter will require its air pipe to be about one inch and a half in diameter.

By a syphon of these dimensions water may be raised to the height of sixty feet, if the vertical water pipe of the vessel B, be placed in the cistern which receives the raised water from A, and the branch of the air pipe 3 be carried to the top of the vessel B. Both the vessel and the air pipe should be made something less on account of the greater body of air to be rarefied. The air pipe should reach considerably above the vessel, or it must have a float valve, to prevent any waste of the raised water.

If

If the lower end of the pipe B C was inserted into the lower side of the vessel A, the water might be forced out of this vessel into the higher, by admitting the pressure of the atmosphere. The higher water pipe however, should descend considerably below the bottom of the vessel, and its valve should be always kept in good order, or part of the raised water will be drawn down again when the air in the lower vessel is rarefied. Indeed if we can insure the tightness of the valves, water may be carried through any number of vessels, without being delivered into any cistern before the requisite height is obtained.

Construction of the apparatus for raising water below the reservoir.

The apparatus represented in Pl. III. may be used to raise water below the reservoir, if the vessels and their water pipes are sufficiently settled, and the air pipe 1 placed in a vertical position; but for this purpose the combination represented in Pl. IV. will be preferable. It is an inversion of the former method. A stream of water falls down the pipe L, passes through the vessel V, and ascends again through the shorter pipe S. When there is a sufficiency of water to fill the longer pipe, the stream flows through the apparatus with considerable celerity. The longer pipe L having several small holes at the turn near the higher end, a quantity of air is drawn into the stream, and descends into the vessel V, where it quits the current, rises to the higher part of the vessel, and depresses an equal bulk of water, which is carried through the pipe S. This explains the principle.

The air however is not suffered to collect in the vessel V, but is conveyed through the pipe 1, into one of the vessels A B, previously filled with water, which it forces into the stream. The alternate connection of 1, 2, and 1, 3, is completed by a cock of the same construction, as is described in the explanation of Pl. III. and by the same kind of machinery.

The lower parts of the apparatus, Pl. IV. to above the vessels A B, are immersed in water. At present the vessel V communicates with the vessel A; the water will accordingly descend out of A through the tube below 2, which has a valve opening downwards. A small conical valve at the lower end of a pipe inserted into the top of B, being opened immediately before the communication between V and A is completed, the condensed air rushes out of B, and water enters through an aperture under that letter, while the valve under 3 is closed.

When the vessel B is filled, and A is emptied, the cock in the air pipe begins to be put in motion, but before the tube I is connected to the branch above 3, the small conical valve above B closes its air pipe; the valve under B being now closed by the pressure of the water in the tubes L S, the water in B is forced down the pipe under 3, and carried away with the stream: the condensed air is let out of A, and this vessel replenished with water.

The air which is carried down the stream while it can enter into neither vessel above, will collect in V, until an avenue to one is completed, through which it will rapidly ascend. If the engineer does not like the construction of the cock I have recommended, its place may be supplied by two of the common kind, with adjusting pieces upon their keys.

The condensed air collected in the vessel V, may be applied to the purpose of raising water either above the reservoir C C, or below the vessel V, merely by forcing the air out of V into the vessel containing the water, by the pressure of the water in the pipes L S.

The apparatus will begin its operations without any trouble; the capacities of the vessels A B are indeterminate; and if the higher orifice of the pipe S be contracted, the machine will work with a less quantity of water than it may be calculated to receive. The vessels A and B however, should always be filled completely with water before the admission of the condensed air, otherwise the quantity of raised water will decrease.

A model was constructed to illustrate the principle: the Experimental trial. two water pipes were about half an inch in diameter, and only one small hole was made at the higher end of the longer. Into the top of the vessel represented by V, was soldered two small pipes, which were surrounded by a little thread, and inserted into the neck of a small glass bottle. The vessel V and the lower parts of the water pipes were plunged into a vessel of water, until all the air in the apparatus below the surface was expelled. In this situation the bottle, previously filled with water, was fixed upon the pipes above V. The model being lifted out of the water, and the longer pipe fixed to a small cistern, the remaining parts of the water pipes were carefully filled; a sufficient supply was let into the cistern, and the higher

higher orifice of S was opened. When the stream had acquired its full force, bubbles of air entered the bottle, and the water was quickly expelled.

I am, SIR,

Your humble Servant,

WILLIAM CLOSE.

ERRATA in the Paper on Wind Instruments. (Philos. J. V. 213.)

Page 217 line 23, erase *major*.

— 219 — 44, for *fifth* read fourth.

— 221 — 11, change G, a, B, into G, A, B.

VI.

Outline of the Properties and Habitues of the Metallic Substance, lately discovered by CHARLES HATCHETT, Esq. and by him denominated Columbium.

ON the 26th of November last a Paper was read at the Royal Society, announcing the discovery and investigation of the properties of what appears to be a new metal; and as by the course of publication it must be several months before it will appear in the Transactions, I shall present my readers with the following outline :

History of the mineral.

1. The mineral was sent with some iron ores to Sir Hans Sloane by Mr. Winthrop of Massachusetts, and there is therefore every reason to believe, that it came from some of the iron mines in that province.

External character.

2. It is heavy, and of a dark grey nearly black; it in some measure has the appearance of the Siberian chromate of iron.

Habitues with acids.

3. The nitric, muriatic, and sulphuric acids act but very feebly upon the mineral; of these however, sulphuric acid produces the greatest effect, and dissolves some iron.

With potash by fusion, and subsequent digestion in muriatic acid.

4. When melted with five or six parts of carbonate of potash it is partially decomposed; but in order to effect a complete decomposition, the ore must be alternately melted with potash, and digested with muriatic acid, which takes up the iron.

5. During

5. During the fusion, carbonic acid is expelled, and the pot ash becomes partially neutralized by a metallic acid, which may be separated after solution in water, by nitric acid added to excess, and then appears in the form of a copious white flocculent precipitate. The potash holds a metallic acid; precipitable by nitric acid.
6. The ore consists of more than three fourths of this substance combined with iron. This acid very abundant
7. The white precipitate is insoluble in boiling nitric acid, and remains perfectly white. Insoluble in nitric;
8. Boiling muriatic acid dissolves it when recently separated from pot ash. But soluble in muriatic;
9. Sulphuric acid when strongly heated also dissolves it. And sulphuric acid.
10. The acid solutions when saturated by alkalis afford white flocculent precipitates; prussiate of pot ash forms an olive green ditto; tincture of galls, deep orange coloured ditto; water also when copiously added to the sulphuric solution precipitates this substance in the state of sulphate, which as it becomes dry, from white, changes to blue, and lastly to grey. Precipitable.
11. Zinc forms a white precipitate.
12. The white precipitate combines with pot ash and soda, both by the dry and humid ways; it expels carbonic acid, and with pot ash forms a glittering scaly salt, which has much the appearance of the boracic acid. Neutral salts and their affections.
13. Acids separate it from the fixed alkalis, and when added to excess do not dissolve it unless heated, but even then nitric acid has no effect.
14. The same is observed when alkalis are added in excess to the acid solutions.
15. Hydro-sulphuret of ammoniac added to the alkaline solutions forms a chocolate coloured precipitate.
16. Ammoniac will not combine with the white precipitate.
17. When prussiate of pot-ash, or tincture of galls, are added to the alkaline solutions, no effect is produced till an acid is added, and then the usual olive green and orange coloured precipitates are obtained.
18. The acid and alkaline solutions are colourless.
19. The white precipitate will not combine with sulphur in the dry way.

20. It forms a purplish blue glass with phosphate of ammonia.

21. It reddens litmus paper.

22. It appears to be of extreme difficult reduction.

Conclusion.

From the above properties it appears to be an acidifiable metal different from those already known, and it has been therefore distinguished by the name of Columbium.

VII.

On the Sebacic Acid, or Acid of Fat. By CIT. THENARD *.

Authors who have treated the subject.

A GREAT number of chemists have successively written on the sebacic acid. Grutmacher appears to have been the first who has spoken of it; it has since been treated of by Rhades, Knap, Segner, and Haller, who have confirmed and augmented his experiments. Crell has given us several processes for obtaining this acid in a state of purity, and has subjected it to a number of experiments, the results of which Citizen Guyton has inserted in the *Journal de Physique*, (Vol. XVIII. pages 110 and 383, and Vol. XIX. page 384.) Bergman has ascertained the order of the attraction of this acid for the salifiable bases. Citizen Guyton has handled the same subject, and discovered several errors which had escaped the notice of this chemist.

Object of proof by them differs considerably from the result of the present experiments.

The object of all the experiments which I have just mentioned, is to prove that the product of the distillation of fat contains a peculiar acid, of extreme volatility, and of such a poignant and suffocating nature, that it cannot be respired without some degree of danger. Those of which I am about to give an account prove 1. That this product actually contains a peculiar acid, which however, so far from being volatile, odorous and suffocating, is on the contrary solid and inodorous; 2. That it also contains acetous acid; 3. That this new acid has no part in the smell of distilled fat; 4. That by all the processes that have hitherto been employed for extracting the sebacic acid, nothing is obtained but a foreign acid, and that consequently the sebacic acid has not yet been known.

* Communicated to the National Institute of France, and inserted in the *Annales de Chimie*, XXXIX. 193.

A. Processes for obtaining the Sebacic Acid, and Characteristic Properties of this Acid.

HAVING distilled a considerable quantity of the fat of pork, I treated the product, at several times, with hot water, and poured acetite of lead into the liquor; a flaky precipitate was formed, which I collected and dried, after which I put it, together with sulphuric acid, into a retort and heated it. The liquid of the receiver had no character of acidity; but in the retort a melted substance floated at the top, analogous to fat, which I carefully separated, and after having washed it well, boiled it with water. By the aid of the action of the heat, the water totally dissolved it, and by refrigeration crystalline needles were deposited, having little consistence: these needles were acid, and possessed properties altogether peculiar to themselves. In order to assure myself that they were not the product of the sulphuric acid, I treated distilled fat with water; and having filtrated and evaporated the liquor, I obtained needles possessing precisely the same properties.

In order to procure this acid, we may also, if we think fit, after having treated the distilled fat with water, saturate the filtrated liquor with pot ash, evaporate it, and pour into it a solution of lead. A precipitate is formed, which is a sebate of lead, that is to be treated as above with the sulphuric acid. These are the three methods which may be employed in order to obtain the sebacic acid: its properties are the following:

It is without smell; its taste is slightly acid: it melts like a kind of fat; it considerably reddens the tincture of Tournesol; it is much more soluble in a hot than in a cold temperature. Boiling water, saturated with the sebacic acid, becomes solid by refrigeration; alcohol dissolves a large quantity of it; it crystallizes in small needles; by using proper precautions, we may obtain it in the form of long, large, and beautiful lamellæ, of a very brilliant appearance; it precipitates the acetite and the nitrate of lead, the nitrate of silver, the acetite, and the nitrate of mercury; it saturates the causticity of the alkalies, with which it forms soluble salts; with pot ash it produces a salt which does not attract moisture from the atmosphere, which has but little taste, and which, if we pour upon it sulphuric, nitric, or muriatic acid, becomes turbid, and deposits

Pork fat was distilled, washed with hot water, and acetite of lead poured in. The precipitate was dried and then distilled with sulphuric acid. No acid came over; but a matter resembling fat, floated in the retort. This being boiled with water proved soluble and crystallized by cooling. It is a peculiar acid; and may be obtained by washing distilled fat with water, without the use of sulphuric acid.

On the aqueous solution from distilled fat may be saturated with pot ash, then evaporated and decomposed by acetite of lead. The sebate of lead may then be made to yield its acid by the stronger attraction of the sulphuric.

Sebacic acid has no smell; is slightly sour; melts like fat; reddens turnsol; is more soluble in hot than cold water, and so much in the latter as to become solid by cooling. Alcohol plenti-

fully dissolves it.
Crystallizable.
Its peculiar attractions and habits.

sebacic acid; when its solution is concentrated and mixed with one of these acids, it becomes solid; finally it does not render turbid the waters of lime, barytes and frontites. These properties distinguish it from all the other acids, and evidently prove that it is an acid *sui generis*.

B. *Means of separating the Acetous Acid from the Product of the distillation of Fat.*

The aqueous solution from distilled fat contains acetous or sebacic acid, more largely the greater or less the heat of distillation. The former is separated by neutralizing with potash, and distilling with sulphuric acid.

THE product of the distilled fat is treated with water; the liquor is saturated with potash, and evaporated. When the substance is dry, it is introduced into a retort with dilute sulphuric acid, or phosphoric acid, and distilled: an acid is obtained, which has all the characters of acetous acid; with potash it forms a foliated salt. This salt is susceptible of being melted by means of heat; when exposed to the air, it deliquesces speedily and completely; its taste is extremely pungent; with a solution of nitrate of mercury, it forms a precipitate crystallized in the form of spangles. When sulphuric acid is poured upon it, acetous acid is disengaged in abundance. Sometimes the water with which the product of the distilled fat has been treated, contains hardly any thing else than acetous acid, so that in order to obtain acetite of potash, nothing more is necessary than to evaporate the liquid. The quantity of sebacic and of acetous acid formed in the distillation of fat, varies in proportion to the lesser or greater degree of heat.

C. *Examination of the Odorous Matter, and of the distilled Fat.*

The pungent odour of distilled fat is not produced by an acid.

I INTRODUCED fat, which had just been distilled, and the smell of which was extremely pungent, into a tubulated retort. I adapted to the neck of the retort, a receiver which contained tincture of Tournesol. Having distilled with a gentle heat, I thereby filled the receiver with a strong odour, and yet the colour of the tincture was not changed—a convincing proof that the smell of distilled fat is not owing to an acid; besides, if this smell depended upon an acid, it would probably disappear upon placing it in contact with the alkalis, as the acid would then be absorbed; but this does not happen. We must therefore conclude, that it depends upon a portion of the fat, converted into gas, and undoubtedly changed in its nature.

D. *Examination*

D. Examination of the Processes that have hitherto been employed for obtaining Sebacic Acid.

CRELL, in order to separate the sebacic acid from the product of distilled fat, first added to it a certain quantity of potash, after which he filtrated and evaporated it. As the salt which he obtained was mixed with oil, he calcined it, after which he re-dissolved it in water, and evaporated the solution. By this means he obtained a salt of considerable whiteness, and of a foliated texture; this he introduced into a retort, with sulphuric acid, and distilled it, whereby he obtained a pungent and fuming acid. But as this process appeared to him to be an inconvenient one, he had recourse to the following :

Perfuaed that the acid of fat existed ready formed in the fat itself, and was not a product of distillation, he prepared a soap with fat and potash, and treated this soap with water, in order to dissolve the sebate of potash formed in it. But as the water, besides the sebate of potash, dissolved also a certain quantity of fat combined with potash, he added to the solution of this sebate of potash and of this soap, a sufficient quantity of alum. By this means he obtained sebate of potash, which had only an admixture of sulphate of potash; this he evaporated, poured sulphuric acid upon the dry substance, applied heat; and sebacic acid passed into the receiver.

In the chemistry of Dijon, we find a process different from that of Crell. According to this process, the fat is calcined with a certain quantity of lime, in a crucible; the substance is then lixiviated with a large quantity of water; the water which holds the calcareous sebate in solution, is evaporated; this calcareous sebate is introduced into a retort with sulphuric acid, and the sebacic acid passes into the receiver.

These three processes I have repeated with the utmost care, and have obtained the following results. The first of Crell's processes, and that of the chemistry of Dijon, afforded me an acid which has all the characteristics of the acetous acid: with potash it forms a foliated salt, which is deliquescent, has an extremely pungent taste, and on being treated with sulphuric acid, yields a large quantity of vinegar. If Crell, as he asserts, has obtained a fuming and-pungent acid, I presume that it is a small quantity of sulphureous acid, proceeding from the decomposition

Crell's process by lixiviation of fat with potash, filtration, evaporation, calcination, and resolution of the salt; and lastly distillation with sulphuric acid.

Another by forming soap and treating with water, and some alum and distilling as before.

Dijon process. Calcination of fat with lime, lixiviation, evaporation, and distillation with sulphuric acid.

Crell's first process afforded acetous acid.

decomposition of a certain portion of sulphuric acid by the fat, or of the carbone of the acetous acid disengaged from its combination.

His second by mismanagement gave muriatic acid.

In following the second process described by Crell, we do not obtain any acetous acid, but an acid, which is nothing else but the muriatic. In fact, it forms with the nitrate of silver a precipitate insoluble in an excess of nitric acid; with soda it yields cubic crystals. If we pour sulphuric acid upon these crystals, a penetrating gas is disengaged, which, on being brought into contact with the air, gives rise to vapours: the same acid, mixed with nitric acid, dissolves gold. With the oxide of mercury it forms a volatile salt; with potash it forms a salt capable of being fused without undergoing decomposition. These circumstances render it probable that Crell has employed the potash of commerce, which always contains muriate of potash; for in repeating this process with pure potash, no acid is obtained, except an almost imperceptible quantity of vinegar. This vinegar is formed by treating the fat with potash and the sulphuric acid; for fat contains no acid, not even when it is rancid. At least, I have several times treated rancid fat with water, and have uniformly obtained a liquid, which did not redden the tincture of Tournesol.

But if well performed, vinegar.

E. Recapitulation.

Enumeration and comparison of the above results.

THESE experiments prove, in my opinion, what I have advanced in the beginning of this memoir; namely, that there exists in the product of distilled fat a peculiar acid, which, instead of being volatile, odorous, suffocating, is on the contrary solid, inodorous, and fixed to a certain degree; that, besides this acid, the product of distilled fat contains acetous acid; that the sebacic acid has no share in producing the smell of distilled fat, which probably depends upon some particles of fat, converted into vapour and altered in their nature. They prove, besides, that by the processes of Crell, and by that described in the chemistry of Dijon, we obtain only the muriatic or the acetous acid; that consequently the sebacic acid has hitherto remained unknown, and that in the present state of our knowledge it is a new acid.

Hog's lard only was used.

I ought to mention, that all the experiments which I have related have been made with hog's lard, and that I have not, like Crell, varied these experiments with human fat, the marrow

marrow of beef and tallow. I propose to repeat them with these different fatty substances, and think, even according to the experiments of Croll, that I shall obtain the same results. I have not as yet examined all the properties of the sebacic acid; but it is my intention to study them with care, and give an account of them to the class.

VIII.

Improvement in the Art of preparing Radical Vinegar. By
CIT. Y. PERES, Jun.*

THE experiment which enabled me to ascertain the real difference between the acetous and the acetic acid, and afterwards to propose to the learned a new theory of vegetable acidification in general, may be of great service in the art of preparing what is termed radical vinegar; or, to speak more accurately, it ought totally to change the process used for preparing this substance.

The process at present in use, consists in distilling the acetite of copper in large spherical vessels of stone ware. By taking the greatest care, a small portion is obtained of this *radical vinegar*, so much used in medicine and for domestic purposes. The difficulty of checking the expansion of this product, is an inconvenience which, being dependent on the nature of the process itself, has at all times been felt. Some improvements have been proposed; but as the nature of the operation was not understood, these improvements produced scarcely any advantage, and the process still remains very defective. It is easy to observe, that the violent heat which is used, is much more than sufficient for depriving the acetous acid of its carbon, and that it must reduce a portion of it to its first elements. I do not hesitate to assert, that at least half the radical vinegar is lost: The large quantity of gas that is obtained, incontrovertibly proves the truth of this assertion.

I have formerly shewn, by various deductions from earlier experiments, that *radical vinegar* is nothing but acetous acid deprived of carbon. I have shewn, that the ordinary process

Observations on the distillation of acid from acetite of copper.

Radical vinegar is deduced to be acetous acid deprived of carbon.

* In a letter to the Editor of the Mag. Encyclop.

for preparing this acid effects nothing more than to abstract this excess of carbon; and I have completed my proofs, by preparing this acid myself, by a means which every one knows can have no other effect than to abstract carbon from the substances to which it is applied.

Simple process for making it. One part of sulphuric and two of vinegar are distilled.

I distilled a kilogramme of sulphuric acid with two kilogrammes of good white vinegar. I suddenly brought the mixture to ebullition, and obtained a very large quantity of radical vinegar, as white and pungent as that of commerce. This process is so simple and economical, that I thought it would be useful to extract it from the Memoirs which I have given upon this branch of chemistry, and offer it to manufacturers. I can assure them, that it will diminish the expences of the manufacture by three fourths. In fact, the sulphuric acid which remains may still serve for two more operations: but then it will be necessary to rectify the radical vinegar, for it will be found impregnated with sulphurous acid gas. It would be proper to try whether the action of manganese, which is used for ether, might not be applied to this rectification. I do not apprehend that this metal, in so high a degree of oxidation, is susceptible of being attacked by the acetic acid.

Manganese proposed.

Erroneous notion of the elective attractions of acetic acid.

An erroneous opinion obtains, with respect to the tendency of this acid to combination, which I think it incumbent upon me to refute. Chemists place it, in their tables of attractions, in a much higher rank than it will be found entitled to, upon an investigation of its properties with the least degree of accuracy. We find that it displaces only the carbonic, acetous and other weak acids. This error has arisen from the appearance of strength which it derives from the pungency of its smell. In this instance, however, the chemical properties of the substance are by no means proportionate to the impression it makes upon our senses. I shall add an observation which proves that this acid is much less powerful than is generally imagined; namely, that the vapour which it spontaneously emits, and which might seem to be its most acid portion, scarcely reddens paper tinged with tincture of tournesol. In fact it is nothing more than a modification of hydrogen, and it takes fire like ether.

Its fumes are scarcely acid, &c.

IX.

An Account of a new Eudiometer. By Mr. H. DAVY, Director of the Chemical Laboratory, and Lecturer on Chemistry to the Royal Institution.*

THE dependance of the health and existence of animals upon a peculiar state of the atmosphere, and the relations of this state to processes connected with the most essential wants of life, have given interest and importance to inquiries concerning the composition and properties of atmospheric air.

Composition of the atmosphere an interesting subject.

This elastic fluid has been long known to consist chiefly of oxygen and nitrogen, mingled together, or in a state of loose combination, and holding in solution water.

Oxygen and nitrogen.

A variety of processes have been instituted with the view of determining the relative proportions of the two gases, but most of them have involved sources of inaccuracy; and lately all, except two (the slow combustion of phosphorus, and the action of liquid sulphurets), have been generally abandoned.

The eudiometric processes commonly used are exceptionable.

Both phosphorus and solution of sulphuret of potash absorb the whole of the oxygen of atmospheric air at common temperatures, and they do not materially alter the volume, or the properties of the residual nitrogen; but their operation is extremely slow; and in many cases it is difficult to ascertain the period at which the experiment is completed.

I have lately employed as an eudiometrical substance the solution of green muriate, or sulphate, of iron, impregnated with nitrous gas; and I have found that it is in some respects superior to many of the bodies heretofore used, as it rapidly condenses oxygen without acting upon nitrogen; and requires for its application only a very simple and a very portable apparatus.

Solution of muriate, or sulphate, of iron, impregnated with nitrous gas, proposed to absorb oxygen.

This fluid is made by transmitting nitrous gas through green muriate, or sulphate, of iron, dissolved to saturation in water. As the gas is absorbed, the solution becomes of a deep olive brown, and when the impregnation is completed it appears

How made.

* Journals of the Royal Inst. p. 45.

† Dr. Priestley first observed this process: for a particular account of it, see *Researches, Chemical and Philosophical*, p. 152. Johnson.

opaque and almost black. The process is apparently owing to a simple elective attraction; in no case is the gas decomposed; and under the exhausted receiver it assumes its elastic form, leaving the fluid with which it was combined unaltered in its properties.

Eudiometer tube.

The instruments necessary for ascertaining the composition of the atmosphere, by means of impregnated solutions, consist simply of a small graduated tube, having its capacity divided into one hundred parts, and greatest at the open end; and of a vessel for containing the fluid.

Manipulation.

The tube, after being filled with the air to be examined, is introduced into the solution; and, that the action may be more rapid, gently moved from a perpendicular towards a horizontal position. Under these circumstances the air is rapidly diminished; and, in consequence of the dark colour of the fluid, it is easy to discover the quantity of absorption. In a few minutes the experiment is completed, and the whole of the oxygen condensed by the nitrous gas in the solution in the form of nitrous acid.

Maximum of diminution.

In all eudiometrical processes with impregnated solutions, the period at which the diminution is at a stand must be accurately observed; for, shortly after this period, the volume of the residual gas begins to be a little increased, and, after some hours, it will often fill a space greater by several of the hundred parts on the scale of the tube, than that which it occupied at the maximum of absorption.

Subsequent increase; and why.

This circumstance depends upon the slow decomposition of the nitrous acid (formed during the experiment), by the green oxide of iron, and the consequent production of a small quantity of aeriform fluid (chiefly nitrous gas)*; which, having no affinity for the red muriate, or sulphate, of iron produced, is gradually evolved, and mingled with the residual nitrogen.

The muriate is preferable to the sulphate.

The impregnated solution with green muriate is more rapid in its operation than the solution with green sulphate. In cases

* The decomposition of nitrous acid, by solutions containing oxide of iron, as its minimum of oxidation, is a very complex process. The green oxide, during its conversion into red oxide, not only decomposes the acid, but likewise acts upon the water of the solution; and ammoniac is sometimes formed, and small portions of nitrous oxide and nitrogen evolved with the nitrous gas.

when

when these salts cannot be obtained in a state of absolute purity, the common or mixed sulphate of iron may be employed. One cubic inch of moderately strong impregnated solution is capable of absorbing five or six cubic inches of oxygen, in common processes; but the same quantity must never be employed for more than one experiment.

A number of comparative experiments, made on the constitution of the atmosphere at the Hotwells, Bristol, in July, August, and September, 1800, with phosphorus, sulphurets of alkalis, and impregnated solution, demonstrated the accuracy of the processes in which the last substance was properly employed. The diminutions given by the sulphurets were indeed always greater by a minute quantity than those produced by phosphorus and impregnated solutions: but the reason of this will be obvious to those who have studied the subject of eudiometry. In no instance was it found 100 parts in volume of air contained more than 21 of oxygen: and the variations connected with different winds, and different states of temperature, moisture, &c. were too small, and too often related to accidental circumstances, to be accurately noticed.

Comparative experiments, or trials.

In analysing the atmosphere in different places, by means of impregnated solutions, I have never been able to ascertain any notable difference in the proportions of its constituent parts. Air, collected on the sea at the mouth of the Severn, on October the 3d, 1800, which must have passed over much of the Atlantic, as the wind was blowing strong from the west, was found to contain 21 per cent. of oxygen in volume; and this was nearly the proportion in air sent from the coast of Guinea, to Dr. Beddoes, by two surgeons of Liverpool.

No remarkable difference observable in the air of various places as to its oxygen;

If we compare these results, with the results gained more than twenty years ago, by Mr. Cavendish, from experiments on the composition of atmospherical air, made at London and Kensington; considering, at the same time, the researches of Berthollet in Egypt and at Paris, and those of Marti in Spain, we shall find strong reasons for concluding, that the atmosphere, in all places exposed to the influence of the winds, contains very nearly the same proportions of oxygen and nitrogen: a circumstance of great importance; for, by teaching us that the different degrees of salubrity of air do not depend upon differences in the quantities of its principal constituent parts, it ought to induce us to institute researches concerning the dif-

—and consequently its relative salubrity depends on substances dissolved or suspended in it.

ferent

ferent substances capable of being dissolved or suspended in air, which are noxious to the human constitution: particularly as an accurate knowledge of their nature and properties would probably enable us, in a great measure, to guard against, or destroy, their baneful effects.

X.

Analysis of a newly discovered Mineral resembling the Hyacinth.
By Professor TROMSDORFF.*

History.

THROUGH the kindness of Prince Gallitzin, I received a new mineral substance, denominated by him *red garnet* (rather *granat*), which greatly resembled the hyacinth in respect of colour, hardness, specific gravity, &c. The native country of this new fossil is Greenland. I shall call it *compact hyacinth* (*dichter hyacinth*.)

Action of heat.

In order to investigate the nature of this fossil, it was ignited intensely for two hours, and then suffered to cool. It suffered no loss of weight, nor was its beautiful red colour in the least impaired. It was submitted to a similar action of caloric six different times, but no change was effected. It was then reduced to a powder.

Powder boiled with potash, and then fused.

A. Two hundred grains of the impalpable powder were boiled for some time in a silver crucible, with a solution of potash, containing 500 grains of dry alkali. The fluid, after having been boiled for some time upon the fossil, acquired a yellow colour, and at last became green. It was evaporated to dryness, re-dissolved in distilled water, evaporated again, and lastly ignited at as high a temperature as the silver crucible would endure.

Mafs, difficultly soluble in water, deposits a red powder.

B. The fused mass of the foregoing process, when cold, was of a dark green colour, inclining to a paler green on the sides which had been in contact with the crucible. Water seemed to have little action upon it, but after having been boiled in this fluid for a considerable time, it began to soften, and was at last dissolved. The clear solution obtained in this manner, after having been suffered to stand undisturbed, deposited a

* Translated from Crell's Chem. Annalen, 1801, Part VI, page 1.

reddish brown powder, greatly resembling the red sulphurated oxide of antimony. The supernatant fluid was perfectly transparent.

C. The whole fluid was then warmed a little, and muriatic acid added to it gradually. The powder before separated became thus soluble after this acid had been added in excess. It now acquired a dark green colour, and was perfectly transparent.

D. Having concentrated this fluid down to two ounces, no siliceous earth being deposited, it was evaporated to perfect dryness. The residue obtained was of a white colour. After being ignited, it weighed 110 grains. It was boiled again with pure potash in a silver crucible, evaporated to dryness, and fused. The fused mass was again dissolved in boiling water, muriatic acid was added in excess, and the whole evaporated to dryness. On adding some distilled water to the residue, an insoluble powder was obtained. This powder, after being washed in boiling distilled water, was dried, and then ignited. Its weight amounted to 100 grains. *It was pure siliceous earth.*

E. The fluid from which the foregoing product had been obtained, together with all the water expended in washing it, was collected together, evaporated, and mixed, whilst boiling hot, with a solution of muriate of potash. A reddish brown precipitate fell down, which, being collected upon a filtre, was washed in distilled water.

F. The precipitate, after having acquired a considerable degree of dryness on the filtre, was boiled during four hours in a concentrated solution of pure potash. The fluid was then attenuated with a considerable quantity of boiling distilled water, and transferred upon a filtre, of which the weight had been previously ascertained. The residue obtained, after a repeated ebullition with boiling distilled water, was suffered to dry, and then strongly ignited. Its weight was 32 grains. It was marked X.

G. The aqueous solution of potash, together with all the water used for washing the last obtained products, was concentrated by evaporation. On adding muriatic acid to it, a precipitate ensued; an excess of acid was therefore added, in order to re-dissolve it. The solution was then decomposed by means of carbonate of ammonia. The precipitate now ob-

Addition of muriatic acid completes the solution.

Evaporation to dryness, fusion with potash, solution and evaporation, as before, and the addition of water, separated much silica.

Precipitate, from last solution, by muriate of potash;

was dried, boiled in potash, then diluted, separated, and ignited.

The last solution was super-saturated with muriatic acid, and precipitated by carbonate of ammonia. It gave alumina.

tained was of a white colour. After being collected on a filtre, washed, and dried, its weight amounted to 56 grains. On dissolving it in sulphuric acid, and adding a minute quantity of potash, pure acidulous sulphate of alumine and potash was obtained. It was therefore pure *alumine*.

The precipitate X, ignited with potash and washed, was partly soluble in sulphuric acid.

H. The residue marked (X F) was now thoroughly dry, and of a considerable hardness. Its colour was a glittering reddish brown. It was reduced to powder, and digested in liquid ammonia. This alkali, however, after having been examined, had taken up nothing. Concentrated sulphuric acid being presented to a small quantity of it, had likewise no effect upon it. It was therefore mixed with a small quantity of dry potash, and ignited for some time; then dissolved in distilled water, and transferred upon a filtre. The residue was repeatedly washed. After being considerably dry, it was put into a glass evaporating basin, pure sulphuric acid was poured over it, diluted with a little water, and the whole carefully evaporated to dryness. On being suffered to cool, and distilled water being added, part of it became dissolved, and another part remained insoluble in the form of a brownish powder, which was collected on a filtre.

The solution contained iron.

I. This sulphuric solution (H) was of a greenish hue; its taste was astringent. Prussiate of potash threw down prussiate of iron. Tincture of galls produced a black precipitate with it. Liquid ammonia occasioned a reddish brown precipitate, which, after being washed, dried, and ignited, weighed twelve grains. It was an *oxide of iron*. It was assayed with super-saturated borate of soda by means of the blow-pipe, for investigating the presence of manganese, but no vestige of this metal could be discovered.

The sulphuric solution, H, gave (by carbonate of potash) a precipitate of zircon.

K. The product obtained by means of sulphuric acid (H), was mixed with three times its own weight of carbonate of potash, and boiled in a sufficient quantity of distilled water. A light earthy substance became separated, tinged slightly yellow, by an admixture of ferruginous matter. Being disposed to believe that this earthy substance might be zircon, it was merely collected on a filtre and washed, but not ignited. Its weight was twenty-five grains. It would, if it had been ignited, probably weighed only twenty grains. This earth was insoluble in potash, but soluble in nitric and acetic acid.

United with sulphuric acid to perfect saturation, it yielded a salt of a difficult solubility; but if this acid was added in excess, the salt was readily soluble in water. When ignited it became hard and insoluble in acids. I therefore do not hesitate to believe, that this earth was zircon, though not absolutely pure, but soiled with iron.

From these experiments it follows that 200 grains of this hyacinth-like fossil, consist of

100	grains	fossil (D)
56	—	alumine (G)
12	—	oxide of iron (F)
20	—	zircon (K)
12	—	Loss of matter during the operation,

200

XI.

Philosophical Disquisitions on the Processes of common Life.—Art of Shaving.—W. N.

THE caprice of fashion, or the modern improvements in Process of shaving personal neatness, has deprived all the nations of Europe of ing. their beards; and consequently a portion by no means inconsiderable of the small and daily conveniences of life must depend on the facility with which this appendage can be taken off. This subject is frequently treated in conversation; and I am persuaded that many individuals will be glad to know what can be stated on the whole respecting it.

The fabrication of a good razor depends on so many Instructions for choosing a good razor. circumstances and conditions, the material, the art of forging, the hardening and the temper, that the artist himself after he has exercised his utmost skill, can in the last instance, select such instruments as are eminently superior to others, by trial or actual use. I am not aware of any means of choosing a good razor out of a number. All that I can say in this respect is, that a bad razor cannot be easily brought to a fine, or even a moderate edge; for which reason I should prefer that razor which possesses the best edge, and has been most slightly touched upon the hone: that is to say, the razor which, upon looking

Character of a
very fine edge.

looking along its edge, has little or no flat part where the action of the hone has taken place, and which when drawn along the hand appears keen and smooth. I must here take notice, that the common practice of cutting the skin of the hand, in order to try a fine edge, is by no means so delicate as that of placing the edge of the razor lightly on the thick skin of the hand, so as to bear upon a length of about two inches, and then drawing it along through about one quarter of an inch, without cutting. In this manner the irregularities of edge in the finest surgeon's instruments may be plainly felt.

Art of giving a
fine edge to cut-
ting tools.

I will suppose the operator to be in possession of a good razor. He is in the next place to learn how to keep it in order. The original keenness of edge will necessarily go off by use. It can only be restored by whetting or grinding it up again. This is usually done by means of a good strap; in which little instruction is required besides what is common to every operation upon the edge of cutting instruments; namely, that they must never be sharpened but when actually dull, and that the operation of sharpening them is mischievous, if it be carried a moment beyond the time in which the full effect is produced. The act of strapping produces a smooth edge; but on account of the elasticity of the strap this edge becomes round and obtuse in the angle formed by its faces.

The strap.

Whetting upon
the hone.

A razor which has its edge too much rounded to be revived by the strap, must be sharpened upon the hone. We may consider a hone as composed of fine sand agglutinated together; the particles of which cut or rasp away the face of the tool that may be whetted upon it. This face will accordingly become filled with scratches, and the edge will be an irregular saw, with notches, so much the finer as the particles of sand were smaller, and the pressure of rubbing more light. It is found that the action of a hone is smoother, if it be left with oil upon the face when put by; an effect which probably arises from the oil becoming glutinous, and clogging the cutting points of the sand. The principal instructions for whetting a razor are, 1. That it should be drawn lightly along the stone by repeated alternate strokes with the edge foremost; and by no means backwards and forwards, unless a considerable part be required to be whetted away, which can seldom be the case unless there be a notch, or manifest irregularity

Particular in-
structions.

in

in the edge; 2. That the edge should be tried upon the hand after every two or more strokes, in order to ascertain the instant at which it shall have become very uniformly rough. This roughness, if the hone be good, and the pressure light, will constitute a very fine edge, though in general less smooth than is left by a good strap; and 3. The edge will therefore be completed by a stroke or two upon such a surface. But I will suppose that a longer continuance of whetting has been necessary, so as to produce what is called a wire, consisting of a Wire upon the edge; very thin film of steel adhering along the edge. If this should break off upon the hone during the whetting, the edge will become notched in passing over it; for which reason it must be taken off by a direct operation; namely, by passing the Taken off: edge of the razor once along the hone, holding the back rather more upright than half way between the flat and the perpendicular position, and then passing it once back again, inclining the razor the contrary way. These two strokes will detach the wire, and produce a very perfect, though very obtuse edge; which must then be brought up to the requisite keenness by two or more light strokes in the first mentioned method, taking care not to go too far. In both the processes of strapping and whetting, we have supposed the razor to be laid flat; but where a strong edge is required, the whetting, but not the strapping, may be performed with the back of the razor elevated somewhat less above the face of the hone, than half the breadth of the blade.

Our cutting instrument being now in order, there remains Enquiry how far heating a razor in water is advantageous. but one more observation before we proceed to the subject of operation; which is, that it will be found to act considerably better after immersion in hot water. While I admit the fact, I must confess that I am far from being satisfied with any of the explanations. It has been said, that the expansion by heat By improving the edge; enlarges the fine notches of the edge, and probably develops or opens others; but this effect can hardly be thought of any consequence, when it is considered that the whole expansion produced by boiling water does not exceed one part in ten thousand. Others have remarked, that as heat softens horn, Or by softening the hair; hair, and other similar substances, the hot edge may pass through a hair more easily than if cold; but here we may remark, that the heat seems too little, and its application to the hair too momentary, to be productive of so considerable a difference;

Or by cleaning the blade. difference; besides which the advantage is said, and I believe truly, to follow even if the razor be suffered to cool before it is used. Hence it should seem as if the hot water detached some particles of grease from the edge, and by that means facilitated the sliding of the cut surface of the hair upon the face of the razor.

Application and utility of soap. There is much difference of opinion as to the application and use of soap. By some it is applied cold and thick by means of a brush; others apply it hot; and others again apply hot fuds or soap-water, with much rubbing, until the alkali has rendered the skin much softer, and more disposed to be acted on by water than in its usual state. Sir John Chardin

Persian and Chinese barbers. asserts, that the great excellence of the Persian barbers consists in this practice; but I can assert on the other hand, that the Chinese, who shave with exquisite facility, use a soap box and brush with cold water. Whether the effect of the soap be to soften the surface of the hair by an incipient combination of alkali; whether it renders the stroke more easy by causing the razor to slide with facility along the surface, instead of raising up portions of skin and cutting them off, as it might otherwise do, are questions to be solved by direct experiments. Of these I know none, excepting that a mere solution of alkali is less effectual than soap, and so likewise is the mere application of oil or fat. Hence probably we may infer, that soap acts in a twofold manner; by dissolving and removing the matter of perspiration by its alkali, and lubricating by its oil. With regard to the difference of heat and cold, these effects may perhaps be forwarded, and the hair somewhat softened at the higher temperature, though the difference seems to be not very considerable.

Mechanical process or operation of shaving. Some operators place the razor flat upon the face, and others raise it to a considerable angle. It is certain that the process may be skilfully performed either way. It is a very bad practice to press the razor at all against the face; and indeed this can not be done with impunity if a drawing stroke be used. Unskilful shavers will generally injure the skin less if they lay the razor flat; but generally speaking, the closest shaving will be performed by holding the razor at the same inclination as was used in whetting it.

General Remarks. Upon the intire view of the subject it appears to me, that the only indispensable condition among the requisites before discussed,

discussed, is that the razor should be in good order: and that all the other particulars may be varied, except the mechanical process of cutting;—that the great secret of taking off the beard with facility, consists in a drawing stroke, that is to say, that the line of the motion of the razor itself should be very oblique to the line of the edge, and not at right angles to that line, as is commonly practised; so that the tool may be made to exert its action as a saw, which is much more powerful than its simple effect as a wedge. This method is indeed so very effectual, as to require great care and considerable practice before it can be adopted, in the extreme, with perfect safety; but the same efficacy which endangers the skin, renders it easy and pleasant with regard to the beard.

Essential part of manipulation.

XII.

Abstract of the Enquiries of CIT. BENEDICT-PREVOST, and some other Natural Philosophers, relative to the Motions of Odorous Substances placed upon Water. By CIT. BIOT.*

IT is a fact, which has long been known to natural philosophers, that small pieces of camphor, when placed upon water, have a very rapid rotatory motion. Volta and Brugnatelli have obtained the same results, by employing the benzoic and fuccinic acids. Citizen Benedict Prevost has extended this property to a great number of odorous substances.

Motions of camphor, &c. upon water.

But however unanimous philosophers have been in admitting the facts, they differ greatly from each other in the explanations they have given.

Citizen Prevost attributes these motions to the emanation of the odorous particles of the bodies: The experiments upon which he grounds this opinion may be found in the numbers that have been quoted. Venturi, Professor of Natural Philosophy at Modena, applies to these phenomena the explanation which Monge has given of the apparent attractions of substances floating upon the surface of water: according to him, “the water has a stronger attraction for the solid camphor,

Discussions respecting their cause.

Venturi supposes the action of water.

* Soc. Philom. 54. The experiments of Prevost, Venturi, and Carradori, alluded to in this notice, are given in the Philosophical Journal, 4to; for which see the Indexes. N.

than for the small portion of it which it has already dissolved and saturated; it ascends along the solid piece, and there forms a curvilinear inclined surface. The small portion that is dissolved and saturated descends along this surface, and, whilst it is descending, it pushes backwards, according to the laws of mechanics, the surface itself, and the solid piece that adheres to it." He thinks that we ought not to confound this effect with the repulsions which air impregnated with ether, or the exhalations of very hot camphor, exercises upon the light bodies which are made to float upon the surface of the water. In this case only he admits the presence of an elastic fluid. (*Annales de Chimie, tome 21.*)

Dr. Carradori, a kind of oil.

Dr. Carradori is of a different opinion: He explains this motion by the elective affinity of a species of oil, which, according to him, proceeds from the camphor in contact with the water. He believes that the retreat of the water, which takes place upon a wet china plate or piece of glass, when camphor or other odorous substances are placed upon it, is the effect of the elective attraction of the surface of the plate or glass for the oil which the substances emit; and, according to him, it is this oil which causes the water to recede, by substituting itself in its place. (*Annales de Chimie, tome 37.*) In support of his opinion, Dr. Carradori alledges, that camphor does not move upon the surface of the water when this is very limited. He has not been able to make small plates of metal move, as Citizen Prevost had announced, by placing a morsel of camphor upon them, and letting them float upon the surface of the water. However, I have several times repeated this experiment, and always with success; but it requires a great deal of care and extreme accuracy.

New experiments and observations of Prevost.

Citizen Prevost has replied to Dr. Carradori, in a Memoir which he has addressed to the Society, and which is intitled, *Nouvelles Expériences sur les Mouvements spontanés de diverses Substances, à l'approche ou au contacte les unes des autres.* The following are the principal facts which it contains:—

Ether acts at a distance.

A drop of ether, placed upon a small plate of tin [*fer blanc*], 15 grammes ($3\frac{1}{4}$ drachms) in weight, throws it into a lively motion, though it does not touch the surface of this liquid.

Thus ether acts upon water *at a distance*. This fact may be verified in a very simple manner. If we place a small plate of

of tin upon water, and bring the extremity of a glass tube wetted with ether within some centimetres distance of it, the plate recedes.

Small pieces of camphor, thrown upon mercury that had been well dried, were agitated there with the same motions as on the water. In order that this experiment may succeed, it is necessary that the mercury should be well cleaned or dried: the smallest particle of oil or fat spread upon its surface stops the motion. The pieces of camphor ought to be very small, the reason of which will be seen hereafter.

Very thin plates of mica, placed upon mercury, and charged with a small piece of camphor, move in the same manner as upon water.

The benzoic acid likewise assumes a rotatory motion upon mercury; but it is necessary that it be reduced into almost imperceptible fragments. An oily aureola forms itself round these fragments. Nothing similar to this is observed round camphor, not even when examined with the microscope. The metallic lustre of the mercury is not impaired by it.

It results from these facts, that the presence of water is not necessary to the motions of odorous substances.

These substances cause the water to recede upon plates of alum, of pottery [*terre à faïence*], and of gum arabic, in the same manner as upon a wet plate of porcelain. This retreat is not therefore owing to the elective attraction of the oily or odorous substance for the surface of the plate.

Finally, notwithstanding the assertion of Dr. Carradori, camphor moves in very confined vessels: Citizen Prevost has seen it agitated in capillary tubes, into which it was introduced in very minute fragments.

From these facts Citizen Prevost concludes, that the intervention of an elastic fluid is necessary to the production of these phenomena. To the facts which he has adduced, I shall subjoin the following, which appear to me to decide the question relative to the motions of camphor upon water.

If we cut a small piece of camphor, of the weight of a few grains, into the form of a cone, and approach it to the distance of four or five millimetres of a very small piece of leaf gold floating upon the surface of the water, presenting the point to it, this small piece of gold is repelled; and we may thus conduct it through the whole extent of the vase, without ever being

Camphor upon
dry mercury.

Camphor upon
mica floating on
mercury.

Benzoic acid.

Water unneces-
sary.

Inference, that
the motion is
caused by an
elastic fluid.

*Experimentum
crucis.*

being able to touch it. It is necessary that the water should be very pure, and the vessel perfectly clean. We may hold the piece of camphor with a pair of tweezers, or at the end of a glass tube; it must be cut into a conical form, as has been mentioned; a piece of a larger size and an irregular form would envelope the light body in its atmosphere, and it would not move with equal facility.

The same effects are produced, if we employ, instead of camphor, a small piece of fine sponge soaked in camphorated water, or merely a tube of glass, containing at its extremity a drop of the same solution.

Variation.

If we cover a china plate with a very thin layer of water, and approach the piece of camphor of the preceding experiment within a few millimetres of it, presenting it by the point, in such a manner that the axis of the cone is perpendicular with the surface of the layer, the water recedes under the cone, and forms a circle concentric with it. The interior part of this circle is coloured with prismatic ranges, proceeding from the prolongation of the axis, and extending from the centre towards the circumference with a very rapid motion; after some moments, the circle loses its colour from the centre to the circumference, and the iris finally disappears, whether we continue to hold the camphor over the surface of the layer or not. It is indifferent whether we hold the plate in a horizontal or vertical position: the circle is always formed in a direction perpendicular to the axis of the small cone of camphor. I observed these phenomena at the temperature of 15° of Reaumur's thermometer.

Ether on water.

Lastly, if we throw a small piece of fine sponge soaked in ether upon water, it is instantaneously thrown into motion like camphor; and a hissing noise is heard, similar to that of water during its conversion into vapour upon a hot iron. If we view the surface of the water horizontally, before a light window, we observe sparkling jets issuing from the sponge, which extend themselves in serpentine windings upon the surface of the water, to the distance of some centimetres, and there produce irides similar to those of the preceding experiment. These irides soon disappear. During this emission, the sponge has a progressive and a rotatory motion, which are evidently owing to those small jets, the impulse of which it is observed constantly to obey.

Of these three experiments, the two first shew that camphor acts upon water *at a distance*, and without contact; the third renders the manner in which its motions can be performed upon this liquid perceptible to the senses. Inferences.

It appears to me, that from a comparative view of these facts, we may deduce the following inferences as certain :

Camphor is moved upon the surface of water by the effect of the emission of the particles which compose it; an emission that becomes perceptible to our senses by the smell which it produces, and by the repulsions which it exercises against small bodies floating upon the surface of the water.

As the effect resulting from these different impulses does not pass through the centre of gravity of the piece of camphor, this centre has a progressive motion, and the body revolves round it. As the figure of the piece of camphor changes every moment, the motion of its centre of gravity is neither uniform nor rectilinear; it varies incessantly, as well as the angular velocity of rotation. As the evaporation takes place principally at the surface of the water, the rotatory motion establishes itself round the axis which is perpendicular to this surface, and which passes through the centre of gravity of the body.

As, *ceteris paribus*, the emanation of the particles of the camphor is proportionate to the extent of its surface, and as the surfaces increase only as the squares, but the masses as the cubes of corresponding dimensions, the rapidity of the motion of the camphor must be greater in proportion as its volume is smaller, and consequently its motion must be accelerated in proportion as it evaporates; which coincides with experience.

Having established these propositions, which in my opinion comprehend the true theory of the motions of camphor upon water, let us return to the second part of the work of Citizen Benedict Prevost.

It includes a great number of experiments, in which we see inodorous substances produce, upon wet glass, the same phenomena as odorous, oily, or volatile substances. Other experiments with bodies not odorous.

If we spread a small piece of fine wet linen, of any figure, upon a china plate moistened with a thin layer of water, the water appears to recede all round it, forming a multitude of jets, and exhibiting the prismatic colours*.

* These colours probably result from the decomposition of the light by the small layer of water which surrounds the piece of linen, and which becomes still thinner by the retreat of the water.

If we pour upon the piece of linen, after having spread it upon the plate, some drops of water coloured with logwood, this water runs off in coloured streaks.

The same effects take place when we use a piece of fine white paper, not sized.

We obtain them equally with all the animal and vegetable substances, with the saline liquids and solutions; whether we place them, under the same circumstances, in contact with each other, or with water.

These phenomena take place not only upon a wet china plate, but they are also observed upon surfaces of pottery, and many other substances.

From these facts, and several others analogous to them, Citizen Prevost draws the following inferences:

General results.

1. That all liquids possess the property of mutually repelling each other.

2. That all dry organised substances, which preserve any remains of organisation, exhale, whilst they imbibe water, an elastic fluid, which carries with it a part of this water, and repels that which surrounds it upon a piece of wet glass.

The first inference is contradictory to the general law of the mutual attraction of the molecules of matter.

As to the hypothesis of Citizen Prevost, concerning the formation of an elastic fluid, we shall remark, that, before he attributes phenomena to new causes, he ought to endeavour to account for them by those which are already known; to distinguish the effects produced by odorous substances from those presented by inodorous ones; and perhaps to establish in a more certain manner this repulsion of liquids by paper and linen; for this repulsion may very possibly be nothing more than an appearance produced by the flowing down of the water upon the inclined surface which these substances raise around themselves as they imbibe this liquid.

XIII.

*Case of a young Gentleman, who recovered his Sight when seven Years of Age, after having been deprived of it by Cataracts, before he was a Year old; with Remarks. By Mr. JAMES WARE, Surgeon.**

MASTER W. the son of a respectable clergyman, at Castlebury, in Somersetshire, was born in the year 1793; and, for many months, appeared to be a healthy perfect child: his eyes, in particular, were large and rather prominent. When about six months old, he began to cut his teeth; which was attended with great pain, and frequently with violent convulsive fits. About the end of his first year, a number of persons passing in procession near his father's house, accompanied with music and flags, the child was taken to see them; but, instead of looking at the procession, it was observed that, though he was evidently much pleased with the music, his eyes were never directed to the place from whence the sound came. His mother, alarmed by this discovery, was naturally led to try whether he could see silver spoons, and other glaring objects, which she held before him at different distances; and she was soon convinced, that he was unable to perceive any of them. A surgeon in the country was consulted, who, on examining the child's eyes, discovered an opacity in the pupils, which was so considerable, that he did not hesitate to pronounce there was a complete cataract in each. A description of the child's situation was then sent to me, with a request that I would point out those steps which its parents should pursue. The case was so evident, that I could not hesitate in saying, that the removal of the opaque crystalline humour, from the place it occupied behind the pupil, was the only method by which the child could obtain his sight; and, attached as I was, at that time, in all cases, to the operation of extracting the cataract, in preference to that of depressing it, I added, that I did not think he would be fit for the operation, until he was at least thirteen or fourteen years old. This advice being approved, all thoughts of assisting his sight were, for the present, relinquished. He

History of the
infancy of a
child blind with
cataracts.

* *Philos. Transf.* 1801, p. 382.

History of the
infancy of a
child blind with
cataracts.

soon discovered a great fondness for music; his memory was very retentive of the little stories that were read or recited to him; and, in every way, it became evident that he had a mind capable of receiving information. As soon as he could speak, it was also observed, that when an object was held close to his eyes, he was able to distinguish its colour, if strongly marked; but, on no occasion, did he ever notice its outline or figure. In November, 1800, his parents took him to Bristol; whither they went for the purpose of seeing the works carried on in the school for the indigent blind in that city, and in order that they might ascertain whether their son, who was then arrived to his seventh year, could be taught any thing that would be useful or amusing. Here he very quickly learnt the art of making laces. But his parents, having brought him so far from home, thought it adviseable to extend their plan, and make a visit to the metropolis, for the sake of giving me an opportunity of inspecting his eyes, and of hearing whether my opinion continued the same as that which I had written to them six years before. About a month previous to the time of their arrival, a Portuguese boy, fourteen years old, had been put under my care, who was in a similar situation; and, in this case, notwithstanding all the efforts I could use, I found it impossible to fix the eye, in order to extract the cataract, without employing a degree of force which might have been highly injurious. I therefore relinquished my intention of performing the operation in that way, and determined to make use of the couching needle; being prepared, either to depress the cataract with this instrument, if it was sufficiently solid for the purpose, or, if it was soft or fluid, (which I rather expected,) to puncture its capsule largely, so as to bring the opaque crystalline into free contact with the aqueous and vitreous humours. In order to fix the eye for this operation, I was not afraid to make use of a speculum oculi; since a pressure, which would have been highly dangerous in extracting the cataract, might be applied on the present occasion with perfect safety. Conformably to my expectation, the cataract was of a soft consistence; in consequence of which, I was not able to depress it, and contented myself with making a large aperture through the capsule, by means of which the crystalline was brought into contact

Case of a boy
who recovered
his sight by
puncture of the
capsule of the
crystalline.

contact with the other humours, a considerable part of it coming forwards, and shewing itself directly under the cornea.

This being the immediate result of the operation, it could not be expected that any improvement should be made in the sight of the patient at that time. In a few days, however, the opaque matter was wholly absorbed: the pupils became clear; and the lad recovered the sight of both his eyes.* Encouraged by the success which followed this operation, I was induced to retract the opinion which I had formerly sent to Master W.'s father, (which opinion I had given under the impression that the cataract should be extracted,) and I now proposed, that an attempt should be made to afford relief to one eye, at least, without further loss of time; this attempt, in the way above mentioned, being practicable with as much safety at his present age as at any future period; and, if it proved successful, it would give the young gentleman the benefit of vision five or six years sooner than his friends had been encouraged to expect, by my former letter on this subject. They were naturally much pleased with this alteration in my advice; and the child himself appearing to possess a great degree of fortitude, I performed the operation on the left eye, on the 29th of December last, in the presence of Mr. Chamberlayne, F. A. S. Doctor Bradley, of Baliol College, Oxford, and Mr. Platt, surgeon, in London. It is not necessary, in this place, to enter into a description of the operation. It will be sufficient to say, that the child, during its performance, neither uttered an exclamation, nor made the smallest motion, either with his head or hands. The eye was immediately bound up, and no inquiries made on that day with regard to his sight. On the 30th, I found that he had experienced a slight sickness on the preceding evening,

The same operation performed on the subject of this paper, at about eight years old.

* It should be remarked, that the sight obtained by children who are born with cataracts, is seldom so perfect as that which those recover, after the operation, who are afflicted with the disorder later in life. In consequence either of some remaining opacity in the crystalline capsule, which hinders the free admission of the rays of light, or of a greater tenuity in the remaining humours of the eye, children require, in general, a much deeper convex glass to enable them to see minute objects; and, at the same time, they are obliged to hold them much nearer their eyes than older persons.

but

but had made no complaint of pain, either in his head or eye. On the 31st, as soon as I entered his chamber, the mother, with much joy, informed me that her child could see. About an hour before my visit, he was standing near the fire, with a handkerchief tied loosely over his eyes, when he told her that under the handkerchief, which had slipped upward, he could distinguish the table by the side of which she was sitting: it was about a yard and a half from him; and he observed that it was covered with a green cloth, (which was really the case,) and that it was a little farther off than he was able to reach. No further questions were asked him at that time; as his mother was much alarmed, lest the use thus made of his eye might have been premature and injurious. Upon examination, I found that it was not more inflamed than the other eye; and the opacity in the pupil did not appear to be much diminished. Desirous, however, to ascertain whether he was able to distinguish objects, I held a letter before him, at the distance of about twelve inches, when he told me, after a short hesitation, that it was a piece of paper; that it was square, which he knew by its corners; and that it was longer in one direction than it was in the other. On being desired to point to the corners, he did it with great precision, and readily carried his finger in the line of its longest diameter. I then shewed him a small oblong band-box covered with red leather, which he said was red and square, and pointed at once to its four corners. After this, I placed before him an oval silver box, which he said had a shining appearance; and, presently afterwards, that it was round, because it had not corners. The observation, however, which appeared to me most remarkable, was that which related to a white stone mug; which he first called a white bason, but, soon after, recollecting himself, said it was a mug, because it had a handle. These experiments did not give him any pain; and they were made in the presence of his mother, and of Mr. Woodford, a clerk in his Majesty's Treasury. I held the objects at different distances from his eye, and inquired very particularly if he was sensible of any difference in their situation; which he always said he was, informing me, on every change, whether they were brought nearer to, or carried further from him. I again inquired, both of his mother and himself, whether he had ever, before this

He gained his sight,

and immediately distinguished a table and its distance;

also square paper;

a round shining box;

and a white mug.

Other experiments, by which it appeared that he knew distances and figures with much precision;

this time, distinguished by sight any sort of object; and I was assured by both that he never had, on any occasion; and that, when he wished to discover colours, which he could only do when they were very strong, he had always been obliged to hold the coloured object close to his eye, and a little on one side, to avoid the projection of the nose. No further experiments were made on that day. On the 1st of January, I found that his eye continued quite free both from pain and inflammation, and that he felt no uneasiness on the approach of light. I shewed him a table knife; which at first he called a spoon, but soon rectified the mistake, giving it the right name, and distinguishing the blade from the handle. by pointing to each as he was desired. He afterwards called a yellow pocket-book by its name, taking notice of the silver lock in the cover. I held my hand before him; which he knew, but could not at first tell the number of my fingers, nor distinguish one of them from another. I then held up his own hand, and desired him to remark the difference between his thumb and fingers; after which, he readily pointed out the distinctions in mine also. Dark-coloured and smooth objects, were more agreeable to him than those which were bright and rough. On the 3d of January, he saw, from the drawing-room window, a dancing a dancing bear; bear in the street; and distinguished a number of boys that were standing round him, noticing particularly a bundle of clothes which one of them had on his head. On the same evening, I placed him before a looking glass, and held up looking glass. his hand: after a little time he smiled, and said he saw the shadow of his hand, as well as that of his head. He could not then distinguish his features; but, on the following day, his mother having again placed him before the glass, he pointed to his eyes, nose, and mouth, and seemed much gratified with the sight.

Having thus stated the principal observations that were made by Master W. I shall now make a brief comparison Comparison of this statement with the famous instance of Cheselden. between this statement, and that which is given in the XXXVth volume of the Philosophical Transactions, of Mr. Cheselden's patient, who was supposed to be born blind, and obtained his sight when he was between thirteen and fourteen years old,

It

It should be observed, that though Master W. was six years younger than Mr. Cheselden's patient, he was remarkably intelligent, and gave the most direct and satisfactory answers to every question that was put to him. Both of them, also, if not born blind, lost their sight so very early, that, as Mr. Cheselden expresses it, "they had not any recollection of having ever seen."

My first remark is, that, contrary to the experience of Mr. Cheselden's patient, who is stated "to have been so far from making any judgment of distance, that he thought all objects touched his eyes, as what he felt did his skin." Master W. distinguished, as soon as he was able to see, a table, a yard and a half from him; and proved that he had some accuracy in his idea of distance, by saying, that it was a little further off than his hand could reach. This observation, so contrary to the account we have received of Mr. Cheselden's patient, would have surprised me much more than it did, if I had not previously, in some similar instances, had reason to suspect that children, from whom cataracts had been extracted, had a notion of distance the first moment they were enabled to see.

Other instances
differing from
Cheselden.

In the instance particularly of a young gentleman from Ireland, fourteen years old, from each of whose eyes I extracted a cataract, in the year 1794, in the presence of Dr. Hamilton, physician to the London Hospital, and who, before the operation, assured me, as did his friends, that he never had seen the figure of any object, Dr. Hamilton and myself were much astonished by the facility with which, on the first experiment, he took hold of my hand at different distances, mentioning whether it was brought nearer to, or carried further from him, and conveying his hand to mine in a circular direction, that we might be the better satisfied of the accuracy with which he did it. In this case, however, and in others of a like nature; although the patients had been certainly been blind from early infancy, I could not satisfy myself that they had not, before this period, enjoyed a sufficient degree of sight to impress the image of visible objects on their minds, and to give them ideas which could not afterwards be entirely obliterated. In the instance of Master W. however, no suspicion of this kind could occur; since, in addition to the declaration of himself and his mother, it was proved by the testimony of the surgeon

who examined his eyes in the country, that the cataracts were fully formed before he was a year old. And I beg leave to add further, that on making inquiries of two children, between seven and eight years of age, now under my care, both of whom have been blind from birth, and on whom no operation has yet been performed, I find that the knowledge they have of colours, limited as it is, is sufficient to enable them to tell whether coloured objects be brought nearer to, or carried further from them, for instance, whether they are at the distance of two inches or four inches from their eyes; nor have either of them the slightest suspicion, as is related of Mr. Cheselden's patient, that coloured objects, when held before them, touch their eyes.

But the judgment which Master W. formed of the different distances of objects, was not the only instance in which he differed from Mr. Cheselden's patient; who, we are informed, "did not know the figure of any thing, nor any one thing from another, however different in shape and magnitude;" for Master W. knew and described a letter, not only as white, but also as square, because it had corners; and an oval silver box, not only as shining, but also as round, because it had not corners: he likewise knew, and called by its name, a white stone mug, on the first day he obtained his sight, distinguishing it from a basin, because it had a handle. These experiments were made in the presence of two respectable persons, as well as myself; and they were several times repeated, to convince us that we could not be mistaken in them. I mention the circumstance, however, with much diffidence, being aware that the observations not only differ from those that are related of Mr. Cheselden's patient, but appear, on the first statement, to oppose a principle in optics, which I believe is commonly and justly admitted, that the senses of sight and feeling have no other connection than that which is formed by experience; and, therefore, that the ideas derived from feeling can have no power to direct the judgment, with respect either to the distance or form of visible objects. It should be recollected, however, that persons who have cataracts in their eyes, are not, in strictness of speech, blind, though they are deprived of all useful sight. The instances I have adduced prove, that the knowledge they have of colours is sufficient to give them some idea of distance, even in their darkest

Remarks on
figures, &c.

darkest state. When, therefore, their sight is cleared by the removal of the opaque crystalline, which intercepted the light, and the colour of objects is thereby made to appear stronger, will it be difficult or unphilosophical, to conceive that their ideas of distance will be strengthened, and so far extended as to give them a knowledge, even of the outline and figure of those objects with the colour of which they were previously acquainted?

Chirurgical observations and remarks.

The case which I have here related appears to deserve notice, not only on account of the observations that were made by the patient on recovering his sight, but also on account of the hint which it affords to surgeons, relative both to the mode in which the cataract may best be removed, when children are born with this disorder, and the time when it is most proper to perform the operation.

In what cases depression of the cataract may be preferable to extraction.

The Baron de Wenzel, in his ingenious Treatise on the Cataract, with great force of reasoning, deduced from the long and successful experience of his father and himself, recommends, in all cases of this disorder, without making any exceptions, the operation of extraction, in preference to that of depression; and I believe it is now generally acknowledged by medical men, that in the more common cases, his decision as to the mode of operating is perfectly well founded. The Baron admits that the operation is not so certain a cure in children as it is in persons of a more advanced age; both on account of their untractableness, and because, in them, the opacity of the crystalline is not unfrequently accompanied with an opacity in the capsule that contains it. On these accounts, when children are born with this disorder, he advises to postpone the operation, until they are old enough to be made sensible of the loss they sustain by the want of sight, and have firmness of mind to submit patiently to the means that are requisite in order to obtain it. Influenced by this opinion of the Baron, and believing the operation of extraction to be so much superior to that of depression, that the latter ought not, on any occasion, to have the preference, I have given advice, in the cases of a considerable number of children who were born with this disorder, to postpone every attempt to relieve them, until they were thirteen or fourteen years old. Prior to this time, it did not appear to me that children could be depended upon to submit, with due steadiness, to the repeated introduction of instruments,

instruments, which is sometimes necessary in extracting the cataract; and, even at this age, the eyes of some are so small, and in such a constant rolling motion, that it is almost impossible properly to accomplish the operation. The Portuguese lad, whose case has been related, afforded an instance of this kind; and I consider it as a fortunate circumstance that it came under my notice, since, in some degree, it may be said to have obliged me to examine, more attentively than I had before done, the advantages and disadvantages of the operation of depression; which operation, being more easy to perform than that of extraction, has certainly this advantage in the cases of children, (to which alone I here advert,) that it may be performed with equal safety when they are only seven years of age, as it may at any subsequent period of their lives.

It is well known that the late Mr. Pott, who published his remarks on the cataract in the year 1775, was a strenuous advocate for this operation; and, though he appears to me to have much under-rated the advantages of extraction, it must be allowed that he makes many just and highly pertinent observations on the use of the couching needle, in those cases where the cataract is soft, or fluid. Mr. Pott considered this as a very common state of the disorder; and does not make any distinction between the cataract when it attacks grown persons, and when children are born with it. In the former case, experience inclines me to believe, that the cataract is very rarely fluid, or even soft; whereas, in the latter, I have always found it, agreeable to the observation of the Baron de Wenzel, in one or other of these states. Although, therefore, in the case of grown persons, the operation of extraction appears to me to have very great advantages over that of depression, yet, in the case of children, I can readily accede to almost the whole that Mr. Pott advances in favour of depression. If the couching needle be passed in the way in which it is usually introduced to depress the cataract, and thereby a large aperture be made in the capsule of the crystalline, (which operation may be performed with perfect safety, and with very little pain to the patient, whilst the eye is fixed with a speculum oculi,) the opaque crystalline, being thus brought into contact with the aqueous and vitreous humours, will, in a shorter or longer space of time, according to its degree of soft-

Pott favoured the practice of depression.

Reasons in support of Pott.

ness, be absorbed; and, if there be not an opacity in the capsule, as well as in the crystalline, the pupil will become clear, and the patient will acquire a very useful sight. If, in addition to the opacity of the crystalline, the capsule be also opaque, and, in consequence of this, the operation do not prove successful, the eye will nevertheless be perfectly uninjured, and it will be as fit, at a subsequent period, to have the capsule extracted, as it would have been if no attempt of the above kind had been previously made.

From the foregoing observations, I flatter myself I shall be justified in deducing the following inferences.

Those born blind from cataracts distinguish colours, and approach or recede; though very imperfectly;

First, When children are born blind, in consequence of having cataracts in their eyes, they are never so totally deprived of sight as not to be able to distinguish colours; and, though they cannot see the figure of an object, nor even its colour, unless it be placed within a very short distance, they nevertheless can tell whether, when within this distance, it be brought nearer to, or carried farther from them.

which greatly helps their judgment on acquiring the power of vision.

Secondly, In consequence of this power, whilst in a state of comparative blindness, children who have their cataracts removed, are enabled, immediately on the acquisition of sight, to form some judgment of the distance, and even of the outline, of those strongly defined objects with the colour of which they were previously acquainted.

Such children may in general be cured in the way of depression.

Thirdly, When children have been born with cataracts, the crystalline humour has generally, if not always, been found either in a soft or fluid state. If, therefore, it be not accompanied with an opacity, either in the anterior or posterior portion of the capsule, and this capsule be largely punctured with the couching needle, introduced in the way in which this instrument is usually employed to depress the cataract, there is reason to expect that the opaque matter will, sooner or later, be absorbed, the pupil become clear, and the sight be restored.

This process does not prevent subsequent extraction.

Fourthly, If, in addition to the opacity of the crystalline humour, its capsule be also opaque, either in its anterior or posterior portion, or in both, (which circumstance cannot be ascertained before the operation,) and, in consequence of this, the operation above mentioned should not prove successful, it will not preclude the performance of extraction afterwards, if this be thought adviseable.

Fifthly,

Fifthly, The operation above mentioned being much more easy to perform than that of extraction, and it being possible to fix the eye with perfect safety during its performance, by means of a speculum oculi, it may be undertaken at a much earlier age than the latter operation; and a chance may of course be given to the patient, of receiving instruction, without that loss of time which has usually been thought unavoidable, when children are born with this disorder.

As the depression may be made earlier in life, the subject will gain earlier instruction.

IT ought to be mentioned, that about a month after the above mentioned operation on Master W.'s left eye, I performed a similar operation on the right eye of the same young gentleman. Although he behaved with great firmness on the first occasion, it was not without considerable difficulty that his head was kept steady on the second. The operation, however, gave him very little pain, and no inflammation followed; but the opacity afterwards was not diminished; and he did not acquire any additional sight from this eye. There was an evident mark in that part of the capsule where the couching needle pierced it; though the aperture was too small to admit a sufficient number of rays of light to give an idea of objects. It seems probable that the want of success, in this instance, was owing to an opacity in the capsule, which was incapable of being absorbed. The eye, however, is as fit to have the aperture in the capsule enlarged, or a portion of it removed, when the patient is of a proper age, as if no operation had been previously performed.

The second operation was performed a month after the first. It did not restore the eye.

I beg leave also to add, that since these pages were put together, a case has come under my care, which seems to afford a confirmation of the remarks that have been offered respecting the state of the cataract in children, and the effects that are likely to be produced by the operation of puncturing the capsule that contains it. A young lady, eighteen years old, was put under my care, who had been blind from an early part of her infancy. She had a cataract completely formed in both eyes; and in each there were three or four opaque spots, more white than the rest, which seemed to lie on the surface of the opaque crystalline. I punctured the capsule of each with a couching needle, according to the proposition in the

Narrative of a case which adds force to the preceding inductions.

preceding pages, in the presence of Mr. Scott, surgeon, in St. Alban's-street. The operation gave her no pain; and, in the course of a few days, the opacity was evidently diminished, particularly in the right eye, the patient discovering the colour of objects more plainly than before, but being still unable to distinguish their figure. At the end of a month, finding no further improvement in her vision, it appeared to me most probable that the remaining opacity was situated in the capsules. I therefore determined to extract either a part or the whole of each of them. The incisions of the cornea were made in the usual manner; after which, I punctured the anterior parts of both the capsules with the sharp end of a gold curette. The punctures became immediately transparent, without affording an issue to the liquor Meibomii, or any other humour. From hence it seems evident, that nothing was contained within the capsules, or, in other words, that the crystalline humours were absorbed; and it appears to me highly probable, that their absorption had been occasioned by the previous operation of puncturing their capsules with the couching needle. I dilated the new punctures with the end of the curette; and afterwards, being still afraid that the apertures in the capsules might not be large enough to admit a sufficient number of the rays of light, I removed a portion of each of them with a small forceps. This was accomplished in the left eye, without occasioning the discharge of any part of the vitreous humour; and, in the right, the quantity of this humour that came away was very small. In the course of a week, the inflammation that followed the operation was nearly removed; a large portion of both pupils was quite clear; and the young lady distinguished objects with quickness and precision.

all these blank spaces; that is to say, his table comprehends the right ascension and declination of the middle of each of these spaces.

The changeable stars are comprehended in a second table; they are thirty one in number. There are not more than twelve, the periods of which are known; but there are several others which are diminished so as to disappear. By following them attentively, we may determine the time which elapses between two successive disappearances; and this is a species of observation which Citizen Lalande proposes to the curiosity of those who, having only indifferent instruments, wish nevertheless to be useful to astronomical science.

A third table presents thirty-three stars of a red colour. Since the year 1756, Mayer had remarked this colour in the 19th of Pisces, which he designates in his registers of observations by the epithet of *Rubicunda*, as he finds by the copy, which Prof. Lichtenberg has sent of all the observations made by Mayer, on the day when he observed Herschel's planet. Mitchell and Baillie suppose, that the colours of the stars may depend either on the different intensity of their fire, or the degree of their inflammation, and that the red colour may indicate a fire which is in a diminishing state. According to this hypothesis, it would be a matter of importance to examine the changes of colour which take place in the stars. Be that as it may, these variations, if they exist, are certainly extremely slow; for the different shades of colour which are remarked at the present day in Antares, Arcturus, Aldebaran, Sirius, and the Lyre, existed in the age of Ptolemy.

Extract of a memoir on the degree of magnetism which blades of steel of different thickness acquire, and on some results relative to the needles of the compass, by CITIZEN COULOMB.—Almost all the magnetic phenomena may be reduced to calculation, if we suppose two magnetic fluids to exist in the steel, in each of which the molecules repel each other in the inverse ratio of the square of the distances, and attract the particles of the other fluid in the same ratio. This law has been proved by C. Coulomb in the Memoires of the Academy of Sciences for 1786, according to experiments which appear to be decisive.

When the steel is in its natural state, and has not been touched with the load stone, the two fluids are neutralized by each other; that is to say, they keep themselves in equilibrio,
and

and exert no action, since one of the fluids attracts a magnetic particle with the same force as that with which the other repels it.

When the fluids are separated, they tend to unite and neutralize each other; and they would actually unite, were there not a coercive force that opposed this union. This force may be either the adhesion of the molecules of the fluid to the steel, or the friction which they undergo in passing from one point to another.

The author has proved, *Memoires de l'Academie des Sciences pour 1787*, page 491, that whether we suppose the two fluids to be separated and carried each to one extremity of the blade, or that they are only displaced in each particle of the steel, the result of the calculation will be the same. He has proved at the same time, that this latter supposition is the only one which can be made to agree with the facts.

In the present memoir the author endeavours to determine the magnetic state of several blades united successively one above the other; or, which amounts to the same thing, he endeavours to determine the powers of different blades relative to their thickness.

New Planet.

New planet between Mars and Jupiter.

Mr. Piazzi, of the University of Palermo, discovered on the 1st of January, 1801, a star which appears to be a new planet. By observations repeated for several succeeding days he concluded, that its orbit is not likely to be parabolic, but agrees best with the hypothesis of a circle, the radius of which appears to be 2,6362 of the earth's mean distance, and consequently its position will be between Mars and Jupiter. Its bulk appears to be about $1\frac{1}{3}$ that of the earth. He has assigned to it the name of *Ceres Ferdinandia*, being the names of the ancient divinity of Sicily, and of its present sovereign the founder of the Observatory at Palermo. An account has been lately presented to the Royal Society. At present I give the following particulars from a paper in German,

SCIENTIFIC NEWS.

NATIONAL INSTITUTE OF FRANCE.

Extract of the Report of the Transactions of the Class of Mathematical and Physical Sciences, during the last Trimestre of the Year 9. French National Institute.

Mathematical Part. By CITIZEN DELAMBRE.

Memoir on the Equilibrium of Arches. By CIT. BOSSUT. Bossut on arches.

AS the key stones of which an arch is composed, support themselves by mutual equilibration, and remain suspended without the aid of any support beneath, their whole force directing itself against the buttresses; in order to ensure the duration of an arch, it is not sufficient that all its key-stones be in equilibrio; but it is necessary that its supports at the ends should oppose a resistance adequate to the force which it exerts in order to overthrow or break them in pieces.

The enquiry respecting the means proper for preventing their being overthrown, constitutes what is termed the problem of the lateral pressure of arches. Several geometricians of the last century had already occupied themselves with this subject, but they had intirely neglected to inquire into the means of preventing these supports from being crushed.

C. Bossut undertook, in the year 1770, to treat the question in the most general manner, as well for simple arches as domes. He has investigated whatever relates to the figure and the lateral pressure of vaults. His memoirs have been printed in the volumes of the Academy of Sciences for the years 1774 and 1776.

After many new observations and various experiments, which may be of the greatest practical utility, C. Bossut has resumed the subject of his two memoirs. He has new modelled them by simplifying his calculations in several places, and has made a number of additions relative both to theory and practice; so that the whole, in its present state, constitutes a work that may be considered as original.

Comets.—C. Messier has read an account of the comet Comet of July 12, 1801. which he discovered on the 23d of Messidor last, about half an

hour

hour after eleven in the evening: its light was very feeble; in 41 minutes of time it moved 24 min. 40 sec. of right ascension direct, and 6 min. 38 sec. north declination decreasing. The same comet was seen on the same day, and almost at the same instant by Citizens Mechain and Bouvard; the latter of whom had even observed it at the meridian at 11^h 57^m 49 sec. true time. The right ascension was 111 deg. 15 min. and the north declination 69 deg. 30 min.

C. Pons observed it on the same day at Marfeilles, and he had even perceived it on the preceding day; but the clouds did not at that time permit him to ascertain, by regular observations, whether it was a comet, or merely a nubecula.

Summer solstice,
1801.

Observation of the summer solstice of the year 9.—Citizen Duc-la-Chapelle, associate, has communicated to us the result of the observations, made by him at Montauban, in order to determine the solstitial height of the sun, and the obliquity of the ecliptic.

From an average of nine days observations, he finds 23 deg. 28 min. 9 sec. for the apparent obliquity, taking 15 min. 48 deg. for the semi-diameter of the sun, and 44 deg. 0 min. 52 sec. for the latitude of his observatory.

Lalande on the
fixed stars.

Remarks concerning the 50,000 stars, of which observations have been published by Citizen Jerom Lalande.—C. Lalande, in the preface to his *Histoire Céleste*, had noticed the existence of many blank spaces in the heavens, many changeable stars, and many red stars. He now resumes these subjects in a more circumstantial manner, in a memoir accompanied with tables.

By blank spaces, (*d'espèces vuides*) Citizen Lalande understands in this memoir, those spaces in which no stars of the 9th degree of magnitude are to be perceived. These are the smallest that can easily be distinguished with an achromatic telescope of 67 millimeters aperture, in which light is admitted to illuminate the wires.

It is not to be doubted that by excluding all light from surrounding objects, and employing the most powerful telescopes, the blanks properly so called would be found to be considerably diminished; perhaps even there is not a single spot in the firmament, towards which we could direct a telescope, without perceiving a great number of stars, though below the ninth degree of magnitude, and consequently too small to be of any use in astronomy. C. Lalande gives the catalogue of

A Treatise on Astronomy, in which the Elements of the Science are deduced in a natural Order, from the Appearances of the Heavens, to an Observer on the Earth; demonstrated on Mathematical Principles, and explained by an Application to the various Phenomena. By Olinthus Gregory, Teacher of Mathematics, Cambridge. 8vo. 522 Pages, with Nine Plates. London, fold by Kearsley. Gregory's
Astronomy.

Elements of Chemistry. Materia Medica, and Pharmacy. By J. Murray, Lecturer on Chemistry, Edinburgh printed. Sold by Longman and Rees, London. Murray's
Chemistry.

Observations on the Winds and Monsoons, illustrated with a Chart, and accompanied with Notes, Geographical and Meteorological. By James Capper, formerly Colonel, and Comptroller-General of the Army and Fortification Accounts on the Coast of Coromandel. Quarto. 234 Pages. Debrett. Capper on Winds
and Monsoons.

Accounts of the three last mentioned Works will appear in our next,

Über den Werth und Nutzen der Runkelbruben.—On the Value and Use of the White Beet-Root. By J. G. W. 1801. 29 Pages. Glogau. J. G. W. on
Beet-fugar.

This pamphlet contains minute instructions for preparing fugar, syrup, coffee, brandy, rum, and arrack, from the white beet-root (*beta cicla*). In order to obtain fugar from the beet-root, the author directs the roots to be cut into slices, to express the juice, to boil it down to a strong consistence, and to suffer it to crystallize. The residue, from which the juice has been expressed, may be used for obtaining brandy, but it is better to boil the beet-root to reduce it to a pulp, suffer it to ferment, and then submit it to distillation. In order to deprive the spirit of the peculiar flavour of the root, it must be rectified over charcoal powder. Eighty pounds of beet-root yielded eight quarts of brandy. To obtain rum, the roots are likewise boiled, the juice expressed, and mixed with charcoal powder, evaporated to one-third, then suffered to ferment, and afterwards distilled with the charcoal powder. In order to obtain arrack, the juice is to be evaporated to one-half, then suffered to ferment, and distilled.

Recherches

Des-Mortiers on Prussian Blue. *Recherches sur la Décoloration spontanée du Bleu de Prusse, &c.—Inquiries into the spontaneous Loss of Colour in Prussian Blue, and the spontaneous Return of its Colour; read at a private meeting of the Free Society of Sciences, Literature, and Arts, at Paris, by U. R. T. le Bowyer-des-Mortiers, Member of the Society.* Paris. 8vo. 32 p. 1801.

A person had made for sale a pretty considerable quantity of blue paint, consisting of a mixture of white lead, Prussian blue, and nut oil. To prevent its drying he covered it with water some inches deep, and set it by till wanted. After a certain time, a person coming to buy some of the paint, he was much surpris'd to find it all white, except at the surface, where the colour was well preserved. He was preparing to add fresh Prussian blue to the paint, when, on grinding it in the open air, without any addition, he saw the colour return of itself, and on continuing this operation, it became as deep a blue as at first. He then covered it with oil, supposing it would keep better than under water; but he was disappointed, for the colour disappeared a second time throughout the whole mass.

The Society of Physic and the Arts at Nantes, to whom some of this paint was carried in its white state, spread part of it on writing paper, part on wood, and part on the wall of a window. After a longer or shorter time, the colour of the paint re-appeared with all its lustre, but that on the paper was most slowly restored.

What is the cause of this phenomena? Is it the oil, which, by undergoing a change, destroys the colour of the Prussian blue? Is it the air altogether, or one of its constituent principles, or any other substance mixed or dissolved in it, that restores the colour? These are the questions which the author endeavours to answer, in publishing the different interesting experiments he has made on the subject, from which he deduces the following conclusions.

1. The loss of colour in the paint is not owing to the decomposition of the oil, but to a change of surfaces, occasioned by the subsiding of the mass, and by the extinction of the luminous globules in the minute laminæ and in the pores of the colouring substance. 2. Neither the air altogether, nor one of its constituent principles, nor any thing it contains, is ne-

OBSERVATIONS.

1801	Med. Time. h m	Geo. Long. °	Geo. Lat. °	Right As. ° ' "	Decl. ° ' "
June 20	13. 4	101. 45	3. 26 N	103. 6 40	26 22 10 N
July 17	1. 43	113. 3	4. 6	115. 38 50	25 32 35
Aug. 12	10. 54	124. 21	4. 51	127. 56 5	23 54 10
Sept. 7	16. 19	135. 23	5. 41	139. 44 30	21 38 25
12	22. 0	137. 40	5. 52	142. 2 20	21 8 10
18	3. 0	139. 50	6. 3	144. 17 0	20 37 0
23	8. 0	141. 58	6. 15	146. 29 20	20 6 25
28	13. 0	144. 5	6. 27	148. 40 0	19 35 0
Oct. 3	17. 41	146. 9	6. 40	150. 47 0	19 4 40
8	22. 0	148. 12	6. 53	152. 50 50	18 33 40
14	3. 0	150. 12	7. 8	154. 55 30	18 4 40
19	7. 0	152. 11	7. 22	156. 56 20	17 34 20
24	11. 0	154. 8	7. 37	158. 55 0	17 5 10
29	14. 45	156. 3	7. 53	160. 51 30	16 37 0
Nov. 3	18. 0	157. 56	8. 9	162. 45 40	16 9 0
8	22. 0	159. 48	8. 26	164. 38 50	15 41 50

S ° ' "

Place of Ascending Node	- - - - -	2. 20. 58. 30
Inclination of the Orbit	- - - - -	10. 47. 0
Place of the Aphelion	- - - - -	2. 8. 59. 37
Time of passage through the Aphelion Jan. 1.		
1801	- - - - -	1,3328
Excentricity	- - - - -	0,0364
Log. of the half great Axis	- - - - -	0,4106986
Time of the Siderial period	- - - - -	4,13 years.

ACCOUNT OF BOOKS OF SCIENCE.

Philosophical Transactions of the Royal Society of London, for the Year 1801. Part the Second. Quarto, 214 Pages, with Eighteen Plates. London, fold by Elmsly.

THIS Part contains :—1. A Historical and Anatomical Description of a doubtful Amphibious Animal of Germany, called by Laurenti, Proteus Anguinus. By Charles Schreibers, M. D. of Vienna.—2. Observations tending to investigate the Nature of the Sun, in order to find the Causes or Symptoms of

Royal Society of London.

Royal Society
of London.

of its variable Emission of Light and Heat; with Remarks on the Use that may possibly be drawn from Solar Observations. By William Herschel, LL. D. F. R. S.—3. Observations on the Structure and Mode of Growth of the Grinding Teeth of the Wild Boar, and Animal Incognitum. By Everard Home, Esq. F. R. S.—4. Account of some Experiments on the Ascent of the Sap in Trees. By Thomas Andrew Knight, Esq.—5. Additional Observations tending to investigate the Symptoms of the variable Emission of the Light and Heat of the Sun; with Trials to set aside Darkening Glasses by transmitting the Solar Rays through Liquids; and a few Remarks to remove Objections that might be made against some of the Arguments contained in the former Paper. By William Herschel, LL. D. F. R. S.—6. On an improved Reflecting Circle. By Joseph de Mendoza Rios, Esq. F. R. S.—7. Observations and Experiments upon Dr. James's Powder; with a Method of preparing, in the Humid Way, a similar Substance. By Richard Chenevix, Esq. F. R. S. M. R. I. A.—8. Case of a young Gentleman, who recovered his Sight when seven Years of Age, after having been deprived of it by Cataracts, before he was a Year old; with Remarks, By Mr. James Ware, Surgeon.—9. An Account of some Galvanic Combinations, formed by the Arrangement of single Metallic Plates and Fluids, analogous to the new Galvanic Apparatus of Mr. Volta. By Mr. Humphry Davy, Lecturer on Chemistry in the Royal Institution.—10. A Continuation of the Experiments and Observations on the Light which is spontaneously emitted from various Bodies; with some Experiments and Observations on Solar Light, when imbibed by Canton's Phosphorus. By Nathaniel Hulme, M. D. F. R. S. & A. S.—11. Experiments on the Chemical Production and Agency of Electricity. By William Hyde Wollaston, M. D. F. R. S.—12. Farther Observations on the Effects which take place from the Destruction of the Membrana Tympani of the Ear; with an Account of an Operation for the Removal of a particular Species of Deafness. By Mr. Astley Cooper.

cessary to restore the colour; for it revives *in vacuo* as well as in the open air. 3. Caloric, without the contact of light, is detrimental to the return of the colour, instead of contributing to it, and even destroys it. 4. Finally, the intestine motion of its parts, however exerted, is sufficient to re-produce the colour more or less speedily, according as there are more or less light and motion.

Essai sur le Calorique.—*An Essay on Caloric; or, Inquiries into the Physical and Chemical Causes of the Phenomena exhibited by Bodies subjected to the Action of the Igneous Fluid, with new Applications of them respecting the Theory of Respiration, Animal Heat, the Origin of Volcanic Fires, &c.; to which are added, An Essay on the Anomalies of Chemical Affinities; Experiments and Observations on Bell-metal; and a Description of the famous Alum Mine of Souvignaco, in Istria, and of the Processes employed for extracting and purifying the native Alum:* by Joseph-Mary Socquet, M. D. formerly Physician to the Army. Paris. 8vo. 473 p. Price 5fr. 1801. Socquet on Caloric.

Natural philosophers are yet far from being agreed on the nature of caloric, and the phenomena ascribed to it. In this volume Dr. S. has published eight essays on the subject.

The 1st treats of caloric considered in its chemical and physical relations to other bodies, whence may be deduced the principal phenomena they exhibit when subjected to the action of this fluid; as their capacity for caloric, their dilatation, fusion, gassification, tendency to equilibrium of temperature, &c.

In the 2d the author turns his attention to the cause of the perpetual production of heat by the friction of bodies, and of the consequences which Count Rumford deduced from his own experiments on the subject,

In the 3d he treats of the conducting power of liquids for caloric.

The 4th contains new views on respiration, and the cause of the production of heat in warm-blooded animals.

The subject of the 5th is the nature of volcanic fires, the causes of which the author deems independent of any local combustion, produced by the decomposition of water or of any other oxide, or by submarine or subterranean currents of air.

The

Socquet on Caloric.

The 6th contains seven cases of chemical affinity:—1. Pre-disposing affinities, as they are called: 2. The decomposition of sulphate of iron by caustic ammoniac: 3. The decomposition of muriate of soda by sulphate of magnesia, or of the zero of Reaumur: 4. The reciprocal decomposition of alkaline phosphates by carbon, and of alkaline carbonates by phosphorus: 5. The decomposition of water in the solution of iron by diluted sulphuric acid; and the decomposition of the acid, not of the water, in dissolving quicksilver by the same menstruum: 5. The precipitation of free sulphuric acid, by mixing the two sulphates of mercury and ammoniac: 7. Whence comes it, that those portions of solvents which are last fixed in their bases easily separate from them, while the first portions, though of the same nature, and fixed in the same substances, adhere to them much more forcibly?

The author's residence in Italy having given him an opportunity of travelling over almost all the provinces of the quondam state of Venice, and some other countries dependent on Austria, he visited a great number of productive and interesting manufactories. The extensive alum mine of Souvignaco, in Istria, of which there was no description extant, probably on account of its very remote and wild situation, and perhaps because it is of no ancient date, afforded him some curious particulars respecting the disposition and nature of the ore, the simple, ingenious, and partly new processes followed there, and the theory of the various phenomena they exhibit. These are the subjects of the 7th essay.

In the 8th Dr. S. gives a summary of his experiments on the extraction of pure copper from bell-metal, the results of which had already been published in several Italian journals; together with some other operations in the large way, which he had executed at Venice on different objects of art, particularly the separation of soda from common salt*. The corrections, or rather additions, proposed by the Chev. Napoleone to the processes already known for decomposing the different kinds of bronze, were too interesting, for our author to omit making them known at large; particularly as he had an opportunity of convincing himself of their utility, by repeating the experiments of that learned mineralogist, at Turin.

* See *Opuscoli scelti sulle Scienze e sulle Arti: da Carlo Amoreti: tom. xx.* Milan.

Atlas de la Partie Meridionale de l'Europe, &c.—*An Atlas of the Southern Part of Europe, constructed to the Meridian of Paris, and consisting of forty Sheets, which, being on the same Scale, may be pasted together, so as to form the most comprehensive Map that has ever yet been published of the different States it includes: by C. Chanlaire, Member of the Lyceum, and one of the Authors of the National Atlas of France.* Paris. 1801. Chanlaire's
Atlas of the
South of Eu-
rope.

This map is remarkable for the accuracy of its details, and may supply the place of a great many maps of single countries.

Mémoires d'Agriculture, &c.—*Memoirs of Agriculture, and Rural and Domestic Economy, published by the Agricultural Society of the department of the Seine, and printed by order of the Prefect of the department.* Vol. I. Paris. 8vo. 447 p. 1 plate. Price 4fr. Memoirs of the
Agricultural So-
ciety of the de-
partment of the
Seine.

An account of this work will appear in our next.

BOOKS OF SCIENCE,

Imported by Deboffe, of Gerrard-Street, Soho.

ANNUAIRE de la Republique Francoise, par le Bureau des Longitudes, pour l'An ix. Par. An. viii. in 18. br. 1s. 3d. Books of science
imported.

Carnot de la Correlation des Figures de Geometrie. Par. 1801. 8vo. Fig. br. 7s.

Clairault Elém. d'Algebre. 6th Edit. 2 Vol. 8vo. Par. 1801. Fig. br. 14s.

Essais sur la Ligne Droite et les Courbes du Second Degré par Francois. 8vo. Par. 1801. 4s.

Gallitzin Recueil de Noms, &c. appropriés en Mineralogie suivi d'un Tableau Mythologique. Brunswick, 1801. 4to. br. 12s.

Haüy Traité de Mineralogie publié par le Conseil des Mines. Par. 1801. 4 Vol. avec Atlas. 2l. 2s.

Memoires

Books of science imported. Memoires de l'Institut National, 3e livraison An. ix. 3 Vol. 4to. Fig. cart. 3l. 3s.

Memoires des Societes savantes de la Republique Francoise, par Prony, Parmentier, Duhamel, &c. 4to. pour l'Année. 1l. 16s.

Monge, Traite Elementaire de Statistique Par. An. ix. 8vo. Fig. br. 6s.

Olivarius le Nord, Litteraire, Physique, Politique et Morale Ouvrage periodique publié tous les 3 Mois, les 16 Premiers Cahiers. 8vo. br. 2l.

O'Reily Essai sur le Blanchiment. Par. 1801. 8vo. Fig. br. 7s. 6d.

Pallas Observations faites dans un Voyage enterpris dans les Gouvernemens Meridionaux de l'Empire de Russie, pendant les Années 1793 & 1794. Leipz. 1801. Tom. 2. 4to. Atlas. 4l. 14s. 6d.

Philosophie de Kaunt, ou Principes fondamentaux de la Philosophie transcendente, par Villiers. Metz. 801. 8vo. br. 6s.

Plans & Dessins tirés de la Belle Architecture, ou Representations d'Edifices executés ou projetés, en 115 Planches par Stieglitz. Londr. 1801. Fol. Cart. 9l. 9s.

Principes d'Economie Politique: Ouvrage couronné par l'Institut Nationale, par Canard. Par. 1801. 3s.

Traite Elementaire de Physique par Libes, Professeur aux Ecoles Centrales de Paris. Par. 1801. 3 Vol. 8vo. Fig. br. 1l. 4s.

Voyage dans l'Inde et au Bengal, pendant les Années 1789 et 1790, par Grandpre. Par. 1801. 2 Vol. 8vo. Fig. br. 14s.

Voyage en Syrie, No. 20. Proof Plates, 2l. 12s. 6d.—Not Proof, 1l. 15s.

A

JOURNAL

OF

NATURAL PHILOSOPHY, CHEMISTRY,

AND

THE ARTS.

FEBRUARY, 1802.

ARTICLE I.

On the supposed Currents in hot Liquids. By THOMAS THOMSON, M. D. Lecturer on Chemistry in Edinburgh.
(From the Author.)

THERE is perhaps no subject of enquiry in which we are more liable to deceive ourselves than in the investigation of the internal motions of the particles of bodies. As these particles are individually too minute to come under the cognisance of our senses, their motions must of course be invisible, and can only be inferred from certain visible changes which we consider as the consequences, or at least as the constant attendants of these motions. But unfortunately it seldom happens that the phenomena, from which we draw our inferences, are of such a nature as to entitle us to affirm that they can only originate from one single cause, and from no other. They may be assigned in general to a variety of causes; and much patient industry, with no small share of address, is necessary to develope the true one; and even all the precautions which we can employ do not always prevent us from falling into error. The phenomenon, which forms the subject of this paper, affords a very striking illustration of the great caution with which we ought to draw conclusions, even when the inference seems at first sight to follow irresistibly from the phenomena.

Great difficulty of investigating the internal motions of the particles of bodies.

Concise narrative of Count Rumford's experiments to render currents observable in fluids; by floating grains of amber.

Count Rumford was first led to suspect that fluids are non-conductors of caloric, by the appearance of certain opaque particles moving upwards and downwards in them, while they were cooling in a window, exposed to the direct light of the sun. He very naturally concluded that these motions were occasioned by the currents of the liquid moving in the same direction with the opaque bodies. Hence he inferred that every individual particle of the liquid was cooled only by depositing its caloric at the surface or the sides of the vessel, and that therefore these particles were incapable of giving out heat to each other. The contrivance by which he rendered these motions visible to the naked eye was in the highest degree simple and ingenious. He mixed amber, in the state of small grains, with an alkaline solution, diluted with water till its specific gravity was exactly the same with that of amber. The amber, of course, remained suspended in any part of the liquid; but as soon as heat was applied, it began to move upwards and downwards, exhibiting the currents to the eye of the spectator.

The motions of these grains have always been thought demonstrative of the existence of currents;

Nothing can appear a more satisfactory proof of the existence of currents in the liquid than the motion of the amber; so convincing is it indeed, that hitherto no person, as far as I know, has ever suspected the possibility of this motion originating from any other cause. I have repeated the experiment frequently, and even exhibited it to others; and though the motions did not exactly correspond with those indicated by Count Rumford, they never failed to produce the fullest conviction of the existence of the very currents which that philosopher had indicated. Yet the fact is, that the motion of the amber is not occasioned by currents in the liquid, and very often exists when there are really no currents at all.* This assertion will probably, at first sight, appear rather extraordinary; but the proofs on which it is founded leave no room for doubt.

but they are not moved by currents.

Difficulties attending the supposition of currents as rapid as the motions of the amber.

When we reflect upon these supposed currents, several circumstances cannot fail to present themselves, which do not admit of an easy explanation. The motion of the amber is pretty rapid, yet the mere difference in the specific gravity of

* I neglect the trifling currents occasioned by the amber itself, which it would be extremely difficult to appreciate.

the hot and cold particles of the liquid, the causes assigned by Count Rumford for the existence of the supposed currents, is capable of producing only a motion so very slow, as scarcely to be visible. But what is still more puzzling, if possible, is the total discordance between these rapid currents and the slow rate at which the liquid cools. If the water actually moved with the rapidity indicated by the amber, and if it parted with the tenth part of the caloric necessary to produce that rapidity, the whole of the liquid would cool down to the temperature of the atmosphere almost in an instant: whereas, in fact, several hours are always necessary to produce that effect.

These apparent anomalies suggested the possibility of the motion of the amber being occasioned by some other cause than currents in the liquid, and made it necessary to examine the matter with more attention. The following experiments occurred to me as the simplest method of determining whether the supposed currents existed or not. Into the glass vessel A, Pl. VIII. Fig. 2, I poured water, tinged blue with the juice of red cabbage, till it stood at the height m . Then by means of a slip of cork swimming on the surface of the blue infusion, and a funnel terminating in a long capillary tube, I succeeded (after several unsuccessful attempts) in filling the vessel with water to the height n , without mixing it with the blue infusion. Thus I had two liquids in the vessel A, both very nearly of the same specific gravity, the undermost of a blue colour, the uppermost colourless, and the plane m , which separated them, pretty well defined. There were several opaque bodies floating through the blue infusion, which answered the purpose of the amber.

My intention was to apply heat to the bottom of the vessel A, which I knew would produce the supposed currents, that is to say, would set the floating bodies in motion. Now if these floating bodies were really put in motion by currents, it is evident that part of the blue infusion must accompany them. But this would become evident whenever they passed the plane m , and entered into the colourless medium: for in that case they would be accompanied by a blue current, which would be visible to the eye. Whereas if the floating bodies were in motion while the water continued at rest, they would pass the plane m , and move through the colourless water

Experiment 1.
Upon water, tinged blue, was poured clear water with such care as not to mix them. Several opaque bodies floated in these fluids.

It was expected, when heat should be applied, either that the lower fluid would ascend in a blue current and carry up the opaque bodies, or that these bodies would ascend alone through both fluids, and consequently without the mediation of any current.

without carrying any of the blue infusion along with them.

On trial the bodies rose and circulated through both fluids without any indication of a current;

I accordingly lighted a lamp, and put it at some distance below the vessel A, placing the vessel exactly between my eye and the window. The lamp was at such a distance, that it was some time before the floating bodies began to move. At last, however, they ascended gradually, passed the plane *m*, and entered the colourless medium, *without being accompanied by any of the blue infusion*. They then descended again in the usual manner; and this alternate motion continued for some time, without occasioning a mixture of the two liquids. Thus I obtained a full demonstration that the motion of the floating bodies was not occasioned by currents in the liquid, but was altogether independent of any such currents. Every time that a floating body passed the line *m*, the blue infusion was agitated, and its surface raised into a wave. By the constant repetition of this undulation, the plane *m* became ill-defined, and gradually ascended higher and higher, till at last almost the whole of the water acquired a blue tinge. But it was almost ten minutes before this happened, and the motion of the floating particles, which continued without interruption during the whole time, was altogether unequivocal.

and ten minutes elapsed before the motion had carried the blue tinge through the upper fluid.
Experiment 2: An alkaline solution, with floating grains of amber, was boiled, and left to cool to 150°. The upper part, to the depth of half an inch, was then tinged. No change whatever took place in the tinged fluid, though the amber circulated through the whole fluid, while cooling.

It was still necessary to repeat the experiment with the amber itself, in order to ascertain whether or not its motions were of the same nature with that of the floating bodies in the last experiment. I therefore filled the glass vessel A, to the height *n*, with an alkaline solution containing amber floating in it. I then heated the solution boiling hot by holding the vessel over a fire, and even allowed it to boil for some time. The vessel was then suspended in a room, where the temperature of the air was 50°, and the alkaline solution allowed to cool down to 150°.* I then tinged the surface of the solution by means of a drop or two of the infusion of red cabbage, so as to form a coloured stratum of about half an inch thick at the surface of the solution.† The cooling continued without interruption, and the liquid reached the temperature of the air without the smallest alteration in the coloured stratum, or any mixture of it with the colourless

* By previous trials I had ascertained that at a higher temperature the experiment does not succeed.

† The colour thus communicated is yellow when only a little cabbage juice is used; too much gives a green colour.

solution

solution below. Yet, during the first part of the cooling, the amber was moving upwards and downwards; particles of it often come to the very surface, and descended again to the bottom. This experiment proves decisively that the motion of the amber is not occasioned by currents, and that there were, in reality, no currents at all during the whole time of cooling from 150° to 50°.

Having thus proved that the motion of the amber is not owing to currents, but that it forces its way through the liquid; it becomes a point of some consequence to ascertain, if possible, the cause of this motion. Perhaps the following observations will contribute to throw some light on the subject.

1. When an alkaline solution containing amber, as exactly as possible of the same specific gravity with itself, is heated in a glass vessel nearly to the boiling temperature, and then suspended in the air to cool, the whole of the amber sinks to the bottom. Hence we see that, though the amber is of the same specific gravity with the cold solution, it is specifically heavier than the same solution when hot. Consequently amber does not expand so much when heated as the alkaline solution does.

2. But the amber does not remain long at the bottom; the grains of it gradually rise one after another, and ascend to the surface, but with very different velocities, some rapidly, others slowly. After touching the surface they always fall down again to the bottom. These alternate motions continue for some time; but the number of ascending and descending particles gradually diminishes, and at last they all settle at the bottom. It is no uncommon thing for two particles of amber, one ascending, the other descending, to meet together in some part of the solution. In that case they sometimes exchange motions; the one that was formerly ascending now sinking to the bottom, while the descending particle returns again to the surface. If the experiment be made with a transparent solution, and in a good light, every ascending particle of amber will be observed to have an air bubble attached to it which buoys it up. This bubble separates at the surface of the liquid, and the amber, thus deprived of its buoy, tumbles down again to the bottom. When two particles meet, the air bubble sometimes passes from the one to

Why does the amber thus move through the fluid?

Observation 1. Amber expands less by boiling heat than the alkaline solution.

Obs. 2. Each particle of amber is carried up by an adherent air-bubble, which it loses at the surface, and then falls again.

the other, which occasions their reciprocal change of motion. These air bubbles are of different sizes, hence the different velocities of the pieces of amber.

Obs. 3. The amber acquires a higher temperature by boiling than the solution itself, and consequently it generates steam.

3. If the alkaline solution be made to boil for a few minutes in a glass vessel, and then suspended immediately in the air to cool, bubbles of steam continue for some time to detach themselves in great abundance from the pieces of amber, and occasion a very brisk motion in these pieces. Hence we see that the amber acquires a temperature higher than 212° , and that it gradually parts with this excess of caloric to the surrounding liquid.

Obs. 4. Irregular motions after the steam has ceased; followed by subsidence.

4. After all extrication of steam ceases, the amber continues to move rapidly upwards and downwards in a very irregular manner. The rapidity of these motions gradually diminishes, and when the solution has cooled down to about 140° (the air being 50°) the amber settles at the bottom. * These motions are too rapid to be occasioned by the cooling of the liquid, yet they are certainly connected with its high temperature. I would have supposed that they indicated the currents into which the liquid was thrown by boiling, as they are extremely similar to what takes place when the liquid is agitated violently, were it not that they last much longer, and that they always stop when the difference between the temperature of the liquid and of the air is about 90° .

Obs. 5. Ascent of the amber; whence it is inferred that it cools less rapidly than the fluid.

5. After the amber settles at the bottom, the cooling goes on without any thing remarkable till the liquid reaches the temperature of about 100° (the air being at 50°). At that temperature some of the amber may be observed suspended just above the bottom of the vessel; and, as the cooling advances, the amber gradually rises higher and higher. No motion can indeed be perceived, but if the situation of any individual particle be observed at intervals, it will appear evident that it has changed its place, and ascended nearer the

* This experiment requires that the amber be in the state of a pretty fine sand, otherwise it settles at the bottom at the very first. But even then the currents may be distinguished by the naked eye, if the glass vessel be transparent. This fact is curious, and can only be explained by supposing a greater interval than usual between the currents and the rest of the water, or by supposing their specific gravity to be different.

surface.

surface. By the time the liquid has reached the temperature of the air, some of the amber may be observed floating on its surface, some of it a little below the surface, and, in short, in almost every part of the liquid. After this the liquid may be left at rest as long as you please; but the amber does not change its situation, unless some very considerable change takes place in the temperature of the surrounding air. Here we see that the water cools down more rapidly than the amber; so that at a certain period the amber becomes specifically lighter than the water, and therefore rises; extremely slowly indeed, because the difference between the specific gravity of the two bodies is small. I supposed at first that the rise of the amber was owing to the descent of the superior strata of the liquid, which, of course, would have forced up the strata in which the amber was; but I was mistaken. For when the surface of the solution was tinged yellow, the yellow stratum remained neatly defined, and without changing its place during the whole of the process.

This ascent is not caused by a current.

Annotation. Atwood, in his Treatise on Motion, Sect. V. Prop. 12, demonstrates that a sphere of evanescent weight will ascend in any dense fluid uniformly with a velocity equal to what it would have acquired by falling in free space through four third parts of its diameter. This is the greatest possible velocity of ascent of a sphere in any fluid. It may seem absurd to attempt a calculation, one of the assumptions of which shall be the diameter of an integrant particle; but if we take any gross quantity (such, for example, as the millionth part of an inch), for the diameter of a particle of water at its utmost expansion by heat, and deduce its velocity of ascent (which in that case could scarce amount to the two hundredth part of an inch in a minute), we shall find little reason to admit that ascending currents can be produced by the mere enlargement of the particles heated only by contact with the containing vessel. This, however, must necessarily be supposed if the particles be non-conductors with regard to each other.

Ascent of a sphere in a fluid;

Motion of the particles of water by mere expansion must be extremely slow.

The excellent paper before us directs our attention to the mechanical cause of that circulation, which undoubtedly takes place during the communication of heat to fluids from below,

Circulation of fluids by change of temperature.

and is the principal reason of their much speedier augmentation of temperature in this way. The extrication and ascent of elastic fluid appears, in most and probably in all cases, to precede, and at last to produce circulation in dense fluids. And on this object there is still an extensive field for research, concerning the manner in which heat is communicated through fluids. But it would be by no means fair to anticipate, by crude conjecture, those explanations which we may expect to obtain from the experimental research of others. W. N.

II.

A Memoir on the Art of making Gun-Flints. By CITIZEN DOLOMIEU.*

No information to be found in books on the art of making gun-flints.

THE art of making gun-flints, which has been long practised in a small territory situated between the two neighbouring departments of Loir-Cher and L'Indre, is directed to an object, of which the whole value, commercially considered, is of little magnitude; but which is of the first necessity in the use of fire-arms of every description. The author of the present Memoir was desirous of acquiring some information respecting it, but found that it was to no purpose that he extended his researches to a variety of works on mineralogy and different subjects of the arts and trade. The Encyclopédie is silent on this process; excepting in the repetition of a ridiculous prejudice concerning the re-production of flints in places whence they were excavated. From the precision with which the figure is given to these stones, it has even been suspected that they could hardly be afforded at the low price they bear, if in its first state the material were not even soft. But the art is extremely simple in its process; it requires a very small number of instruments, a short apprenticeship, and a very moderate degree of skill to form, by mere fracture, figures so accurate, faces so smooth, outlines so direct, and angles so neat, that the stone seems as if cut on the wheel of the lapidary. Five or six small blows of the hammer, during one minute of time, are sufficient to produce

* From *Memoires de l'Institute Nationale*, III, 348, in part abridged.

the same perfection of figure as would require more than an hour's labour, if the sections were to be made by grinding against harder substances, or friction with emery. Less than a farthing will pay for a gun-flint from the hand of the workman, but fifty times that sum would be insufficient for its purchase if it were fashioned by any other process.

The author regularly proceeds to examine first the material best adapted to the use in question, the instruments employed, and the manipulation by which the stones are fashioned.

With regard to the material, every kind of stone, capable of producing strong sparks when struck against steel, may be used as a gun-flint, if it can but be fashioned by simple and cheap means. But even in this case there are some motives of preference; such, for example, as that the scintillation should be produced with the least possible blow, and with no considerable wear or abration of the steel. These reasons of prædilection are in favour of the siliceous stones, when compared with those which are called quartzose. But the *filex* or flint, properly so called, possesses not only this kind of superiority, but another property, that it is more particularly susceptible of being broken into fragments or plates, which require but very little labour to give them the requisite form and dimensions.

Among the *filex* it is therefore that the fabrication of gun-flints have found the material truly proper for the exercise of the art. And among the numerous varieties of this species of stone, there is only one which can be advantageously fashioned by the hammer alone. The agates and chalcedonies, which are also applied to this use, are brought to the requisite form by the mill of the lapidary. The makers of gun-flints in France denominate the stone of which they make use *caillou*, and they themselves are called *caillouteurs*. The word *caillou* is used by them to denote the best and most serviceable kind of flint; whereas, in the other parts of France, it denotes a pebble; that is to say, a rounded stone, whatever may be its nature.

The flint of the workmen in gun-flints belongs to that species of *filex* which naturalists have denominated *filex ignarius*, or the *feuerstein* of the Germans, &c. But every coarse flint is not proper for this use. In fact, the best stone is far from being plentiful in nature. Many countries

tries are entirely deprived of them; and the author thinks that it may probably be affirmed, that France almost alone possesses that variety of filex which can be easily broken into gun-flints, since he cannot suppose that the art of making them could remain a mystery to other nations who do not practice it, though they make great use of the flints: the art itself being so simple, that they must have speedily acquired it, if they have possessed the material.

Denomination. In his description of the variety of filex here alluded to, he gives it the name of filex pyromachus to express its use, which he prefers to the term filex sclopetarius, as being more musical.

The external characters are :

External characters. The filex pyromachus, when dug up, is always covered with a white external crust, one or two lines or more in thickness, of an earthy, chalky appearance, and loose texture, much softer and less heavy than the filex it envelopes. The external form of the masses of good stones of this description has a somewhat convex surface, approaching to the globular figure. Those of irregular forms are full of imperfections. The best stones are not very large. They seldom exceed the weight of twenty pounds, and they ought not to be of less weight than one or two pounds. Their aspect, when broken, is greasy, shining a little, and the grain is so fine, that it is imperceptible. The colour of these good stones may vary from the yellow colour of honey to a blackish brown. In this respect it is to be noted that the value of a stone does not depend on its colour, but on the uniformity of the tint, which becomes less intense when the stone is reduced into thin splinters. The flints of the two departments first mentioned are yellowish. Those of the chalk hills on the banks of the Seine are blackish brown. Both the one and the other, when pulverised, are perfectly white. The filex pyromachus ought to possess an uniform semi-transparence, of a greasy aspect, to such a degree, as to admit letters to be distinguished through a piece of the stone of one-fiftieth of an inch thick, laid close upon the paper. Its fracture must be smooth and equal throughout, and very slightly conchoidal; that is to say, convex or concave. This kind of fracture is one of the most essential properties upon which the faculty of being divided into gun-flints depends.

The

The workmen select the stones proper for their use by their external character. They compare that part of the masses of flint, which is uniformly semi-transparent and coloured, to the inner skin of bacon, which they call *couenne*. They say that one flint has more or less *couenne*, or is more or less fat than another. They assert that the upper part of a flint is always of a better quality than the lower. Flints are considered as imperfect or intractable when naturally deprived of any of the external characters before indicated, or when injured by long exposure to the air. Most of the masses are subject to have whitish opaque spots and a kind of knots where the material is harder than in the other part of the stone. When these accidents are too abundant, the stone is rejected as useless.

The physical characters are as follow:—Specific gravity of the white flint pyromachus from the banks of the Cher proved to be 26041; that of the blackish kind from the chalk hills of Laroche Guion was 25954. In this respect it does not differ essentially from the other varieties of flint, of which the specific gravities are usually between 26100 and 25900. Hardness a little superior to that of jasper, but inferior to that of agate and chalcidony. It is nearly the same as that of the other common flints. Brittleness. It is more brittle than most other siliceous stones. The light coloured is more so than the darker; these last being rather more scintillant, and and wear away the hammer more quickly. When two pieces of the flint pyromachus are strongly rubbed together, they emit the peculiar well known smell of siliceous stones, but in this variety it is more strong than in any other.

Chemical characters. Action of the air.

The flint pyromachus, deprived of its natural coating, and exposed for a long time to the changes of the atmosphere, acquires a second white friable coating, consisting of the flint reduced to powder; and even its internal part loses its greasy appearance and semi-transparency, so as to become whitish. In this case the specific gravity, which was 25954, becomes 25754, consequently it has lost 200 parts of the weight it possessed at first.

The flint pyromachus is sometimes too moist when taken out of the quarry. It requires to be dried; but if by too long exposure to the air or the wind it loses a certain portion of its humidity.

Selection of the best flints from their greasy aspect.

Physical characters. Specific gravity, hardness, brittleness, &c.

Chemical characters. Action of air.

It contains moisture.

humidity which is often very perceptible when it is recent, it can then no longer be broken into gun-flints, as its fracture is less easy. The workmen carefully reject all those which have lost this favorable degree of moisture. Perhaps they might be restored by keeping them in a damp place, or covering them with earth, and by these means at least they might succeed in preserving those intended to be worked up in winter.

Effect of heat.
Oxidation.

When the fragments are thrown upon a red hot plate of iron it flies and cracks, and becomes opaque. When projected in powder upon nitre in fusion, it gives a few sparks with slight inflammation and detonation.

When calcined in a test it loses one 250th part of its weight, increases in bulk, becomes extremely white, and so brittle as to be almost friable. In this state it resembles the finest porcelain biscuit.

Distillation.

When distilled in a retort by strong heat it affords a little carbonic acid gas, and a quantity of water amounting to 200 parts of the weight before indicated as its specific gravity; but gives no sign of the combustibile matter which in the preceding experiment caused the nitre to detonate.

The flint is an
imperfect hydrophanes.

This water, which appears essential to all the flints, and may be called their radical water, is the cause of their transparency. Exposure to air by drying them renders them opaque; so that they may be considered as imperfect hydrophanes; for they do not again absorb, but with difficulty the water necessary to their transparence. This water also contributes to the connection of their integrant particles, whence their fracture becomes more equal, and is harsh when they have lost it. These flints when recently dug up even afford an aqueous vapour when struck, and the face of the fracture is humid, and as it were moist.

Chemical analysis.

Chemical analysis; fusion with potash; precipitation of the flex, &c.

Citizen Vauquelin examined 100 parts of flex pyromachus of a brownish colour, and uniformly semi-transparent from the hills of La Roche Guion. He mixed the mass with 400 grains of very pure potash, which by fusion in a silver crucible afforded a compound, which after cooling was diffused in water, and then super-saturated with muriatic acid. The very clear solution was evaporated to dryness, re-dissolved in water, and the flex thus saturated, and left upon the filter after being well washed,

washed, dried and ignited, weighed 97 grains. Ammonia was afterwards added to the clear liquid, where it produced a slight yellowish white precipitate, which after being well washed and dried weighed one grain, and was found to be a mixture of alumine and oxide of iron. The fluid separated from this small portion of iron and alumine, gave no other precipitate on the addition of carbonate of potash, and the waters used in the washing left no residue when they were evaporated to dryness. The result therefore was filix = 97 grains, alumine and oxide of iron = 1, loss = 2. The author considers it to be a very remarkable fact, that the filix pyromachus should contain only filix and water, the alumine and iron being too small in quantity to be considered as essential to its composition, or to influence its habitudes. Quartz also, from the analyses which have been made, appears to contain only filix; yet the more he examines the two substances, the more he finds reason to suppose them essentially different from each other; since the one refuses to assume the crystalline form, and the other assumes it and becomes clear, even in contact with the flint itself. The one appears to be incapable of admitting water into its composition, while the other constantly contains it until it begins to be decomposed. He offers a query, whether the difference may not consist in the small portion of combustible or fatty matter, which caused the detonation with nitre, or whether the quartz may not, like alum, acquire its property of crystallizing from the addition of some other substance. This question, as he remarks, must be resolved by future experimental enquiries.

Difference between filix and quartz.

The analysis of the whitish spots afforded filix 98 grains, oxide of iron 1, carbonate of lime 2. That of the absolutely opaque parts gave five parts more of carbonate of lime; and lastly, the analysis of the white coating naturally enveloping the masses, afforded 86 parts of filix, 1 oxide of iron, 10 carbonate of lime, and 3 loss. Those analyses which afforded no alumine, shew that this earth is not essential to the filix, and the absence of lime in the first analysis shews that it was an accidental ingredient in the latter.

Mineralogical situation. In France in the environs of St. Aignan, situated in the department of Loir-Cher, and in that of L'Indre, and the departments which occupy the vallies of Siene and Marne, are principally the places where this stone

Mineralogical situation.

stone

stone is found. It exists in the chalky calcareous stones, its chinks more or less fine and solid, and in marles. They form horizontal strata, by the manner in which the large and small masses are placed beside each other. Nevertheless, as the blocks of flint do not accurately touch each other, there is no solution of continuity between the upper and lower masses of chalk.

Out of twenty beds of flint lying one above the other, at a distance of twenty feet or less, there will frequently be no more than one, and very seldom two, which afford good stones of this description; but in the bed which affords them, almost all the blocks have a greasy appearance, and in the other strata scarcely any of this description will be found. Accordingly the good strata are followed by subterraneous excavations, frequently at considerable expence, while the others are neglected.

On the banks of the Cher the flints are explored in a plain, by digging shafts to the depth of 40 or 50 feet, from whence horizontal galleries are carried into the only good stratum which is known.

On the banks of the Seine in the hills of La Roche Guion, the cliffs of chalk present steep precipices, where the strata of flint are exposed; and one of these strata, which contains good stones for gun-flints, is about six toises from the upper surface of the great mass of chalk.

Instruments.

Description of
tools or instru-
ments.

The mace.

The instruments used for fashioning the gun-flints are four in number:

1. A small piece of iron or mace, with a square head, *Platé V. Fig. 1.* the weight of which does not exceed two pounds, or perhaps a pound and a half, with a handle seven or eight inches long. This instrument is not made of steel, because if it were too hard, its stroke might shatter the flint, instead of breaking it by a clear fracture.

The hammer.

2. A hammer with two points, in which the position of the points is of consequence as to the nature of the stroke, *Fig. 2.* This hammer, which must be of good steel well hardened, and does not weigh more than sixteen ounces; some do not exceed ten. It is fixed on a handle seven inches long, which passes through it in such a manner, that the points of the hammer are nearer the hand of the workman, than the center of gravity.

gravity of the mass. The form and size of the hammers of different workmen vary a little, but this disposition of the points is common to them all, and is of consequence to the force and certainty of the blow.

3. A little instrument named Roulette (roller) which represents a solid wheel, or segment of a cylinder, two inches and one third in diameter. Its weight does not exceed twelve ounces, it is made of steel not hardened, and is fixed on a small handle six inches long, which passes through a square hole in its center. Roulette.

4. A chissel bevelled on both sides, seven or eight inches long, and two inches wide, of steel not hardened; it is set on the block of wood which serves as a work bench, out of which it rises to the height of four or five inches. To these four instruments we may add a file, for the purpose of restoring the edge of the chissel from time to time. Chissel.

The process:

After selecting a good mass of flint, the whole operation may be divided into four manipulations. Manipulations.

1. To break the block. The workman being seated on the ground, places the flint on his left thigh, and strikes it gently with the larger hammer, Fig. 1. to divide it into portions according to its size, that is to say, of about a pound and a half each, with broad surfaces nearly flat. He is careful not to crack or produce shakes in the flint by striking it too hard. Break the block.

2. To cleave the flint, or break it into scales. The principal operation of this art is to cleave the flint well: that is to say, to separate from it pieces of the length, thickness, and figure, adapted to be afterwards fashioned into gun-flints; and in this part the greatest degree of address, and certainty of manipulation are required. The stone has no particular direction in which it can be most easily broken. The course of its fracture depends entirely upon the choice of the workman. In this process he holds a piece of flint in his left hand, not supported, and strikes with the hammer, Fig. 2. on the broad faces produced by the first fracture, in such a manner as to chip off the white coating of the stone in small scales, and to lay bare the flint in the manner represented, Fig. 5.; after which he continues to strike off other similar portions of the pure flint. These pieces are nearly an inch and a half wide, two inches and a half long, and one sixth of an inch thick in the middle. Cleave or scale the flint.
No particular direction of fracture.

They

Figure of the
scales.

They are slightly convex within, and consequently leave a space somewhat concave, terminating longitudinally in two lines, somewhat projecting, and nearly strait. The prominent edges produced by the fracture of the first scales, must afterwards constitute nearly the middle of the subsequent pieces; and those pieces only, in which they are found, can be used to form gun-flints.

In this manner the operator continues to cleave, or scale the stone in different directions, until the natural defects of the mass render it impossible to make the fractures required, or until the piece is reduced too much to receive the small blows which separate the pieces.

3. To fashion the flint.

Fashion or form
the flint.

The gun-flint, Fig. 7. may be distinguished into five parts, namely, 1. the edge, or bevel part, which strikes the hammer or steel. This is two or three twelfths of an inch in width. If it were broader it would be too liable to break, and if more obtuse it would not afford a brisk fire. 2dly. The side edges, which are always somewhat irregular. 3dly. The back edge, most remote from the hammer where the stone possesses its intire thickness. 4thly. The under surface, which is smooth and slightly convex. And 5thly. The upper face, which is slightly concave, and receives the action of the upper claw of the cock, in which it is fixed for service.

Operation.

In order to fashion the stone, those scales or chips are selected, which have at least one longitudinal prominent angle. One of the two edges is fixed on to form the striking edge; after which the two sides of the stone which are to form the side edges, and that which is to form the hinder edge are successively placed with the convex surface upon the edge of the chissel, which is supported with the fore-finger of the left hand, at the same time that a small blow or two is given above the point of support with the Roulette, Fig. 3. by which the stone breaks exactly along the edge of the chissel, as if it had been cut. In this manner the sides and posterior edge of the stone are made.

Complete the
edge

4. The stone being thus reduced to its proper figure, the finishing operation consists in completing its edge in a strait line. For this purpose the stone is turned, and the under flat part of the edge is placed on the chissel, in which situation it is completed by five or six small strokes with the Roulette.

The

The whole operation of fashioning a gun-flint is performed in less than one minute.

A good workman can prepare a thousand good chips or scales in a day, if his flints be of good quality, and he can also fashion five hundred gun-flints in a day; consequently in three days he will cleave and finish a thousand gun-flints without further assistance.

The rate of working. One thousand flints in three days.

This manufacture leaves a great quantity of refuse; that is to say, about three fourths of the whole stone: For there are not more than half the scales which prove to be well figured, and nearly half the mass in the best flints is incapable of being chipped out: so that it seldom happens that the largest piece will afford more than fifty gun-flints. The larger pieces of refuse are sold for the culinary purpose of striking a light.

Much refuse or waste.

The gun-flints when completed are sorted out, and sold at different prices, according to their degrees of perfection, from 4 to 6 decimes (or pence) the hundred. They are classed into fine flints and common flints; and according to their application into flints for pistols, fowling pieces, and muskets.

The fabrication and commerce of gun-flints in France is in some measure confined to three communes of the department of Loir-et-Cher, and one department of the Indre, as was before mentioned, namely, the commune of Noyers, 2,400 metres east north-east of St. Aignan; the commune of Couffy at 5,600 metres, and that of Meunes at one miriameter east south-east, and in the latter department, the commune of Lye 9 kilometers to the south-west of St. Aignan. The inhabitants of these communes employed in this species of industry are about 800, and they have excavated great part of the plain they inhabit.

Local situation of the manufactories in France.

A single workman named Stephen Buffet, who emigrated from the commune of Meunes to the banks of the Seine, where he has carried on this art for about thirty years by himself, was the person from whom Dolomieu obtained the present instructions. There are a few other places in France where this art is practised, but in none to the extent of the places before mentioned. The author has not met with this manufactory in any other countries, except in the territory of Vicenza, and one of the cantons of Sicily. He remarks that it may be carried on elsewhere, though probably overlooked by travellers, on account of its apparent insignificance. I believe it is practised at Purfleet, in the county of Kent, and in various other parts of England.

Elsewhere practised.

III.

Letter from Dr. BEDDOES on Prognostics of the Weather, the Effects of the Nitrous Oxide, and other Objects.

To Mr. NICHOLSON.

SIR,

Clifton, Jan. 9, 1802.

Probability that the ensuing spring and summer may prove cold.

SINCE the late fall of snow, I have been asked by several people, how I would now apply the principle, stated in a letter, inserted in one of your former Numbers *. My answer was, that it induced me to suspect a corresponding great fall in the N. and N. E. regions. If this be the fact, and if no unknown calorific process take place between us and the equator, it would furnish an unfavourable prognostic with regard to the weather of the ensuing spring and summer.

How the weather is to be foreknown.

We can, I suspect, only attain a degree of prescience concerning the seasons, by comparing the order of the most obvious meteorological events. This, you know, was the way in which the first improvements were made in astronomy. In order to gain another point of comparison, I beg leave diffidently to propose a conjecture, respecting the duration of different falls of snow. The duration, I suppose, will bear some proportion to the quantity on the ground. For example, *if an inch of snow fall, when the thermometer has been within the twelve preceding hours above 32° it will either lie a much shorter time than if six inches fall, so as to lie under the same condition.* Perhaps the duration will generally be at least equal to the squares of the depths.

Conjecture.

Atmospheric currents of different temperature.

You will suppose that I found my conjecture upon some sort of reasoning. I deduced falls both of snow and rain, after Dr. Hutton, from the mixture of airs, unequally heated. I consider snow falling and lying in quantity, as the sign of a great current of air from the polar regions, particularly when the wind has blown for some time from the opposite points;

* *Philos. Journal, Quarto V. 131. The principle is that, If there be an unusual fall of snow in the countries on the N. and N. E. our summer, ceteris paribus, will be cold and wet.*

that

that is, when a large body of air, at above 32°, has gone to the northward of these islands. If the snow lie to any depth, I imagine this to be a sign of the preponderance of an under-current from the same quarter, which will generally produce a frost of some continuance, as well as snow in the first instance. Where a S. or S. W. wind prevails, the snow will change into rain, and not lie to any depth.

I abridge this precarious speculation, (which it would be *Query* easy to extend into a pamphlet) and suppress many explanations, in order merely to propose, as a query, *Whether a snow, like that which now covers the earth, be not always actually the forerunner of a frost of some days, and generally of some weeks, continuance?*

During the present week we had the curious phenomenon of a thaw for (I believe) near 48 hours, with the wind at N. E. which no doubt arose from a considerable upper current from the contrary quarter, at no great elevation. But the quantity of snow, already on the ground, made me venture repeatedly to say, that the weather would not soon change to a compleat thaw. On the intermediate thaw.

In a short time I intend to put to press a report of the operations at the pneumatic institution here. The nitrous oxide has justified the expectation, originally formed of its powers in palsy, and also as a *restorative*, if I may employ this abused word, to certain constitutions uniformly broken down, and has proved an admirable *soother* of the sufferings of old age. We (I speak of myself and other persons, concerned at the institution) have frequently witnessed in new patients the temporary restitution of the voluntary power over a perfectly paralytic limb during the act of inhalation. This power has become permanent afterwards in some instances, but not always, though perhaps not from want of efficacy in the air. It has also been discovered here, that oxygen gas, long inhaled, affects the growth and the internal parts, especially the bones, in a very extraordinary manner. The effect on the bones I had anticipated, and the altered growth, seems a natural consequence. Some accurate drawings by Mr. King will serve to exhibit these effects. Medical effects of the nitrous oxide, &c.

We shall have to report also some considerable improvements in medicine from the use of new, or little known remedies. Will you allow me to mention, that I should be glad to engage with an active and ardent young enquirer, who has already some readiness in common chemical processes. His employment would be in researches, connected with medicine and physiology. If such a person, resident in London, should be induced by this notice to inquire, he might obtain some previous satisfactory information from Mr. Davy at the Royal Institution.

Wishing your improved Journal the support it merits,

I am, SIR,

Respectfully your's,

THOMAS BEDDOES.

IV.

On the Quantity of Nutriment to be obtained from various Kinds of Bones, and the best Method of extracting it, by Professor PROUST.

Proust on improving the subsistence of the soldier.

MR. PROUST, professor of chemistry at Madrid, has published a work, intitled an Inquiry into the Means of Improving the Subsistence of the Soldier. The following is a summary of what it contains of most importance, and of general utility.

Jelly from bones.

It has long been known, that a very agreeable and nutritious food might be procured from bones: a food particularly recommended as a restorative under the name of hartshorn jelly, which is in fact procured by boiling shavings of bones, the common hartshorn shavings of the shops. All that is wanting, is a cheap and easy mode of procuring this jelly in sufficient quantity from a substance now commonly thrown away; for bones after they come out of the pot are as good for the purpose, and nearly as productive, as fresh bones. The shavings are too dear. Papin's digester, which has been employed, is a machine too expensive for the poor, too dangerous for common use, and apt to give the jelly a burned taste.

To

To obviate all these objections, nothing more is necessary; Mode of pro-
 than to reduce the bones to powder; which may be very rea- curing it.
 dily done between a pair of toothed iron cylinders, as in the
 ammoniac works. The bones thus comminuted are to be
 boiled in eight or ten times their weight of water for the space
 of four hours, or till about half the water is wasted, when the
 liquor will be found on cooling of a due gelatinous consistence.
 A vessel with a tight cover should be used, that the water may
 acquire as much heat as possible; and it should not be of cop-
 per, as this metal is easily dissolved by animal mucilage.

It is to be observed, that bones from different parts afford Proportions of
 different proportions of jelly, by which of course the quantity jelly in different
 of water should be regulated. According to the experiments bones.
 of Mr. P. five pounds of the middle part of the bone of a leg
 of beef will afford nine pints of jelly; the same quantity of the
 bone of the joint, fifteen pints; of the ribs and spine, eleven
 quarts; of the rump and edge bone, thirteen quarts. Five
 pounds of mutton bones of every sort together give nineteen
 pints of jelly. Pig's bones yield a little more. To Mr. P's
 taste, the jelly from pig's bones was the most agreeable of all:
 that from mutton had the distinguishing flavour of the meat.
 Of the jellies from beef bones that from the ribs was most
 pleasing, both to the sight and palate, that from the leg and
 joints least.

In warm weather the liquor must be boiled down somewhat
 more, if it be intended to assume the same gelatinous consist-
 ence when cold; as the same quantity of bone, that would
 afford a quart of jelly in winter, will not yield above a pint
 and a half, or a pint and a quarter in summer, but then it
 contains proportionally more nourishment.

If this jelly be boiled till it acquires a consistence a little Portable jelly
 thicker than a syrup, then poured out into plates, and when
 cold cut into pieces and dried on a net, it will keep a long
 time, and be particularly useful at sea. One ounce of this
 dry portable jelly, being soaked in water for a quarter of an
 hour to soften it, and then boiled, will make from a pint and
 a quarter to a quart of jelly, according to the season, and
 equally as good as that which is fresh extracted.

Mr. P. prepares a very pleasant restorative for the sick, as
 he informs us, by adding an ounce and a half of sugar, and a
 little salt, to fourteen or fifteen ounces of the jelly, and then
 making

making it into an emulsion with twelve sweet and four bitter almonds, and a little orange peel.

Suet obtained from bones.

Another advantage to be derived from these refuse bones is the fat. Before grinding them to extract the jelly, Mr. P. chops them into pieces about an inch long with a cleaver, throws them into a kettle of boiling water, and lets them boil about a quarter of an hour. The fat obtained in this manner from sixteen pounds of rump and edge bones weighed, when cold, two pounds; and from the same quantity of the bones of the joints he obtained four pounds of solid fat. This, he observes, when fresh, may be used for various culinary purposes; and when it has been kept for some time exposed to the air, it becomes very good tallow for making candles.

V.

Observations on the Effects which take Place from the Destruction of the Membrana Tympani of the Ear; with an Account of an Operation for the Removal of a particular Species of Deafness.
By Mr. ASTLEY COOPER.*

Injury or loss of the membrana tympani does not occasion deafness.

Various causes of its loss or injury.

AFTER referring to a former paper, in which he had proved, by facts, that an aperture in the membrana tympani does not diminish the faculty of hearing, and that a complete destruction of the membrane does not occasion a total loss of that sense, Mr. Cooper observes, that there are various causes by which the membrane may be injured or destroyed. Of these the most common is suppuration in the meatus auditorius. In persons of a delicate constitution and irritable habit the ear-wax is liable to be hardened, gradually bringing on deafness, and then exciting inflammation and suppuration. If this be not remedied, not only the membrane lining the meatus, but that of the tympanum also, will be destroyed, the small bones of the tympanum be discharged, and sometimes considerable exfoliations take place. At Fig. 4, Pl. VI. is a view of the membrane of the tympanum lacerated by a blow on the head; probably from the air being driven into the meatus with violence. Children often introduce small stones, pieces of slate pencil, and even pins, into their ears,

* Abridged from the Philosophical Transactions, 1801, p. 435.

in extracting which considerable lacerations have been made in the membrana tympani. Fig. 5 shews one torn in attempting to remove a pin.

The membrana tympani may be easily seen in some persons, by directing the rays of the sun, or a condensed light from a common lamp, into the ear: but this is not the case in all; for the meatus differs considerably in different persons, both in its depth and diameter. If the ear be clear of wax, the membrane has a bright tendinous appearance; and an aperture in it appears as a dark spot, which, by the silvery surface of the membrane surrounding it, is rendered distinctly perceptible. If there be an aperture, air also, upon blowing the nose with violence, will be forced with a whistling noise through the ear; the smoke of tobacco may be driven from the mouth through the ear; or water may be injected from the ear into the throat.

How the membrane may be seen, and

its appearance.

Means of discovering an aperture in it.

If the whole of the membrane be destroyed, and three out of four of the small bones of the tympanum be removed, an almost total deafness ensues; but the ear, after a time, begins to recover its powers, and, in the end, regains them, with that degree of imperfection only, which was described in the case of Mr. P——, in Mr. Cooper's former paper. When the membrane of one ear only is destroyed, a greater degree of deafness takes place in that ear, than would happen in either, were the membrane destroyed in both. This probably arises from the diffuse, into which the imperfect ear falls. Thus Mr. G——, at an early period of life, lost a great por-

Effects of the destruction of the membrane.

Fig. 3.

tion of the membrana tympani of the left ear; and as he heard somewhat better with his right ear, he was little in the habit of employing the left, till at length he considered himself almost totally deaf in it. Becoming deaf in the right ear, however, and consequently obliged to employ the left, he found it by no means deprived of its powers.

These observations have induced Mr. Cooper to try the effect of an operation, which has proved successful in several instances of one species of deafness,—that which arises from obstruction of the Eustachian tube. Of this obstruction there are several causes. A common cold, affecting the parts contiguous to the orifice of the tube, may prevent the free passage of the air into the tympanum. The deafness thus occasioned is in general temporary; but it may become per-

Cure of a species of deafness.

The Eustachian tube may be obstructed from several causes.

manent,

manent, if a frequent recurrence of such attacks produce permanent enlargement of the tonsils. The scarlet fever occasions ulcers in the throat, which, in healing, frequently close the Eustachian tubes. A venereal ulcer may have the same effect. The tube has been closed by an extravasation of blood in the tympanum. And in one instance a stricture in the tube rendered the passage extremely difficult. In this case, by forcing air from the mouth into the cavity of the tympanum, and then pressing gently on the ear to expel part of the air from the cavity, an immediate increase of the power of hearing was produced. These are the most common causes of obstruction in the Eustachian tube; and Mr. Cooper has reason to think, from the experience he has already had, that they may all be remedied by puncturing the membrana tympani. In support of this opinion he gives four select cases, one of which is the following:

Case of deafness cured by puncture of the membrane of the tympanum.

Mr. Round, of Colchester, consulted Dr. Baillie respecting his son, Mr. John Round, aged seventeen, who had laboured, from his birth, under such a degree of deafness, as would have incapacitated him from engaging in business. Dr. Baillie, having satisfied himself that there was no nervous defect in the ear, referred him to Mr. Cooper. He found that this gentleman had been born with an imperfect state of the fauces, which rendered him incapable of blowing his nose; that the Eustachian tubes had no openings into the throat, and, therefore, that he was unable to force air from the mouth into the ear. The auditory nerves, however, were perfect; for he could distinctly hear the beating of a watch, if placed between the teeth, or against the side of the head; and he had never perceived any buzzing noise in his ears. Our author therefore advised him to submit to the operation of perforating the membrana tympani; to which he cheerfully consented. The moment this was done, a new world was opened to him; and the confusion produced by the number of sounds, which immediately struck his ear, made him sink upon a chair, almost in a fainting state. From this state he recovered in about two minutes; and, finding that his hearing was completely restored upon the one side, he wished the operation to be performed upon the other; which was immediately done, with the same happy result, and without his experiencing the same confused sensation as before. Near two months after the operation,

operation, Mr. Cooper had the pleasure to receive an assurance from him, that he had suffered no relapse, nor any inconvenience from the openings which had been made, and that his hearing continued perfect.

The operation consists in passing into the ear a canula, of the size of a common probe, in which a trocar is concealed: the canula is to rest upon the membrana tympani, and the trocar is then to be thrust through the membrane. The trocar should be so adjusted, as not to pass more than one-eighth of an inch beyond the canula, to prevent its reaching the opposite side of the cavity of the tympanum. Should it however touch the periosteum of the tympanum, it can be productive of no serious harm. The aperture should be made in the anterior and inferior part of the membrane, under the handle of the malleus, which must not be injured in the operation; and it is therefore necessary, that the operator be acquainted with the exact situation of this bone. Though the membrana tympani is vascular, the vessels are so small, that they bleed but little; and therefore, if much blood be discharged, the operation cannot have been properly performed. In an ear otherwise healthy, the operation is attended with so slight a degree of pain, that, when it has been performed in one ear, the patient expresses no unwillingness to submit in the other. The sensation it occasions is momentary; and no subsequent inconvenience of any kind arises: though if the ear have been previously irritated by stimulating applications, the operation will be painful, and should be deferred, till the inflammation has subsided.

Mode of performing the operation.

As this operation affords relief only in cases of closure of the Eustachian tube, attention should be paid to the following criteria of this defect.

Cases in which it affords relief.

If a person, on blowing the nose violently, feel a swelling in the ear, from the membrana tympani being forced outward, the Eustachian tube is open. Though the tube be closed, if the beating of a watch placed between the teeth, or pressed against the side of the head, cannot be heard, the operation cannot relieve, as the power of the auditory nerve must have been destroyed. In a closed Eustachian tube there is no noise in the head, like that accompanying nervous deafness. Lastly, it is right to inquire, whether the deafness were immediately preceded by any complaint in the throat.

Criteria for distinguishing them.

The

The causes of deafness are numerous, and many cases may be relieved by surgery.
Nervous deafness.

The causes of deafness are extremely numerous; and many of those which affect only the meatus auditorius, the membrana tympani, the cavity of the tympanum, and the Eustachian tube, admit of relief from surgery.

But there is one species, in which it would be absurd to expect this from any operation upon the membrana tympani. This occurs more frequently than any other, happening generally in old persons; but sometimes, in the delicate and irritable, in the earlier stages of life. Anxiety and distress of mind have been known to produce it. Its approach is generally gradual: the person hears better at one time than at another; a cloudy day, a warm room, agitated spirits, or the operation of fear, will produce a considerable diminution in the powers of the organ. In the open air the hearing is better than in a confined situation; in a noisy, than in a quiet society; in a coach when it is in motion, than when it is still. A pulsation is often felt in the ear; a noise, resembling sometimes the roaring of the sea, and at others the ringing of distant bells, is heard. This deafness generally begins with a diminished secretion of the wax of the ear, which the patient attributes to some unusual exposure of the head to cold; and this continues as long as the disease remains. It may be cured in the commencement by the application of such stimulants, as are capable of exciting a discharge from the ceruminous glands; for which purpose they should be introduced into the meatus. But if these be used so as to irritate, without exciting a discharge, they are rather prejudicial than otherwise. In cases of this kind the operation has afforded no farther relief than diminishing the noise in the head.

May be cured in the commencement by stimulants.

Deafness from the generation of a solid substance in the labyrinth.

Another cause of deafness is probably irremediable. This is the generation of a solid substance in the labyrinth of the ear, instead of the water with which it is naturally filled. Mr. Cline, dissecting the head of a young man born deaf, and consequently dumb, found all the parts of the organs of hearing perfectly formed, but the vestibule, cochlea, and semicircular canals, were filled with a substance of the consistence of cheese.

These instances of deafness Mr. Cooper thought it right to describe, because they are liable to be confounded with that which arises from a closed Eustachian tube.

EXPLANATION OF THE FIGURES. Plate VI.

Fig. 1 shews the external ear, the meatus auditorius, membrana tympani, and Eustachian tube.

A, the meatus.

B, the membrana tympani.

C, the cavity of the tympanum.

D, the Eustachian tube.

Fig. 2 shews the perforating instrument as it is introduced in the operation.

Fig. 3 the membrana tympani of Mr. G——, of which only that part which appears of a lighter colour remains.

Fig. 4 the membrane lacerated by a blow.

Fig. 5 the membrane lacerated in an attempt to extract a pin.

Fig. 6 shews the membrana tympani of a medical man in the city, having a fungus projecting through it. In this ear he is considerably deaf.

Fig. 7 the other membrane of the same gentleman.

Fig. 8 one of the membranes of Mr. P——, whose case was described in the former paper.

Fig. 9. A membrana tympani in its natural state, shewing the attachment of the manubrium to the malleus.

Fig. 10 the appearance of the membrane after having been punctured.

VI.

Note respecting the Absorption of Nitrous Gas, by Solutions of Green Sulphate and Muriate of Iron. By Mr. H. DAVY, Director of the Laboratory, and Lecturer on Chemistry to the Royal Institution.—(From the Author.)

WHEN nitrous gas is brought in contact with solution of green sulphate, or green muriate, of iron, it is rapidly absorbed; the colour of the fluid alters; and it becomes, when saturated with the gas, dark brown, and almost opaque.

Solution of green sulphate, or muriate of iron, absorbs nitrous gas;

Solution of sulphate, or muriate, of iron, impregnated with nitrous gas, apparently undergoes no change at low temperatures, when preserved from the contact of the atmosphere.

and undergoes no change at low temperatures.

But

unless exposed to the air, when it absorbs oxygen, becomes acid, deposits red oxide, and affords a little ammonia.

The impregnated solution, *in vacuo*, emits its nitrous gas without change.

The same solution, heated, emits nitrous gas, deposits a little red oxide, and contains ammonia.

Theory.

The nitrous gas is first absorbed by simple affinity; probably from the attraction of the iron for oxygen.

Exposure to air converts the nitrous gas into acid; a portion of which, and also of the water, are decomposed by the iron converted into red oxide.

Heat increases the tendency of nitrous gas to fly off, and also that of the iron to decompose it, and water.

Hence red oxide is formed by the oxygen of this gas and of the

But if it be exposed to it, it rapidly absorbs oxygen, loses its colour, and becomes acid to the taste. In this case, the green oxide of iron is converted into red oxide; and a small quantity of ammonia is formed.

When a solution of sulphate of iron, impregnated with nitrous gas, is placed under the receiver of an air pump, in proportion as the pressure of the atmosphere is removed from it, it gives out its nitrous gas. When the mercury in the gage stands at about $\frac{3}{10}$ of an inch, it becomes almost wholly freed from it, recovers its colour, and is found unaltered in its properties.

When solutions of green sulphate, or muriate, of iron, impregnated with nitrous gas, are exposed to the heat of a spirit lamp, nitrous gas is produced from them in a very pure state, the fluids lose their dark colour, and a small quantity of yellow oxide of iron is thrown down in them. If examined after this process, they are found to contain a little ammoniac, combined with some of the acid; and the oxide of iron dissolved is green oxide.

The theory of these appearances is obvious.

The absorption of nitrous gas, by solutions containing oxide of iron, at its minimum of oxidation, at common temperatures, appears to be owing to a simple combination between the gas and the fluid; owing probably in some measure to the modified affinity of the green oxide of iron for oxygen; for the red sulphate and muriate of iron have no affinity for nitrous gas.

The changes taking place in the impregnated solutions, when exposed to the atmosphere, evidently depend upon the conversion of the nitrous gas of the solution into nitrous acid, by the absorption of oxygen; and upon the subsequent decomposition of a portion of this nitrous acid, and of the water of the solution, by the green oxide of iron.

Heat seems to act upon impregnated solutions, by increasing the tendency of nitrous gas to assume the elastic form, and by increasing the affinity of the green oxide of iron for oxygen. In consequence, a portion of nitrous gas flies off, and another portion is decomposed; its oxygen combining with the green oxide, and its nitrogen with the hydrogen of a small quantity of water, which is acted upon by a similar attraction.

The absorption of nitrous gas by solution of common sulphate of iron was discovered by Dr. Priestley. It has been employed

employed by Mr. Humboldt for the purpose of ascertaining the quantity of nitrogen mingled with nitrous gas; and that experimentalist, in conjunction with Mr. Vauquelin, has attempted to prove that the process of absorption is owing to an immediate decomposition of the nitrous gas by the water of the solution; in consequence of which nitrate of ammonia is formed.

This conclusion is published in the 28th volume of the *Annales de Chimie*. In the 39th volume of the same work, 30 Messidor, An 9. p. 1. Mr. Berthollet states, that nitrous acid is probably formed during the absorption of nitrous gas by solution of sulphate of iron; in consequence of the evolution of a portion of its nitrogen, and in consequence of the more intimate union of its remaining constituent principles. Yet, in the same paper, he details an experiment on the application of heat to an impregnated solution, which was attended with results similar to those described above; and in consequence of which he is induced to enquire, "If the sulphate of iron is capable of exerting two different actions in nitrous gas; one tending simply to absorb it, and the other to decompose it?" p. 11.

The general account that has been given in this Note of the true nature of the process, is extracted from "Researches, Chemical and Philosophical, concerning Nitrous Oxide, published in June, 1800." The experiments upon the absorption were made under Mercury; and, in consequence, the agency of the atmosphere, which appears to have misled the celebrated foreign chemists just quoted in their conclusions, was avoided.

VII.

On certain Metallic Sulphurets. By PROUST, Professor of Chemistry at Madrid*.

I LONG supposed, that the iron in pyrites was oxidized at the minimum, and, supporting my opinion by some analogies, I published it in the year 1795; but when my attention was recalled to the subject, by reading the Memoir which Vau-

quelin founded opinion, that the iron in pyrites is oxidized.

* Journal de Physique. Thermidor. 9.

quelin has published on the sulphurets, I thought I ought no longer to delay making known the facts which have induced me to adopt a different opinion. I made use of the fine cubical and dodecahedral-pyrites, which are obtained in abundance from an indurated argill, found in the vicinity of San Pedro Marino, near the town of Soria.

Distillation of
pyrites

Four hundred grains of entire pyrites of the size of hemp-feed, distilled by a red heat, yielded,

Of Pure sulphur	-	75 grains
Residuum	-	322
Loss	-	3
		400
Total		400

Four hundred grains of the same of a little larger size, yielded,

Sulphur	-	81 grains
Residuum	-	314
Loss	-	5
		400

A moderately red heat is sufficient for extracting all the sulphur which they are able to yield. In the first moments, a small quantity of aqueous vapour passes over; afterwards, two gases, which may easily be recognised by their smell, namely, the sulphureous and hydrogen-sulphureous, which mutually decompose each other in the water of the receiver, and render it milky. Both are owing to the decomposition of the humidity; the sulphur passes over afterwards, and the gas is no longer perceived.

converts them
into sulphuret.

The abstraction of about 20 parts in 100 of the sulphur from the pyrites, destroys in a great measure their metallic lustre and solidity; and though they preserve their form, they are more voluminous, melted on all sides, and may be crushed between the fingers; they have only the dull colour of an artificial sulphuret.

They contain no
oxygen.

Hence it is evident, on comparing the products, that if oxygen constituted part of the pyrites, we must seek it in the residuum of their distillation; but the following facts annihilate the hope of finding it there.

Proof.

When we treat the different oxides of iron with sulphur, or cinnabar, in a red heat, the results are, sulphureous gas, and common sulphuret of iron. If therefore the pyrites contained

oxygen,

oxygen, it is evident that the latter could not escape the attraction of the combustible substance in a high temperature.

When treated with carbon, pyrites produces only sulphurated hydrogen; but if first deprived of 12 or 20 hundredths of sulphur, it presents only sulphuret, or iron saturated with sulphur, in the proportion of 60 to 100. It is soluble in the sulphuric, muriatic, and dilute nitric acids, affording sulphurated hydrogen in abundance.

Pyrites, therefore, according to these results, is nothing more than a sulphuret formed by nature in the humid way, and surcharged with an excess of sulphur, as if to ensure the duration of her work.

The pyrites will undoubtedly be found to differ greatly from each other with respect to this excess of sulphur; for, according to Henkel, there are some which yield 25, 28, even 32 per cent. of sulphur. It is therefore to this surplus that the product of this distillation belongs, and not to the sulphur, which has been combined with iron by the invariable law of the proportions; for the metal, when saturated with $\frac{60}{100}$ of this combustible, yields none on being exposed to that temperature which deprives the pyrites of its excess.

The pyrites, besides their different known uses, are of great use in a laboratory. We may fill a crucible with them, cover the powder with about a third part of filings, sprinkle over these a little charcoal powder, and afterwards bring the whole to a red heat, without carrying it so far as to reduce them to the state of fusion. In this manner we obtain a homogeneous mass, very convenient for procuring hydrogen in abundance.

By what I have just said, I do not however mean to imply that all the pyrites resemble each other. Those, for example, which possess the property of becoming vitriolized, approach perhaps the nearest to the sulphuret of iron without excess; for it is certain that the pyrites most charged with sulphur are at the same time those which resist the tendency of the elements to destroy them the longest.

The pyrites of Soria contains a little chalk, sand, and argill, but not the slightest trace of copper: its solution in the nitric acid is reduced to the minimum of oxidation by means of sulphurated hydrogen; and the yellow powder which separates from it is nothing but sulphur.

Pyrites is a sulphuret overcharged with sulphur.

They differ much; and only yield their surplus by distillation.

Easy method of procuring hydrogen.

The least sulphurated pyrites are soonest vitriolized.

The

Natural production of red ochre. The pyrites undergo a slow decomposition, by which oxygen is substituted in the place of the sulphur, without their losing any thing of their dimensions; they are then nothing more than red oxide. When the waters transport, divide, and attenuate the oxidized pyrites, they become changed into red ochre: of this kind is that which in Spain is termed *Almagné*, from the name of the village where it is found. It is employed for painting houses, marking sheep, colouring the Seville snuff, polishing glass, &c. This earth, when distilled, yields sulphureous acid in abundance: it announces its origin by the remnant of sulphur which it contains.

Yellow ochre. As to the beautiful yellow ochres, which acquire a red colour by merely losing their humidity, they proceed from the spontaneous decomposition of the spathose ores: we therefore find them to contain lime and manganese. I have observed this conversion of the spathose ore into the state of yellow ochre in a very distinct manner in certain veins; that is to say, the oxides of iron and manganese, when both at the minimum, and saturated with carbonic acid, raise themselves to the maximum, by abandoning the acid, which can no longer remain united with them in this state.

Umber.

Analysis of umber shews it to be vegetable. If this earth be a vegetable residue, as cannot be doubted, its origin is well confirmed by its analysis, for it is a compound of oxide of iron and manganese, both at the maximum, of argill, of sand, &c. As to the argill, it abounds in the ashes of certain kinds of wood; I have found it in large quantity in that of the olive and careb trees; in that of the holm (*encina* in Spanish) I have found the calcareous phosphate, which I neglected to announce at the proper time. In addition to my second memoir on Prussian blue, I have to add, that ox's blood certainly contains manganese.

Sulphuret of Mercury.

Mercury in cinnabar is not oxidized. Artificial cinnabar constantly yields 85 per cent. of mercury on the one hand; on the other it relinquishes 14 and $14\frac{1}{2}$ of sulphur to the antimony which is used for effecting its decomposition. The mercury is not therefore originated in cinnabar.

In

5. In my youth I made two experiments, which might have cost me very dear. I wished to convert mercury into cinnabar in the dry way, as I had done by employing the oxides in the humid way. Four ounces of corrosive muriate, and four ounces of red oxide, triturated with sulphur, were exposed to the fire, each mixture in a separate retort. In less than half an hour, two explosions took place, which were heard throughout the extensive works of La Salpêtrière. My brother, who conducted the first experiment, being suddenly overwhelmed with a thick smoke of sublimate, had nearly lost his life, and his lungs were long afterwards disordered. The result of my operation was, that the dome of the furnace was thrown into the air, whilst the door of the ash-pit was shattered against a wall, and narrowly escaped striking me in the stomach.

Dangerous explosions, by attempts to form cinnabar with oxidized mercury, by heat.

The powder which arose from the detonation of the oxide mixed with sulphur, according to the method of Bayen, is cinnabar of a violet-red colour.

The æthiops, prepared with the aid of fire, reddens spontaneously in course of time, in the oxidizing vessels.

Mercury poured into a retort with melted sulphur always occasions an inflammation; but if both have been previously heated, the union takes place, and the æthiops affords cinnabar without flame. As to that which accompanies the process used by the Dutch, it deserves to be better examined than has hitherto been done.

On the inflammation of the common processes.

Hydro-sulphurated water, poured gradually into a solution of sublimate, decomposes it entirely. The precipitate is mild muriate, and muriatic acid is disengaged. This result proves, that there is not only more oxygen in the oxide of sublimate, but also, as Berthollet has remarked, more marine acid. If, on the contrary, we pour the solution of sublimate into the hydro-sulphurated water, the whole becomes precipitated in the form of æthiops, and the muriatic acid remains alone.

Corrosive sublimate contains more oxygen and more acid than the mild muriate.

Remarkable fact.

The name of *sweet* muriate brings to my recollection a fact recorded by Lemery in the Memoirs of the Academy. He knew an alchemist, who eat the mild muriate like bread; he has seen him swallow four ounces at a time, and he assured him that he took from time to time a like dose, to purify his blood, as he said. This anecdote, the authenticity of which cannot be suspected, induces me to ask what we are to think of the 18 and 24 grains of *mercurius dulcis* which physicians

Anecdote, to shew the inefficacy of mild muriate as a medicine. It was not the muriate. W. N.

are in the daily habit of prescribing? I greatly fear that it may be much the same with regard to its effects as with those of sedative salt, and so many other medicines, which have nothing to recommend them, but the honour which is done to them, of affording them a place, from age to age, in our dispensatories and catalogues of the *materia medica*.

Mild muriate treated with sulphur;

I find also in my notes of the same period, that the mild muriate, treated with sulphur in a retort, affords cinnabar and corrosive muriate; the mild muriate is therefore divided into two portions; one of which is converted into cinnabar, and the other charges itself with the oxygen and acid of the first.

also turpeth.

That turpeth mineral, treated in the same manner, is changed into cinnabar, and quits the oxygen, which goes to form sulphureous acid.

The concentrated sulphuric acid decomposes cinnabar, like the pyrites and other sulphurets, yielding to the metal the oxygen which they require; hence the sulphureous acid, &c.

Cinnabar in the humid way.

Mercury prefers sulphur to oxygen.

Mercury having much more affinity for sulphur than for oxygen, never fails to shew its preference for this combustible. It is not subject to the law which enables zinc, tin, antimony, &c. to combine with sulphur, without abandoning the oxygen.

Liquid sulphurets decomposed by crude mercury;

F. Hoffman was, I think, the first who thought of decomposing the ammoniacal sulphuret by means of mercury. Baumé and Wiegleb have since occupied themselves with the subject, and in a more extensive manner.

which takes the sulphur, and becomes cinnabar.

Mercury, poured into flasks containing sulphuret of potash, or of ammonia, decomposes them entirely, and reduces them to potash and ammonia: in the space of a few days it passes from the black to the red colour. If mercury required oxygen in order to assume the colour of cinnabar, whence should it take it? This process is certainly of a very disoxidating nature.

Mercurial salts and oxides also.

The nitrates, muriates, sulphates, and mercurial oxides of every kind, all yield æthiops in the first moment of their mixture with the sulphurets: they all become violently heated. In order to accelerate their coloration, it will be sufficient to place the flask with the mixture upon burning coals; in an instant they begin to grow red at the points where the heat exerts its action. Is it sulphurated hydrogen which they then lose? For my part, I cannot tell.

All

All these cinnabars differ with respect to their shades of colour and fineness; some are of a tinge approaching to purple, violet, &c. That of sublimate combines with a great degree of tenuity, a vivid scarlet brilliancy. It is much superior to the richest vermilion, and it is to be wished that painters might become acquainted with it.

These cinnabars differ. A very beautiful pigment.

Others are pulverulent, of a dark or dull colour; such are those which the sulphuret of potash yields; they have neither the lustre nor the tenuity of the others, for they are crystalline. For the rest, all these cinnabars present no extraordinary appearances in sublimation; by this process they lose the brilliancy which they owed to their state of division.

Tin, which has so great an affinity with oxygen, takes however nothing else than sulphur from cinnabar; if the latter contained also oxygen, it would take it from it with the same facility as it does the sulphur; and the presence of the one would certainly be no impediment to the tin becoming charged with the other: for if we heat a mixture of cinnabar and oxide of tin at the maximum, we obtain mercury, sulphurated oxide of tin, and sulphureous acid. This last is here produced, as in the case where sulphur is treated with the oxide of tin, by a reduction which brings this oxide from the maximum to a minimum of oxidation, of which I do not yet know the numerical value.

Tin takes sulphur from cinnabar; but no oxygen: that principle not being present.

Sulphuret of Arsenic.

This is also one of those which have long deceived me by the analogy which its transparency and colour seems to indicate.

The sulphurets of arsenic contain no oxygen.

The arsenical acid and white oxide, treated with sulphur, lose their oxygen, yield sulphureous gas, and are reduced into a sulphuret, which is transparent, vitreous, of a yellowish red colour, and capable of being raised in distillation.

Pure arsenic, treated in the same manner, yields the same kind of sulphuret, of perfect volatility, colour, and transparency.

In whatever ways we may expose these sulphurets to the action of pulverised charcoal, iron, tin, &c. they remain unalterable. Minute portions of sulphureous gas, and sulphurated and arsenicated hydrogen, appear at first in consequence of the moisture, but nothing more.

The native, scaly, flexible orpiment melts quietly, and forms a vitreous, red, transparent mass, resembling realgar, and unalterable by the action of charcoal. There may exist natural sulphurated oxides of arsenic, but certainly these are not such as are formed by an elevated temperature. The native realgar of Ronda in Andalusia, is also a metallic sulphuret without oxygen.

Sulphuret of Copper.

The sulphuret of copper exhibits a second instance in the mineral kingdom of sulphurets with a surcharge of sulphur.

Characters of sulphuret of copper.

As the lights of analysis have hitherto been wanting, in order to point out to mineralogists the real characters of this sulphuret, they have always described it in an imperfect manner, or confounded it with other mineral productions. In its purest state, its colour is always a deep blue, violet, or mixed with the copper tinge of indigo, if rubbed with a smooth substance. Its colour is liable to be disguised by a mixture of carbonate of copper, red oxide of iron, &c. But when we separate these by solution, the sulphuret is restored to its real colour.

Variations from impurity.

More commonly the sulphuret of copper is disguised by its intimate combination with the other metallic sulphurets.

Combined, for example, with the sulphuret of iron, it affords the copper-coloured pyrites, in which the existence of the blue sulphuret may easily be demonstrated.

If with these two sulphurets, considered as the base, are combined those of antimony, lead, arsenic, mercury, silver, zinc, &c. each separately, there results a series of ores of copper, rendered grey by as many different metals, but which do not on that account, as mineralogists believe, necessarily contain silver.

Compound ores of copper.

If with the two first sulphurets we combine in idea the 2d, 3d, 4th, and 5th of these which we have just mentioned, we have in these combinations as many complicated ores of copper. Amongst those which are brought from America, there are others likewise compounded with native silver, the carbonates of iron, manganese, sulphate of barytes, &c. Such are the different species of mineralizations which mineralogists have indiscriminately comprehended under the two classes of white and grey ores of copper.

The

The grey ore of copper of La Cren, in the kingdom of Valentia, is of this kind: it is composed of four sulphurets, that of copper, of iron, of antimony, and of mercury. Deposited in masses in the calcareous breccias formed by the remains of mountains which no longer exist, it undergoes a decomposition at its surface, which converts three of the sulphurets into oxides, whilst that of mercury remains entire, and imparts to the decomposed ore a brilliant vermilion hue. At the centre there is always a nucleus composed of these four sulphurets in their entire state. The analysis of this mineral, given by Fernandez, is in the *Annales*: but I return to the sulphuret of copper, from which I did not intend to digress.

Those which I have had opportunity to examine contain from 14 to 15 per cent. of sulphur, which is easily extracted from them by a moderate heat, and what remains in the retort is always the blue sulphuret, saturated according to an uniform proportion. This proportion is 18 per cent. like that of the artificial sulphuret. If a native sulphuret of copper leaves 86 of residuum, we may precipitate its nitric solution by sulphurated hydrogen; and the precipitate separated from the excess of sulphur re-produces 86 parts of sulphuret of copper. Hence we see, that though the native sulphuret is subject to an excess of sulphur, it does not on that account differ from the artificial sulphuret, when it has been deprived of this excess.

Copper pyrites, like that of iron, contains an excess beyond the state of sulphuret.

By the action of a red heat, the oxides of copper, mixed with sulphur, yield only blue sulphuret. This metal does not afford a sulphurated oxide, either in nature or in the products of art. Its formation is always attended with a considerable extrication of heat. It is astonishing, if it be duly considered, that it could ever for one moment have been mistaken for a combustion.

Copper sulphurets contain no oxygen.

The blue sulphuret dissolves in copper, and forms the black coppers, independently of the iron which they may contain. Acids of 10 or 12 degrees separate it from these coppers without decomposing it.

Black copper.

On the Fuming Muriate of Tin.

Since the year 1777, I have been in the habit of preparing this muriate with corrosive sublimate and pulverised tin; and though I never thought of publishing this process, it was because I imagined it to be in common use in every laboratory.

Fuming muriate of tin prepared without amalgamation.

But

But as, in the latest treatises of chemistry, the ancient process of amalgamation is still prescribed, I think it may be useful at present to recommend the use of the mere pulverised tin.

These are the details which I find in my notes of that period; they shew that the following proportion is the best:

Instructions.

Twenty-four ounces of sublimate and eight ounces of tin yield nine ounces of fuming liquid.

Conceiving that some advantage might be obtained by augmenting the proportion of sublimate, on account of the great excess of pure and semi-oxidised tin which is found in the residuum, I made the following trial:

Experiment.

Thirty-two ounces of sublimate and eight ounces of tin yielded ten ounces of the liquid; hence it appears, that the expenditure of eight ounces of sublimate is not compensated by more than one ounce more of liquid.

The acid is not oxidised in the fuming muriatic.

I shall shew, upon another occasion, that in the fuming muriatic of tin, as well as in the corrosive muriatic of mercury, the bases only are oxidated at their maximum, whilst the muriatic acid remains in its ordinary simple state.

VIII.

A Memoir on the Method of Bleaching the Paste of Paper.

By CITIZEN LOYSEL *.

Berthollet's bleaching process.

THE advantages of the method of Citizen Berthollet for bleaching thread and piece goods, by means of the oxygenated muriatic acid are universally known. Citizen Chaptal has usefully applied this invention, to restore the colour of prints and printed books; and he has also simplified one of its most important parts in his new processes respecting the art of applying the lixivium.

Advantages of applying it to paper.

The adoption of Citizen Berthollet's method to the art of paper-making, is capable of carrying this branch of industry to a still greater degree of perfection, particularly in France. We are abundantly supplied with the raw materials proper for manufacturing paper; but according to the present processes of our paper mills, there is only a very small portion of the

* Translated from the *Annales de Chimie* XXXIX. 137.

rags which can be used to manufacture fine white paper. All the residue is condemned to the fabrication of papers of inferior quality.

The process of bleaching the paste of the paper maker, even when produced from the most common rags, will communicate to it the quality of the best sort. By these means our paper manufactories may supply our wants in fine white paper, and even obtain the preference in foreign markets. The result of this operation would be, that a greater number of workmen would find employment, and the advantages of this increase of industry would be of still greater national value, than even the foreign export which might be expected.

The success of bleaching the paste of paper by the method of Citizen Berthollet is no longer problematical. The application which has been made to the paper used in making assignats, has placed this question beyond all doubt as to its solution. Actual trial and practice.

It was at the commencement of the year 2, that the committee of assignats and monies of the National Convention, which I was a member, resolved to employ this method, together with that of stereotype which had been adopted, to oppose new obstacles to the practice of forgery, In making paper for assignats.

We particularly consulted Citizens Berthollet, Fourcroy, and Guyton on this enterprize. Their approbation of the project, and the information they afforded us, soon gave us the power of realising it. We were also assisted with the knowledge of Citizens Welter, Athenas, Alban, Carny, Marchais and Ribaucour, who with great zeal communicated their processes, and permitted us to inspect their several manufactories,

I shall not here relate all the previous experiments we made before we established our works on a large scale, but shall content myself to point out concisely the manner of our commencement, the agents we employed, and the means which to us appeared the most simple to obtain our desired purpose. I shall afterwards add a few observations respecting the means of still greater perfection, which the advancement of the science since that time has rendered the same operations capable of. Order of narration.

Our first processes were executed precisely according to the method of Citizen Berthollet. The rag was subjected in succession The rags were bleached at the first trial.

Difficulty of using the bleaching liquor without alkali.

succession to different lees, to baths of the bleaching liquor, and sulphuric acid pointed out in his memoir. Berthollet had shewn, and we were also convinced by our own experience, that the gas is less confined in the simple fluid, prepared without addition of fixed alkali, than it is in that which contains potash or soda; and that it is consequently more disposed to separate and enter into new combinations. We therefore at first made use of this simple liquor; but the workmen soon exhibited a strong repugnance to its use on account of the fumes it emits, which are extremely inconvenient, even when chalk is diffused in the liquor. This inconvenience forced us to abandon it, though with regret. This sacrifice was so much the more considerable, as it occasioned a loss of time, and considerable increase of expence. We decided that we would receive the gas in a solution of potash; but as the doses in which this alkali may be used have limits of great extent, we endeavoured to keep as near as possible to that preparation which is sufficient to prevent the spontaneous disengagement of the gas, and by that means cause the liquor to lose the odour we were desirous of avoiding. This dose was 5 kilograms of potash to 100 litres of water, (11 pounds avoirdupoise, to $21\frac{1}{2}$ ale gallons.)

The rags became very white, but when opened by the mill were less so.

The rags bleached in this manner became of the most brilliant white. Nevertheless, a part of this perfection disappeared, when the rag was converted into paste, and that paste into paper. It was easy to discover the cause; namely, that the interior parts of the thread in the rag were less exposed to the action of the liquor than those at the surface. This motive determined us to abandon the bleaching of the rags, and to operate upon the paste itself.

The paste was therefore bleached

We were here opposed by new obstacles. When the rag is converted into a paste proper to be worked, its coherence is such that it settles, and no longer permits the lees and baths of the bleaching liquor to penetrate through all its parts, in consequence of which property the paper was found to have veins and different shades of colour. We remedied this inconvenience, by taking the matter in a mean state between the rag and the paste proper to be converted into sheets of paper. We succeeded in this respect by destroying the texture of the rag under the first cylinder so as to separate its fibres, an operation which usually lasted two hours for a pile of 50 kilograms.

in its half prepared state.

Thus

Thus it was, that by successively avoiding the extremes of too much and too little mechanical connection, we advanced towards our object.

The apparatus which Citizen Welter imagined, and of which Citizen Berthollet has given a description in the first volume of the Journal of Arts and Manufactures, is applicable to all the methods which can be employed to procure the different kinds of bleaching liquor, whether the water of the receiver contain fixed alkali or not; whether the muriatic acid be used on the oxide of manganese, or the gas be obtained by sulphuric acid, upon the mixture of oxide of manganese and muriate of soda. This apparatus is particularly preferable to all others in the case where the water of the receiver contains no alkali, because the absorption of the gas is favoured by its being brought into contact with the water at a great number of surfaces. But as we had determined to use a solution of potash, we were able to make some modifications of this apparatus.

1. The three inner partitions of the receiving vessel were reduced to one only. Ours was formed of a tub containing another tub inverted, and both were covered with sheet lead.

2. The size of the tubes of communication was so considerable, that we had nothing to fear from absorption during the course of the distillation.

3. Lastly, the practical skill of our workmen in managing the fire, and the advantage of having only one opening to late enabled us to suppress the intermediate vessel.

Description of the apparatus used in preparing the oxygenated muriatic acid in bleaching the paste of paper for assignats.

Fig. 1, Pl. VII. Plan of the apparatus.

Plan.

1, 1, 1, &c. Eight furnaces, having a chimney of sheet iron common to each pair of furnaces.

2, 2, 2, &c. Eight vessels of cast iron, containing sand.

3, 3, 3, &c. Eight matrasses, balloons, or bottles of stone ware, compact and well baked, intended to contain the materials which afford the gas. Each matrass must be filled only to one-third of its capacity at most. Bodies of glass of little thickness may also be used for this purpose.

4, 4, 4, &c. Tubes of glass to conduct the gas into the receiver. Or these tubes may be made of lead.

5. The

Plan.

5. The receiver. It is composed 1. of an external vessel, covered with plates of lead well foldered together, and provided near its bottom with a cock 6, to draw off the liquor when prepared. 2. Another vessel, 7, likewise covered with plates of lead within and without. This second tub is inverted in the first to contain the gas in proportion as it is disengaged, and to keep in contact with the water of the receiver, that portion of gas which had not time to be dissolved, in passing through that fluid.

There is a hole, 8, in the upper part of this second vessel. It serves to suffer the common air to escape when water is first poured into this receiver, and it is afterwards closed with a stopper of lead or cork, covered with paper, soaked in starch, and fastened to the cork by a piece of cloth or bladder, before the operation began.

Vertical section. Fig. 2. Vertical section of the apparatus.

Fig. 3. Elevation of the apparatus.

The disposition of the furnaces about the receiver, and the circular form of the receiving vessels, was rendered necessary by the local circumstances of the laboratory in which our operations were carried on. In other circumstances square vessels might be employed, and all the furnaces might be ranged in a right line under a common chimney.

One thousand litres of water are placed in the receiver, holding in solution fifty kilograms of white purified and calcined potash.

When the disengagement of gas is effected by the muriatic acid, the materials are used in the following doses :

Oxide of manganese	- - - - -	24 kilograms
Muriatic acid at 20 degrees of density according to the barometer of Baumé,	} - - - - -	68 — 92

which makes for each of the eight distilling vessels $11\frac{1}{2}$ kilograms of materials.

Charging and
distillation.

The operation is begun by charging the receiver with 1000 litres of alkaline water, after which the aperture 8 is closed with its stopper well luted. Each matras is then placed in its sand-bed; and pulverized manganese is introduced. The muriatic acid is poured upon the manganese, and the stoppers into which the tubes of communication pass, are duly placed. The juncture is luted with paper soaked in starch.

starch. And the lute is left to dry from six to twelve hours, after which the fire is lighted in the furnaces.

The process of distillation lasts from ten to twelve hours. When it is finished the tubes are unluted, the fire extinguished, and the matrasés suffered to cool in their sand beds, till the temperature of these beds has descended to 60 or 70 degrees, (centigrade) at which period, water of the same heat is poured into the matrasés. The water dilutes the residue of the distillation, which mixture is to be poured out, and the vessels suffered to cool in baskets containing straw. If the precaution of introducing hot water in this manner upon the residue were not taken, it would become so solid when the operation is performed with sulphuric acid, in the manner we are about to describe, that it could not be extracted without much trouble and danger of breaking the vessels.

If the disengagement of the gas be made by sulphuric acid, Process with sulphuric acid. the following doses are used :

Oxide of manganese	- - - -	25 kilograms
Muriate of soda	- - - -	70
Sulphuric acid at 50 degrees of density		25
		120
Total		120

The acid is to be diluted with an equal bulk of water, or 16 litres, which will reduce its density to 31 degrees.

The eighth part of this for each matrasé amounts to 14½ kilograms.

The oxide of manganese and muriate of soda being pulverized are mixed together. The matrasé is to be charged and the operation conducted as before described. This method is the most economical, because the sulphuric acid is cheaper than the muriatic, and also because it is practicable to obtain from the residue of the distillation, the soda of the muriate which is converted into sulphate of soda; that salt being decomposable by well known processes.

In order to measure the force of these liquors, or their bleaching power, we made use of the solution of indigo prescribed by Citizen Des roizilles, which is prepared in the following manner : To ascertain the strength of the bleaching liquor

In a glass matrasé put of concentrated sulphuric acid at 66 degrees of density, seven parts by weight, and of pulverized indigo one part; agitate the mixture, and plunge the ball of the By indigo.

the

the matras to half its depth in water moderately heated, agitating it from time to time. The solution will be effected in two hours, after which it is to be diluted in 992 parts of water. This is the proof liquor. The stronger the bleaching liquor, the greater number of parts of the solution of indigo it will render colourless, and we may by this proof determine the doses of each kind of bleaching liquor to be employed, together with water, so as to compose a bath proper for immersing the substance intended to be bleached.

One part by measure of the bleaching liquid prepared as before mentioned, will usually destroy the blue colour of nine parts of the proof solution of indigo; it was of the same strength as that of Javel, prepared by Citizen Alban.

Choice and Preparation of the Rags.

Selection of the materials for paper, quality of rags, &c.

The strength or tenacity of paper depends upon the staple or fibre of the material from which it is made. Rags of new cloth and cordage compose a paper more tough than old rags, and the first of these materials presents a great variety on account of the quality of the hemp or flax of which they are formed. Rags of fine new cloth, whether raw or bleached by the oxygenated muriatic acid, stand in the first rank, after which cordage and old rags may be classed.

Bank or note paper.

Paper intended for bills of exchange, or other commercial and legal instruments ought to be tough, in order that it may not be easily torn when thin, for this paper the materials of the first class must be intirely, or in large proportion employed. The price which the consumers are disposed to pay for this article, is sufficient to indemnify the manufacturer for his care and industry, as this kind of paper is sold in France for 5 or 6 francs the kilogram.

Common paper.

The other papers also require to be more or less tough, according to their thinness, and the use to which they are applied, but a clear white colour is sought in paper of every description. The first operation to which the rags are subjected is sorting, in order that each branch of the manufacture may have its appropriate material, after which they are cut with shears into pieces of about one decimeter, or three or four inches square.

I will suppose that the object of the manufacturer is to obtain paper of a beautiful white. If it is intended to be thin, so that,

that, for example, a ream of the size denominated *raisin* should weigh only four or five kilograms, that is to say, about one-third of the weight of common paper of the same form. The manufacturer makes choice either of new rags already of a fine white, or of unbleached rags.

In the case of the white rags, it is sufficient to pass them under the first cylinder, then to give them a bath of the bleaching liquor, and afterwards a bath of sulphuric acid, as we shall proceed to direct, after which they are passed under the finishing cylinder for seven or eight hours, and, lastly, conveyed to the working trough to be made into sheets of paper.

Rags, which have never been bleached, may be treated by either of the following processes, that is to say, the first, which preserves the utmost degree of toughness to the paper, but is likewise the most expensive, consists in decomposing the rag, and afterwards applying the method of Citizen Berthollet for bleaching piece goods; namely, subjecting it to three or four lixiviations, and afterwards alternately to lixiviations, baths of the bleaching liquor, and baths of sulphuric acid. The weight of the raw unbleached material is diminished from 50 to 45 per cent. in these operations.

This method was the first which we used for the assignat paper; but we soon perceived that we might omit most of the lixiviations and baths of the bleaching fluid, and still preserve as much toughness as the paper required. Nothing further was necessary for this purpose than to suffer the rag to undergo a degree of fermentation more or less advanced, by leaving it to rot. In this operation the colouring matter undergoes a slow combustion, and passes to a kind of saponaceous state, and is carried off by the water, by washing the rags in the vessel of the first cylinder.

One single lixiviation, two baths of the bleaching liquor, and one of sulphuric acid, are then sufficient to bleach completely the raw rags or cordage. This is the second method. We were not, at that time, acquainted with the economical process of Citizen Chaptal in the operations of lixiviation. This will, no doubt, be used; but the effect of rotting, carefully conducted, will always be found very advantageous.

Lastly,

Lastly, if the rags be neither perfectly white nor raw and unbleached, but in a medium state, that they are left to rot for a shorter time, for example, twelve or fourteen days, and are taken up when the heat of the fermentation raises the thermometer to 30 or 35 degrees, after which the process is to be conducted as before mentioned.

Composition of a bath of the bleaching liquor, for a pile of decomposed rags, weighing 50 kilograms.

Application and proportions of materials in the actual work.

For each heap of rags a certain number, for example, eight or nine, wooden tubs are disposed in a line, capable of containing in the whole 600 litres of water: 450 litres of pure water is poured in, and 90 litres of bleaching liquor are added in equal portions to each of the vessels, after which the 50 kilograms of decomposed rags are disposed in equal portions in each tub. The stuff is left for about twelve hours in this bath, agitating it from time to time, after which it is to be completely washed in clean water, and put into a bath of sulphuric acid, composed of water 200 litres, and acid at 50 degrees three kilograms, which bath will then have the strength of about four degrees of the barometër of Baumé.

The immersion in the bath must continue for three quarters of an hour or an hour, after which the materials must be well washed in clear water, and carried to the mill to be manufactured.

If the action of the baths of bleaching liquor be not exhausted by the immersion of the decomposed rags (which may be ascertained by the solution of indigo), it may be applied to other materials of the same kind.

Improvements.

Such was the state in which we left this new art in the year 3. Since that time Citizen Welter, to whom chemistry and the arts are indebted for a number of ingenious processes, has simplified that of preparing the bleaching liquor. He has found, for example, that instead of the three vessels of the receiver, it is sufficient to employ two even for the simple liquor that contains no fixed alkali.

Rife of the liquor without alkali.

It was before seen that we were obliged to employ an alkaline solution in the receiver, to prevent that odour which the simple liquor emits when paper stuff is agitated in the baths. The use of alkali answered our purpose very well in this respect;

fect; but this expenditure, besides weakening the bleaching liquor, nearly doubled our expence. Though this difference in the price was of little consequence with regard to the object we then had in view, it is not so with regard to the common operation upon paper intended for sale. Every means of economy must then be used. Now Citizen Welter found that it is easy to obviate the inconvenience of the simple liquor in the operation. His method consists in no longer agitating the goods or material in an open bath, but to close it exactly by means of a cover; and he agitates it by means of cross pieces attached to a handle turned on the outside.

A rough estimate of the price of the simple bleaching liquor prepared by the sulphuric acid, this being the most economical process. Estimate of charges.

The receiver is supposed to contain 1000 litres of water.

25 kilograms of oxide of manganese cost at most	-	-	-	15fr.	0c.
70 kilograms of muriate of soda	-			7fr.	0c.
25 kilograms of sulphuric acid, at 50 deg.				37fr.	50c.
Three days work, principal men	-			9fr.	0c.
Three days —, assistant or labourer				4fr.	50c.
Fuel, about	-	-	-	3fr.	
Wear and tear	-	-	-	6fr.	
Our apparatus cost 622 franks, and the carriage and fixing increased our expence to 1000 franks, the interest of which, at 10 per cent. is 100 franks; and if the work be repeated so many times in the year, the interest per operation will be	-	-	-	1fr.	
					83fr.

Hence the litre of bleaching liquor will cost nearly 9 cents in round numbers. *

* As the price of all these several items in France must materially differ from the same in England, I have thought it unnecessary to reduce the numbers.

Estimate

Estimate of the increase of expence occasioned in the operation upon a pile of 50 kilograms of the paste of paper, supposing one bath of the bleaching liquor and one of sulphuric acid, which is most commonly the case.

Ninety litres of the bleaching liquor at nine cents.	9c.
	8fr. 10c.
Three kilograms of sulphuric acid, at	
1fr. 50c.	4fr. 50c.
Workmanship	50c.
	<hr/>
Total	13fr. 10c.

Which gives for each kilogram of paper an expence of 0,262 franks, or about 27 cents. Now the common paper in the market usually sells for about 1 fr. 30c. or 1fr. 40c. the kilogram, and with the simple augmentation of 27 cents for the operations of bleaching, it obtains the preference beyond that which is sold for three, four, or even five franks, which can only be obtained in limited quantity, on account of the selection of rags. The foregoing methods must therefore produce a great diminution in the price of fine paper. They are more particularly advantageous when applied to the manufacture of thin paper, because the expences of bleaching are always proportioned to the weight of the material, and consequently are least upon thin paper.

Distilling apparatus of *Athenas*.

I shall conclude this memoir with a description of an apparatus, invented by Citizen Athenas, for preparing the oxygenated muriatic acid. He had the complaisance to lend it to us. This apparatus is remarkable for its simplicity, as it requires no vessels of earth or glass, nor intermediate vessels, nor tubes of communication.

Fig. 4, Plate VII. represents the horizontal section, and Fig. 5 the vertical section. The description of this last will be sufficient to explain the construction.

9 represents the ash-hole.

10 the fire-place, having its chimney turned on one side.

11. An iron boiler, containing water kept at the heat of ebullition, serving as a bath for the cucurbit, and effecting the disengagement of the gas.

12. The distilling vessel of lead, in which the subject matters of the operation are put.

13. A vessel lined with lead, intersected by the vessel 12, with which it is foldered.

14. A cock to draw off the fluid when prepared.

15. A receiver of lead inverted in the tub. A hole, 16, may be made in this receiver to let out the atmospheric air when it is plunged in the tub, which hole must be closed before the disengagement of the gas begins. The inverted receiver bears upon three projections of wood, which keep it at a little distance above the bottom of the tub.

When the strength of the liquor obtained by this apparatus was compared with ours, it was found that with equal proportions of materials and of water its discolouring action upon indigo was no more than about the half of ours. Consequently there is a real loss in the consumption of these articles. This must be attributed to the low degree of heat, which does not expel the whole of the gas. I have nevertheless judged that it would be of use to describe this ingenious mechanism, the simplicity of which will, no doubt, give satisfaction to artists. It is obviously capable of improvement, either by placing on one side a separate furnace, with a sand and ordinary distilling vessel, whence the gas may be conducted beneath the receiver by a leaden tube; or, according to the actual disposition of the apparatus, a liquid or dry bath may be substituted to that of water, so as to communicate a higher degree of heat, provided the temperature be less than will melt lead, a condition which admits the desired extrication of the gas.

This last apparatus was less effective than the former.

But it may be improved by raising the heat, and is very simple.

IX.

On the Sound produced by a Current of Hydrogen Gas passing through a Tube. With a Letter from Dr. HIGGINS, respecting the Time of its Discovery.*

INTO a glass bottle is put sulphuric acid and iron filings, through the cork of which a glass tube is passed; the upper extremity is capillary: then by setting fire to the hydrogen gas which escapes by this extremity, a continued current or jet

The flame of hydrogen passing through a capillary aperture, under a tube,

* Bulletin des Sciences, No. 56, An. 10:

of flame is produced, which is let pass into a tube of either glass, metal, earth, or any other substance; when the following phenomena are observed.

produces clear
sounds.

If the tube be not too large, the flame becomes smaller as it is depressed, and when it is much reduced, the tube emits very clear sounds.

But if the tube be too narrow, the flame will be extinguished, and in proportion as the tube is larger, the sound diminishes; so that there is a certain limit at which it totally ceases, which also happens when the tube is too long.

The sounds may be varied at pleasure, by either using tubes of different figures and dimensions, or made of various substances.

This experiment
made in Italy;

These experiments have been made in Italy. Citizen Brugnatelli had described them in his Annals of Chemistry; and he has repeated them with Citizen Volta in the cabinet of the Polytechnic School, in the presence of several persons.

LETTER from Dr. HIGGINS.

To Mr. NICHOLSON.

DEAR SIR,

but was made 25
years ago by Dr.
Higgins.

IT was in the year 1777, that I first exhibited the experiment you mention, and produced several sweet tones, according to the width, length, and thickness of the glass jar or sealed tube, held by the bottom, inverted to some depth over the flame of hydrogen gas. This experiment was afterwards shewn by some of my pupils, to amuse their friends, and particularly by my cousin, Mr. Higgins, who now teaches in Dublin; who exhibited it at Sir Joseph Banks's, and, if I am not misinformed, at Oxford, where he served the professor as operator.*

History of the
discovery.

These tones first occurred unexpectedly, whilst I was making this easy and popular experiment, to shew the water formed during the slow combustion of the slender stream of hydrogen gas in the air of the jar. And as I always had a

* I remember the experiment at Mr. Kirwan's, in 1784, which led me to request the information here given.

great

great variety of such jars on the table, many different tones were produced on the very first day, by applying jars of different capacity and thickness.

I am, SIR,

Your's respectfully,

B. HIGGINS.

Percy Hotel, Jan. 12, 1802.

The cause of the curious phenomenon here described seems difficult to be clearly ascertained. As it is universally admitted that sound is caused by undulations, that is to say, alternate condensations and rarefactions of the air, or some more subtle fluid, we are naturally led to an intensification and remission of the flame of the hydrogen. It is probable that all flame undulates. The flame of a candle is said to dance when this effect is most remarkably evident. I suppose the supply of oily vapor enlarges the flame, until its surface becomes so extensive, as to absorb oxygen in greater quantity than the fuel can be supplied to keep up a combustion of that size: it therefore becomes less, until by the diminution of surface, the due proportion of oily vapor, compared with the oxygen, again exceeds. And in this way we may form a notion of perpetual undulations of size. If these changes were rapid and strong enough, the air would be struck by them into sonorous undulations. In the same manner perhaps we may account for the loud chirping noise I have observed to be produced by the inflamed drops of tallow which fall from a candle held nearly upside down at five or six feet from the ground.

Speculation on its cause.

Cause why the flame of a candle dances.

A chirping noise produced by flame.

W. N.

X.

Description of the Graphometer, or Instrument of CIT. CARANGEAU, for measuring the Angles of Crystals.—From the Mineralogie of CIT. HAUY.*

Structure of the graphometer.

Two concentric, equal quadrantal arcs joined by an hinge; to which are applied compass legs or radii, capable of being shortened to apply to small crystals, &c.

IN order to determine the mutual inclination of the faces of a crystal, or its prominent angles, an instrument is employed, for the invention of which we are indebted to Citizen Carangeau. This instrument, which considerably resembles the graphometer, consists of a semicircle *M T N*, (Pl. VIII. fig. 1.) of brass or silver, divided into degrees, to which two indexes, *A B*. and *F G*, are applied, the one of which, *F G*, is hollowed out from *u* to *R*, from face to face, except at the place *K*, where a small portion is left for the purpose of giving greater strength to the instrument. This index is attached at *R* and *c* to a brass piece or rule situated behind, and forming the same piece with the limb. The connection of the index with this rule is effected by means of two small milled-headscrews, inserted in the groove. The other index, *A B*, is hollowed out in the same manner from *x* to *c*, where it is attached above the former, by means of the screw at the center, which traverses the two grooves. By loosening the screws, we may shorten at pleasure the parts *c G* and *c B* of the two indexes, accordingly as circumstances may require.

The index *A B* having only one point of attachment at *c*, at the center of the circle, moves round this circle, whilst the index *G F* remains constantly in the direction of the diameter, which passes through the points zero and 180 degrees.

It may be proper to remark, that the upper part of the index *A B* ought to be sloped to an edge, on its side *s z*, the direction of which edge, if prolonged, would pass through the center *c* of the instrument. The reason is, that this side is the fiducial edge; that is to say, it indicates upon the graduated circumference the dimensions of the angle we wish to measure.

Mode of operation.

Let us now suppose that we are desirous of measuring in any crystal, the angle which two contiguous planes form with

* This ingenious instrument has been in use a considerable time, and deserves to be more generally known. W. N.

each

each other. It is known that this angle is equal to that of two lines drawn to any single point of the edge which unites these planes, provided they be perpendicular with this edge, and situated in the planes themselves. To find this angle, we dispose the instrument in such a manner, that the portions $c G$ and $c B$ of the two indexes shall have no space between themselves and the points in question, and that their sides shall be perpendicular to the edge at which they join. In this case, the faces which embrace the crystal are tangents to the two planes whose incidence we wish to measure. This being done, we look on the circumference of the instrument for the degree marked by the fiducial edge $s z$, or the angle which this line forms with that which passes through the center c and the point zero, which angle is equal to that formed by the two portions $G c$ and $c B$ of the indexes, because vertically opposite.

It is an advantage to be able to shorten these parts at pleasure, in order to avoid the obstacles which would otherwise render the operation impracticable, either from the gangue to which the crystal adheres, or from the contiguous crystals by which it is partly surrounded.

Advantage of shortening the legs.

Cases, however, occur in which this expedient would not be sufficient, and we should find ourselves embarrassed by the part of the semicircle situated towards M , if its position were invariable. The ingenious inventor of the instrument has guarded against this inconvenience by means of the following mechanism:

In some crystals this expedient is not sufficient;

The screw situated at c holds not only the two indexes, but also a steel radius placed below the brass arm, upon which the index $G F$ is immediately applied. The upper extremity of this radius, or that which is situated towards O , has an excavation into which a brass stem enters, which is likewise provided with a screw. The semicircle is besides divided into two pieces, at the place of the 90th degree; so that, by means of a hinge at that part, the quadrant $T M$ may be folded behind the quadrant $T N$, and is, as it were, suppressed. When we wish to perform this movement, we loosen the screw which supported the upper part of the radius $c O$, disengage the excavation which terminates this radius from the screw which was inserted into it, and draw back the radius till it lies beneath the brass arm which supports the index $G F$.

but part of the circular limb must be occasionally removed.

When

When the angle which we measure exceeds 90 degrees, we return the quadrantal arc *TM* to its former situation, in order to ascertain its dimensions.

The precise measure of angles completes the description of a crystal.

The utility of the goniometer will be very apparent to every one who considers how interesting it is in descriptions of crystals, to know the angles which their faces form with each other. These indications render the description appropriate, by distinctive and truly characteristic traits: without them it can be nothing more than a rude and imperfect sketch, that may apply to a variety of different objects.

Without this they cannot be distinguished.

Thus we do not give a determinate notion of the dodecahedral zircon, when we merely say that it is a prism of four sides, terminated by summits with four rhombuses attached to the longitudinal edges. This description applies equally to the Harmotome (cruciform hyacinth) to the stilbite, to oxidized tin, &c.; but if we add, that the sides form right angles with each other, and that the faces of the summit are inclined towards each other in an angle of $124^{\circ} 12'$, we confine the description to the zircon. If we say that the inclination is $121^{\circ} 57'$, we describe the harmotome; if we say that there are two different inclinations, the one of $123^{\circ} 32'$, and the other of $112^{\circ} 14'$, we describe the stilbite.

Instances.

Other cases,

And still farther: Several varieties of the same substance may present similar forms, differing only in the measures of their angles. Such are, on the one hand, the six rhomboides, and on the other the two decahedrons with rhombic faces, which are found in the carbonates of lime. How shall we describe with accuracy all those varieties, which differ only in the more or less, unless we give the differences with precision? There are even cases in which the use of the goniometer is the only means of avoiding an error, which otherwise would not fail to insinuate itself into the description. Thus the calcareous rhomboid, the angles of which differ only by about $2^{\circ} 18'$ from the right angle, was at first taken for a cube, and we should have continued to denominate it cubic calcareous spar, if geometrical measurement had not rectified this denomination, which is faulty in two respects, both in itself, and with reference to the theory, which demonstrates that the existence of the cube cannot in this instance be reconciled with any of the symmetric laws of diminution.

XI.

Letter of Professor VOLTA to J. C. DELAMETHRIE, on the Galvanic Phenomena.

SIR,

Paris, 18 Vendemiaire, Year 10.

YOU have requested me to give you an account of the experiments by which I demonstrate, in a convincing manner, what I have always maintained, namely, that the pretended agent; or *galvanic fluid*, is nothing but common electrical *fluid*, and that this fluid is incited and moved by the simple *mutual contact of different conductors*, particularly the metallic; shewing that two metals of different kinds, connected together, produce already a small quantity of true electricity, the force and kind of which I have determined; that the effects of my new apparatus (which might be termed electromotors), whether consisting of a pile, or in a row of glasses, which have so much excited the attention of philosophers, chemists, and physicians; that these so powerful and marvellous effects are absolutely no more than the sum total of the effects of a series of several similar metallic couples or pairs; and that the chemical phenomena themselves, which are obtained by them, of the decomposition of water and other liquids, the oxidation of metals, &c. are secondary effects; effects, I mean, of this electricity, of this continual current of electrical fluid, which, by the above-mentioned action of the connected metals, establishes itself as soon as we form a communication between the two extremities of the apparatus, by means of a conducting bow; and when once established, maintains itself, and continues as long as the circuit remains interrupted. You have requested this sketch from me, to be inserted in the next number of your *Journal de Physique*, convinced in your own mind of the truth of these observations by some of the experiments, which I had the pleasure of shewing you yesterday with my small portable apparatus, in presence of the celebrated philosopher of Geneva, M. Piçet, and some other friends. I regret that I have not sufficient time to enlarge the essay which I send you, so as in some measure to comply with your invitation, and which can answer your expectations only in a partial manner. Accept it then as the precursor of a more ample memoir, which I intend shortly to publish.

General outline of the doctrine of the author respecting galvanism.

That the electrical effects are the primary causes of the oxidation, &c. &c.

Narrative of experiments,

I began by shewing you, by means of experiments, delicate indeed but yet simple, that phenomena unequivocally electrical are produced by the mere contact of two different metals, without the intervention of any wet substance—experiments which ought to be considered as fundamental.

Electrometer and condensers.

In order to render this electricity (which is so feeble that without other artifices it would remain imperceptible) sensible and manifest, I employ my electrometers with fine straws, combined with my condensers, the best of which are those made with two metallic discs, which apply very exactly to each other by their faces, which are very flat, and covered with a slight layer of sealing wax, or, which is better, of good lac varnish.

Insulated discs of copper and zinc are applied together.

The first method of performing this experiment was to take two other discs or plates, the one of copper and the other of zinc; to hold each by an insulating handle (of glass covered with sealing wax); to apply them for an instant to each other by their flat faces, and afterwards separating them dextrously, to bring them into contact with the electrometer, which then indicated, by the divergence of its straws, to the distance of about a line from each other, the electricity which each of the plates had acquired, and whether the electricity was positive (or el. +) in the zinc, and negative (or el. -) in the copper, as could be shewn by approaching a stick of sealing wax, that had been rubbed, to the same electrometer.

On the separation, the zinc was el. +, and the copper el. -.

These plates not only move the electricity, but condense it.

It is proper to observe in this experiment, that the two plates, at the same time that they are *motors of electricity* by virtue of their mutual contact, as different metals, perform also the function of condensers, because they are presented the one to the other by a large surface, in consequence of which their contrary electricities are counterbalanced in the best possible manner. This is the reason why this positive electricity in the plate of zinc, and negative in that of copper, which otherwise would not rise to more than about a sixteenth of a degree, and which in fact does not rise higher as long as these same plates remain applied the one to the other, elevates itself, on detaching them, to 1, $1\frac{1}{2}$, or 2 degrees, and even more.

To increase the electric tension, the discs, when separated, are

This degree of electricity may appear trifling; it does not satisfy some persons, who always wish to see effects exemplified upon a large scale. Be it so. In order to obtain electrical

cal phenomena much more distinctly marked, I generally employ a second condenser, mounted upon the electrometer itself, and proceed in the following manner:—I apply the plates of copper and of zinc to each other, and separate them several times, at each separation bringing one of these insulated plates into contact with the upper disc of the condenser, and the other, also insulated, with the lower disc, which is attached to the electrometer. When this contact has been repeated ten, twelve, or twenty times, the disc of the above-mentioned condenser being raised, the electrometer supports the inferior disc alone, which elevates itself to 10, 12, 15, 20 degrees, &c. &c.

It might be imagined that, independent of the action of the condenser, the extent of contact between the two different metals greatly contributes, as such, to raise the electricity to the degree which we have seen, and that we should obtain a much inferior degree, if they touched each other only by a few points. But I prove the contrary; that is to say, that in the one case, as well as in the other, the electric tension rises, during the contact, to the same point, which is about a sixtieth part of a degree of my electrometers of thin straws, when the metals are zinc and copper, and a little more when they are zinc and silver; which tension requiring a quantity of electric fluid in the plate which performs the office of condenser, proportionably larger, accordingly as it condenses 60, 150, 200 times, it is evident why we obtain 1, $1\frac{1}{2}$, 2 degrees, &c. &c.

In order to prove that the contact of two metals of little extent, and which even subsists only at some points, displaces the electric fluid in such a manner as to raise the tension in these metals to the same degree; I join a small plate of copper with another of zinc, either similar or dissimilar with respect to figure and size, applying them to each other at a few points only, or at more points, or even folding them together end to end. See Plate VIII, fig. 3.

Holding the piece z of zinc with two fingers, or in any other manner, I make the other, c, of copper, communicate with the superior disc of the condenser, whilst the inferior disc communicates, as it ought, with the ground. A moment afterwards, raising this upper disc into the air, and holding it insulated, it gives me by the electrometer from 2 to 3 degrees

repeatedly applied to another condenser.

The application of the flat surfaces of the zinc and copper does not increase their motive power.

Metals of other forms brought into contact by smaller or minute surfaces.

Manipulation. A single couple of pieces, one of which is held in the hand, and the other applied to the condenser, produces

of

electricity; equal to that of the larger contacts; of negative electricity (el. -), accordingly, as such a condenser condenses from 120 to 180 times. This proves that the electric tension of the above-mentioned plate *c* was about a sixtieth of a degree, or nearly equal to that which the two plates of copper and of zinc acquired in the preceding experiments, when applied to each other by the whole extent of their flat surfaces.

which is reversed by touching with the other metal.

When we reverse the experiment, that is to say, when we cause the plate *z* of zinc to communicate with the condenser, we likewise obtain from two to three degrees, but of positive electricity (el. +.)

If the zinc piece touch a copper condenser while the other piece (of copper) is held in the hand, no effect follows;

However, if the disc of the condenser be copper, and the plate *z* touch it immediately without any intervening substance, we obtain nothing, because the zinc being then in contact, at the two opposite ends, with copper and copper, two equal forces act in opposite directions, and by that means destroy or counterbalance each other.

unless moisture be interposed.

It is therefore necessary that the communication of the plate of zinc *z* with the copper disc of the condenser should be effected by the interposition of a conductor, which should be a simple conductor nearly, an humid conductor, such as a piece of wet card or cloth.

But it is asserted, that the humidity acts merely as a conductor, to prevent the opposite metallic contacts in the pile.

As to the rest, the action which excites and gives motion to the electric fluid does not exert itself, as has been erroneously thought, at the contact of the wet substance with the metal, where it exerts so very small an action, that it may be disregarded in comparison with that which takes place, as all my experiments prove, at the place of contact of different metals with each other. Consequently the true element of my electromotive apparatus, of the pile, of cups, and others that may be constructed according to the same principles, is the simple metallic couple, or pair, composed of two different metals, and not a moist substance applied to a metallic one, or inclosed between two different metals, as most philosophers have pretended. The humid strata employed in these complicated apparatus are applied therefore for no other purpose than to effect a mutual communication between all the metallic pairs, each to each, ranged in such a manner as to impel the electric fluid in one direction, or in order to make them communicate, so that there may be no action in a direction contrary to the others.

After

After having well ascertained the degree of electricity which I obtain from one single pair of these metallic pieces, as shewn by the condenser which I employ, I proceed to shew, that with two, three, four pairs, &c. properly arranged, that is to say, disposed all in the same direction, and communicating the one with the other, by as many humid strata (which are necessary, in order that there may be no contrary actions, as I have already shewn), we have exactly the double, triple, quadruple, &c. so that if with a single pair we should be able to electrify the condenser to that point as to make it indicate, by the electrometer, three degrees, for example, we should obtain six with two, nine with three, twelve with four, &c. if not exactly, yet nearly so. You have seen these experiments, and have appeared to be very well satisfied with them, as well as Mr. Pictet, who seemed enchanted with them, and was never tired with seeing them repeated.

The intensity of a succession of couples is the same multiple of that of a single couple of plates.

Here then we have already constructed a small pile, which however does not yet afford any indications, by the electrometer without the aid of the condenser. In order that it may immediately afford these, in order that it may arrive at one whole degree of electric tension, which it will scarcely be possible to distinguish, because it amounts to no more than half a line on the electrometer, it is necessary that such a pile should be composed of about sixty of these combinations of copper and zinc, or, which is better, of silver and zinc, on account of the sixtieth of a degree which each combination yields, as I have already remarked. It then also affords shocks and gives shocks, if we touch its two extremities with wet fingers, and much stronger shocks if we touch them with metals grasped by large surfaces in the hands well moistened, by which means a much better communication is established.

This is the pile;

and gives shocks.

In this manner we may receive shocks from an apparatus, whether in pile or with cups, of 30 and even of 20 pairs, provided the metals be sufficiently clean, and especially if the humid strata be moistened, not with mere pure water, but with a considerably strong saline solution.

Saline liquids, instead of water, increase the effect;

These saline liquids, however, do not properly augment the electric force;—not at all;—they merely facilitate the passage, and leave a freer course for the electric fluid, being much better conductors than simple water, as several other experiments prove.

but merely, it is asserted, because they are better conductors.

In

Experiment of-
fered in proof.
A series of
glasses, with the
metals and wa-
ter, give a cer-
tain electric in-
tensity and shock;
but on adding
salt to the water,
the intensity is
the same, though
the shock is
much greater.

In order to establish this fact, and render it evident to such as have found a difficulty in admitting it, that the electric force or tension is, if not entirely, yet very nearly the same, whether the wet layers be moistened with pure water or with a saline solution, though the difference in the shock is so great, I have frequently made the following experiments, of which I have spoken to you, and which I would have shewn to you, if I had been provided with the requisite articles. I take 30 cups or drinking glasses, with which I construct one of these apparatuses which I term a crown of cups, putting into them a sufficient quantity of pure water, and causing them to communicate, the first with the second, the second with the third, and so on successively to the last, by means of metallic wires, which terminate at one end in a plate of copper, and at the other in one of zinc, and are all turned in the same direction. The apparatus being constructed in this manner, I try its electric force, by causing the first of the cups to communicate with the ground, and applying the condenser to a piece of metal which is partly immersed in the last: this condenser, when I afterwards withdraw it, and separate one of its discs from the other in the proper manner, and without delay, gives me 40, 60 degrees, and more, according to its condensing force. I also try the shock in the most advantageous manner, and find that it is very slight: after having well ascertained both the degree of the electricity and the weakness of the shock, I add a pinch of salt to each cup, and repeating the proofs, I find that the electricity has not been at all increased, the condenser giving me still only 40 or 60 degrees, as before; but the shocks are incomparably stronger.

The apparatus
charges a large
battery almost
instantaneously.

There are many other experiments, which I have described to you verbally, and which I would willingly have performed before you, had I not been in want of the requisite apparatus. I informed you—at which you were much astonished, and Mr. Pictet still more so—that with one apparatus I charge a Leyden phial, whatever its capacity may be, and even a large battery; that I charge them in an instant, or, to speak more accurately, in less than a twentieth part of a second, and almost to the same degree as the apparatus itself, namely, to about one degree of tension, if the apparatus be composed of 60 pairs; to two degrees if it contain 120, &c.;—that I am then able to draw, by the help of the condenser, a strong spark from

from a small jar charged in this manner, a great number of similar sparks from a large jar, and almost without limit from batteries, as I am actually able to draw them without limit of number from the apparatus itself.

I have informed you, that large bottles charged in this manner gave me moderate shocks, and batteries pretty strong ones, as high as the elbow, and higher; that the shocks of a battery of 10 square feet of coating, and charged in less than a twentieth part of a second by one of my apparatuses of 200 metallic pairs, are very violent and almost insupportable; for I have not yet made any trial with larger batteries; but that there is every probability that the violence of the shocks increases with the size of the batteries, as far as a certain term, which I am not able to define; so that it would be possible, with batteries of 40, 60, and 100 square feet, to give considerably strong shocks, by charging them by the transient contact of a pile only 60, 40, 30, or still fewer pairs.

I have explained to you the manner in which one ought to proceed in order to perform these experiments with success; that it is particularly necessary we should carefully avoid the slightest interruptions in the communications of the conductors with the coatings of the bottles, and between each other, and that this becomes still more necessary when the electromotive apparatus, being composed of a small number of pairs, possesses but little power, so as to be unable to overcome the slightest obstacle that might oppose the passage and the course of the electric fluid.

Lastly, I remarked to you, that these experiments confirm in a very evident manner what all the others already suggested, namely, that the quantity of electric fluid set in motion by my apparatus is much larger for every moment of time than that which is set in motion by the ordinary electrical machines; that the former afford it in much greater abundance than the latter, when the object is to produce, not an accumulation of electric fluid in insulated bodies, in order to raise the electricity to a high degree of tension, which may be done with those machines, but by no means with piles and other similar apparatuses, unless we also employ condensers; but where we require a constant current of this fluid, supported by a continued action of a circle of condensers not insulated; nay, one of my apparatuses, of only 60 or 30 metallic pairs, pours out

Strong shocks from batteries so charged.

Cautions in order to succeed in charging a battery by galvanism.

The pile moves a much greater quantity of electricity than any machine.

in every instant, or in any given time, more electric fluid, if it meets with no obstacle, or if the fluid be not obstructed by the too small capacity of the recipient into which it is infused, than one of the most active electrical machines with cylinders or plates of glass. In fact, where shall we find a machine capable of charging a very large battery to one or even half a degree in less than an eighth part of a second, of pouring into it a sufficient quantity of electric fluid to enable us afterwards to draw from it, by the condenser, a great number of sparks in succession, as is done by one of the above-mentioned apparatuses? *

Mention of other experiments.

The other experiments, which I was able to shew you in part, relate to the different electroscopic phenomena which the apparatus presents, accordingly as the one or the other of its extremities communicates with the ground, or both of them, or neither one nor the other, or as they communicate only between themselves and with the ground at the same time; accordingly as these communications are effected by perfect conductors, conductors more or less imperfect, &c. all which circumstances singularly modify and produce great variations in the results, which often appear curious and even anomalous, but which, nevertheless, I think myself able to explain in a satisfactory manner, without deviating from my principles and sound electrical theory, attention being paid to the mode in which the imperfect or bad conductors act. It would carry me too far to enter at present into these details; what you have already seen, and what I have communicated, may be sufficient for the present occasion.

Observations on the preceding Memoir. W. N.

Theory of Volta too hastily adopted.

Sig. Volta, and many of our philosophical neighbours in France, will, no doubt, think, on re-consideration of the facts, that they have been too precipitate in admitting the electric energy as the only effective agent in the phenomena of the pile, and that the fluids act merely as conductors. The late interruption to correspondence may probably have rendered the contents of my late Journal little known in France, otherwise the learned author of this memoir would

* On this subject see *Philosoph. Journal*, 4to. IV. 243—245. N.

have met a fatal objection to that part of his theory, which gives all to the metals and nothing to the fluids, in * Mr. Davy's galvanic pile with one kind of metal only and three fluids. Davy's galvanic pile, consisting of one metal throughout, but with different strata of fluids: for example thus; metal, cloth soaked in dilute nitrous acid, cloth soaked in water, cloth soaked in sulphuret of potash;—then the same metal, and nitrous acid, and water, and sulphuret;—the metal, &c.

Or if a trough be used, the separation between the acid and sulphuret may be made by a plate of horn, and the two fluids may be connected by a slip of wetted paper hung over the edge of the horn, which will not cause the fluids to mix, because water is lighter than either. The metals, separately and successfully tried, were silver, copper, zinc, and lead. Trough of the same construction.

To this I will here add, from conversation, an experiment of the same philosopher, which is no less conclusive as to the direct efficacy of the fluid in this apparatus; because the same electric power is made to move either from the top or bottom of a pile of two metals, according to the nature of the interposed fluid.—If a pile of copper and iron be constructed as usual, with water interposed, the iron becomes electrified *plus* and the copper *minus*; but if the same, or a similar pile, be constructed with no other difference than that sulphuret of potash is used instead of water, the iron is electrified *minus* and the copper *plus*. In the first case the iron is oxidized; but in the second there is no oxidation of this metal, and the copper is oxidized, and probably sulphurated. Electric current of the common pile reversed by changing the fluid.

Lastly, we have another instance of the power and importance of the fluids in the article which follows the present, where charcoal alone is used, and the leading condition is, that two different fluids shall be used. Galvanic series of charcoal only and two fluids.

As we know by the experiments of De Saussure, and many others, that chemical changes do disturb the equilibrium of electricity, and they certainly take place in the pile, it seems at least probable that these may have the chief agency in the apparatus. With regard to the principle of electric motors of Sig. Volta, I must observe, that Bennet made many direct experiments of applying different metals, by the single Chemical changes are known to produce electricity; and as such changes happen in the pile, they may probably cause its electricity.

* See notice in the Scientific News, Phil. Journal, 4to. for May, 1801, Vol. V. p. 78; and the subject is fully treated in the Philos. Transf. for 1801, in a paper inserted in the same volume of our Journal, 4to. p. 341.

and

Bennet made experiments on electricity by contact of metals before A. D. 1789.—Cavallo before 1795. and double touch, to the plates of the doubler, followed by the production of electricity, by him called adhesive electricity, which were published in his *New Experiments on Electricity* in 1789, pages 86 to 102; and others were made by Cavallo on the electricity produced by the contact or stroke of a piece of metal, let fall out of the hand, for the most part, upon an insulated metallic plate, which were published in the third volume of his *Electricity* in 1795. I do not know the date of Volta's experiments, but believe them to be much later than those of the same kind by Bennet. This last philosopher, as well as Cavallo, appears to think that different bodies have different attractions or capacities for electricity; but the singular hypothesis of electromotion, or a perpetual current of electricity being produced, by the contact of two different metals is, I apprehend, peculiar to Volta.

They supposed various electric capacities; but the hypothesis of a current of electricity produced by metallic contacts belongs to Volta.

XII.

An Account of a Method of Constructing Simple and Compound Galvanic Combinations, without the Use of Metallic Substances, by means of Charcoal and different Fluids. By Mr. DAVY.

- Charcoal between nitric acid and water affords galvanic effect.**
1. **I**F a piece of well burned charcoal be brought in contact at one of its surfaces with a portion of water, and at another surface with a portion of nitric acid, a simple galvanic combination will be formed when the two fluids are connected together. And the powers of it are demonstrated by its agency upon the limbs of frogs, and by its effects upon the organs of sense.
- Series of such combinations.**
2. A compound galvanic combination or a galvanic battery may be formed from a number of series composed of the same substances: but in this case the fluid elements of each series, not being immediately in contact, must be connected with similar elements in other series in an order of regular alternation, such as water, charcoal, acid; water, charcoal, acid; and so on.
- Charcoal battery by a series of glasses alternately charged with nitric acid and water, and al-**
3. The best mode that has yet occurred of constructing galvanic batteries with charcoal, is by means of a number of glasses, which are made to contain, alternately, nitrous acid, and water, and which are connected in pairs by means of moistened

tened cloth. The pieces of charcoal used are made from very dense wood, such as box, or lignum vitæ; and in this case the fluids will not penetrate into them by capillary attraction, much beyond the places of their primary contact. Their forms are those of arcs, so that each piece connects together two glasses; but in instances where single pieces of charcoal cannot be obtained of the proper shape, two long and thin slips may be fastened together by silk, so as to form the angle necessary to their insertion into the glasses.

4. Twenty series in a battery of this kind produce sensible but feeble shocks, and when a single metallic series with a gold wire and two glasses of water is substituted for one of the primary series, hydrogen is given out by the metallic point in the glass of water in the place of the acid, whilst oxygen is evolved from the point in the other glass.

5. In the galvanic batteries with charcoal, sulphuric acid may be substituted for nitric acid; and solution of sulphuret of potash for the water, without any material alteration in the nature of the agency; the solution of the sulphuret indeed, seems, in some measure, to increase its intensity, and combinations containing this substance, dense charcoal, and concentrated nitric acid, appear to be superior in activity to similar combinations containing copper and the same fluid elements, and to be nearly equal to those composed of zinc, silver, and water.

January 9, 1802.

XIII.

Short Analysis of the Principles and Structure of Mr. Close's Hydraulic Engine.—W. N.

AN eminent engineer, to whose talents and invention society is highly indebted, writes to me that he cannot understand Mr. Close's engines, and requests some explanation, as he does not conceive that impossibilities would have my sanction. Though I am convinced that an attentive revival of the descriptions would render my elucidation unnecessary, yet as that which he requests may not be unacceptable to other readers, I have here annexed a few observations; viz.

An explanation of Mr. Close's engines requested.

Short enumeration of its principles and mode of operation.

1. That the water (of which part is intended to be raised above the level) must have a fall. 2. That this fall affords the usual difference between the legs of the syphon. 3. That if the syphon had two or more ascending legs, water would rise through them all. 4. That if one of these legs were small and contained air, that air would pass into the great syphon, and if the velocity of the fluid were rapid enough, the bubbles would pass down along with the water, instead of rising to the top and breaking the column. 5. That if there were a contrivance of two cocks in the water way of the small ascending leg, and both were shut, the portion of water might be drawn out from between them by a side cock, and that space filled with air. 6. That this space may, if thought fit, be a globe or other vessel. 7. That this space being above the level, the water thus drawn off is *in fact raised*. 8. That by shutting the side cock, and opening the two others, the included air would ascend and be carried down the great syphon. 9. After which another like portion of water might be drawn out as before, &c. &c. And, 10. It is clear that by small syphon work the cocks might be opened and shut without attendance.

The water is raised as usual by its fall.

Utility of publishing new inventions.

This is only one of the many methods of raising water above its level by virtue of its fall. It certainly possesses merit and originality of invention; but whether it be generally preferable to other known methods is another question. For my part, I think it is of advantage to our general stock of knowledge and invention, to publish all ingenious novelties, without any particular solicitude respecting the extent of their power. A variety of circumstances and local situations afford opportunities of applying engines, or their parts, with singular advantage, which in the general contemplation of their structure and use, might seem to be more striking for their singularity than their effect.

XIV.

Simple Process for taking a Copy of a recent Manuscript. Communicated to the Philomathic Society at Paris by CHARLES COQUEBERT.

THIS process is the more interesting as it requires neither machine nor preparation; and may be used in any situation. It consists in putting a little sugar in common writing ink, and with this the writing is made on common paper sized as usual, when a copy is required; this unsized paper is taken and lightly moistened with a sponge. The wet paper is then applied to the writing, and a flat iron, such as is used by laundresses, of a moderate heat, being lightly passed over the unsized paper, the counter-proof or copy is immediately produced*.

Sugar is put in the ink. Damp unsized paper is laid on the writing. The impression or copy is made by an heated iron.

XV.

Narrative and Explanation of the Appearance of Phantoms and other Figures in the Exhibition of the Phantasmagoria. With Remarks on the Philosophical Use of common Occurrences.—
W. N.

A VERY striking application of the magic lanthorn has been made this winter to the public amusement by M. Philipsthal at the Lyceum. The novelty consists in placing the lanthorn on the opposite side of the screen which receives the images, instead of on the same side as the spectator, and suffering no light to appear but what passes through, and tends to form those images. His sliders are therefore perfectly opaque, except that portion upon which the transparent figures are drawn, and the exhibition is thus conducted.

Phantasmagoria. New application of the magic lanthorn by placing it on the opposite side of the screen, and making the figures alone transparent.

* I have not heard who was the original inventor of this useful process. That sugar prevents ink from speedily drying has been long known, and this method of impression has been used in some of our public offices, and elsewhere in England for some years.

W. N.

Account of the
exhibition of
Mr. Philipsthal.

All the lights of the small theatre of exhibition were removed, except one hanging lamp, which could be drawn up so that its flame should be perfectly enveloped in a cylindrical chimney, or opaque shade. In this gloomy and wavering light the curtain was drawn up, and presented to the spectator a cave or place exhibiting skeletons, and other figures of terror, in relief, and painted on the sides or walls. After a short interval the lamp was drawn up, and the audience were in total darkness, succeeded by thunder and lightning; which last appearance was formed by the magic lanthorn upon a thin cloth or screen, let down after the disappearance of the light, and consequently unknown to most of the spectators. These appearances were followed by figures of departed men, ghosts, skeletons, transmutations, &c. produced on the screen by the magic lanthorn on the other side, and moving their eyes, mouth, &c. by the well known contrivance of two or more sliders. The transformations are effected by moving the adjusting tube of the lanthorn out of focus, and changing the slider during the moment of the confused appearance.

Darkness.
Thunder.
Lightning.

Figures of the
departed; phan-
toms, &c.

The figures
seem to recede
to an immense
distance.

It must be again remarked, that these figures appear without any surrounding circle of illumination, and that the spectators, having no previous view or knowledge of the screen, nor any visible object of comparison, are each left to imagine the distance according to their respective fancy. After a very short time of exhibiting the first figure, it was seen to contract gradually in all its dimensions, until it became extremely small and then vanished. This effect, as may easily be imagined, is produced by bringing the lanthorn nearer and nearer the screen, taking care at the same time to preserve the distinctness, and at last closing the aperture altogether: and the process being (except as to brightness) exactly the same as happens when visible objects become more remote, the mind is irresistably led to consider the figures as if they were receding to an immense distance.

How effected.

Transforma-
tions.

Several figures of celebrated men were thus exhibited with some transformations; such as the head of Dr. Franklin being converted into a skull, and these were succeeded by phantoms, skeletons, and various terrific figures, which instead of seeming to recede and then vanish, were (by enlargement) made suddenly to advance; to the surprize and astonishment of the audience, and then disappear by seeming to sink into the ground.

Skeletons, &c.
suddenly rush
forward.

This

This part of the exhibition, which by the agitation of the spectators appeared to be much the most impressive, had less effect with me than the receding of the figures; doubtless because it was more easy for me to imagine the screen to be withdrawn than brought forward. But among the young people who were with me the judgments were various. Some thought they could have touched the figures, others had a different notion of their distance, and a few apprehended that they had not advanced beyond the first row of the audience.

The deceptions not equally effectual to all the spectators.

As I have given this account, of an exhibition on which an ingenious mechanic in part depends for his support, it will not be impertinent to my present and future readers to add, that the whole, as well as certain mechanical inventions, were managed with dexterity and address, and that his gains in London have been very considerable. The figures for the most part are but poorly drawn, and the attempt to explain the rational object, or purpose of the exhibition was certainly well intended; but unfortunately for the audience his English was unintelligible. His lightning too, being produced by the camera was tame, and had not the brisk transient appearance of the lightning at the theatres, which is produced by rozin, or lycopodium powder, thrown through a light, which in Mr. P's utter darkness might easily have been concealed in a kind of dark lanthorn.

Observations on the performance.

Lightning.

My young pupils on their return made drawings, and applied the magic lanthorn to a sheet in a door way between two rooms. Some of their drawings were made on thin paper and varnished, to render them transparent, and others were on glass. The paper figures were less bright than the others; but an advantage may be had in this material by those who cannot draw, because they may colour and varnish small figures, engraved in aqua-tinta or in any other manner without stroke.

Imitation by some young persons.

A plate of thin sheet iron, such as German stoves are made of, is an excellent instrument for producing the noise of thunder. It may be three or four feet long, and the usual width. When this plate is held between the finger and thumb by one corner, and suffered to hang at liberty, if the hand be then moved or shaken horizontally, so as to agitate the corner at right angles to the surface, a great variety of sounds will be produced; from the low rumbling swell of distant thunder, to the succession of loud explosive bursts of thunder from elevated clouds,

Remarkable imitation of thunder by a sheet of iron.

clouds. This simple instrument is very manageable, so that the operator soon feels his power of producing whatever character of sound he may desire; and notwithstanding this description may seem extravagant, whoever tries it for the first time will be surprized at the resemblance. If the plate be too small, the sound will be short, acute, and metallic.

To Correspondents.

Ludicrous Essay.

Our best philosophers have profited most from common occurrences.

Ridicule not injurious to the progress of philosophy.

The present seems to be no unfit place to notice some correspondents which my late paper on shaving has induced to favour me with a few letters. To those who find themselves instructed and gratified by a small addition to their daily comforts, I can only give my congratulation; but to that friend who calls himself *a Shaver*, but who I fear is no true shaver, from the little veneration he seems to have for the art, I am to return my thanks for his *Essay on the Art of cutting Bread and Butter*, and must say, that if it had abounded with instruction equal to its merriment, I should have been glad to have given it to my readers. He who shall invent a machine to perform even this operation, will, I think, deserve well of society. I would humbly propose it as my opinion, not without expectation that many others may think with me, that no subject is beneath the consideration of a philosopher. Our best philosophers have been most studious of the daily occurrences of life. Newton's attention was attracted by the fall of an apple before he extended the theory of gravitation to the moon. Soap bubbles and the prism were play-things before he selected them as instruments to analyse the rays of light. Franklin by the kite of a child conducted lightning from the clouds to the earth; and in a word, it appears that the greatest discoveries have been made, not by those who could command the expensive and ornamental apparatus of showy experiment, but by such as were in the habit of close attention to the means, the agents, and the operations which are constantly performed around us, and frequently ill understood because habitually neglected.

But laughter is said to be one of the distinctive characters of the human species, and our pleasures are not so many that we should reject any innocent source of amusement. No serious evil is to be apprehended from raillery, especially if at-

tended

tended with good nature. Herschel will not be diverted from pursuing his discoveries, because the inhabitants of Laputa give themselves too much anxiety about the sun's good health. Let the man of wit enjoy his joke, and the man of experiment his rational toys, provided both unite in cultivating that amiable spirit of philanthropy, on which the happiness of social intercourse so much depends.

SCIENTIFIC NEWS.

Extract of a Letter from Dr. LORENZ DE CRELL. (*Helmstadt*, Dec. 14, 1801.) On the Chlorophane and a supposed Variety of Barytes.

THE Prince of Gallitzin, F.R.S. possessor of a most excellent mineralogical cabinet, and living now as a private individual at Brunswick, has observed that the chlorophane, or that Siberian fluss-spar, which, after being gently heated on charcoal, turns green (on account of which it is called pyromaragdus in the *Chemische Annalen*) and on being cooled regains its former colour; that the chlorophane, I say, loses this property on being exposed in a tin box to the rays of the sun in a window during the summer. It was turned quite colourless, and exhibited no light at all on being heated.—

The Count of Hoffmansegg, whose travels to Portugal (for discoveries in natural history) were written by Professor Linck, his companion, has brought with him two stones, greatly resembling quartz, or rock crystal externally, but without regular figure; giving sparks with steel, but of far greater specific gravity, viz. 3,500. It shewed some electricity on friction. This new kind of stone (for such it is thought by good mineralogists) is to be analysed chemically. In the mean time Dr. Bruckman, who is well known by his books on precious stones, thinks proper to call it *barytes nobilis*.

Corrindon or Adamantine Spar found near Philadelphia.

M. Guillemard, a learned mineralogist, who has travelled much in North America, writes to Dr. Delam therie, that Mr. Adam Seybert has discovered corrindon or adamantine spar.

Corrindon or adamantine spar found in America.

spar

spar at Chestnut-hill, about ten miles from Philadelphia. It is known that the sea coast in these parts is entirely granitic, and this granite extends to a considerable distance inland. Farther inland succeeds the gneiss; then micaceous schistus; then grit stone; and, lastly, the ground towards the lakes Ontario and Erie is all calcareous.

The granites of the coast of Philadelphia contain various marked veins of granite, as is observed in different granitic soils.

It was in one of these granitic veins, which may be almost compared to loads (filons), that Mr. Seybert found corindon mixed with the other substances or elements of granite which compose the vein,

J. de Phys. Brum. 10.

Nature of the Earth which is eaten by the Inhabitants of New Caledonia, ascertained by CIT. VAUQUELIN.

Savages on the Oronoko eat earth, which is thought to be nourishing.

Humboldt, in a letter to Fourcroy, of which an extract was given in the 50th number of the Bulletin des Sciences, affirms, that the Otomagues almost entirely subsist on a kind of earth for three months, when the Oronoko is so high that they can find no more turtle. Some of them eat a pound and a half daily. It is affirmed by the missionaries that they mix it with the fat of the crocodile's tail; but Mr. H. insists that they do nothing but slightly burn and moisten it. He thinks that moistened earth may be nourishing by decomposing the air, or by some effect of the chemical affinities.

Inhabitants of New Caledonia also eat earth.

Cit. Labillardiere has stated a fact equally singular, from an observation made in a part of the world considerably distant from that inhabited by the Otomagues; that the inhabitants of New Caledonia, when pressed by hunger, eat a considerably large quantity of a greenish steatites, which is soft and friable. It may be easily imagined how the dreadful custom of eating prisoners of war might have been introduced amongst a savage people, who are reduced to such want as to be obliged to satisfy their hunger by distending their stomach and intestines with an earthy substance, which has no other alimentary quality but that of being light and friable.

Cit,

Cit. Vauquelin, wishing to know the nature of this earth, and to discover if it contained any nutritive parts, has analysed it by the usual methods, from some specimens which were sent him by Cit. Labillardiere. This, by analysis, found to contain no nutriment.

This earth is soft to touch, composed of small fibres, which are easily separated, and when ignited it loses $\frac{1}{100}$ of its weight. It is composed of,

37 parts of pure magnesia.

36 of filex.

17 of oxide.

3 or 4 of water.

2 or 3 of lime and copper.

It does not therefore contain any alimentary parts, and can only be considered as filling the stomach; a kind of mechanical expedient to suspend the pains of hunger.

Soc. Philomath. No. 55, An. 10.

Account of a blue Oxide of Iron. By CIT. VAUQUELIN.

This substance was sent to the Counsel of Mines, by the Baron de Molt. It is of a light blue colour, and has the form of small insulated masses in the cavities or clefts of quartz and hard green steatites. It is friable, but rather greasy to touch, and changes its colour before the blow-pipe, and at last melts into a greenish white glass. Blue oxide of iron not yet analysed.

Neither acids or weak alkalis alter its colour. These circumstances distinguish it from lapis lazuli and the prussiate of iron.

This substance communicates a saffron yellow to the muriatic acid in which it was digested, and changes its own colour a little, but cannot be discoloured unless it be at the same time dissolved. There only remains a small quantity of filex, which appears to have constituted its gangue.

On examining the muriatic acid that was used for this operation, it was found it had taken up alumine, lime, and oxide of iron, but neither sulphurated hydrogen, manganese, nor phosphoric acid were discovered in it, substances to which the blue colour of this oxide of iron might be ascribed. It therefore remains to be determined what is the cause of the remarkable colour of this oxide, a colour which has never yet been

been given to this metal by any chemical process. It appears only that the iron in this oxide is carried to a degree of oxygenation nearly approaching to the *maximum*.

Bulletin de Sc. No. 55, An. 10.

Use of Whiskers in certain Quadrupeds. By M. VROLYK,
Professor of Natural History at Amsterdam.

The whiskers of animals appear to be useful to feel their way in irregular cavities.

This naturalist has endeavoured to ascertain, by experiment, of what use the long stiff hairs, termed *whiskers*, which are placed near the mouth of certain quadrupeds, might be to them. Having disposed a number of books, placed on their edges, upon the ground in his chamber, so as to form a kind of labyrinth, he let loose a rabbit, with his eyes bound up, amongst them. The animal succeeded in extricating himself from this labyrinth, without having overturned them; but when Mr. Vrolyk had cut off his whiskers, the animal, having no longer these tentacula to direct him, ran against the books, and overturned them. Moreover it is known that the bulb, in which each of the whiskers is implanted, receives a small nervous filamen proceeding from the infra-orbital nerve.

Soc. Philom. No. 50, X.

Galvanic Charge of a large Battery by the Metallic Pile. By
Dr. VAN MARUM.

The Harlem battery charged by galvanism.

Dr. Van Marum, of Harlem, has charged 25 large electric jars (containing $137\frac{1}{2}$ square feet of coating) by an almost instantaneous contact of a galvanic pile of 200 pair of 3 Guilder silver pieces, alternated with zinc and moist cloth. The electric intensity was equal to that of the pile itself, but the shock much less. The shock of the battery was generally equal to that of half the number of pairs employed in its charge. It was, however, very strong, and reached up to the shoulders. As the 120th Number of the *Annales de Chemie*, in which his letter is inserted, arrived late in the month, I must defer the rest of the account.

ACCOUNT OF BOOKS OF SCIENCE.

A Syllabus of a Course of Lectures on Chemistry, delivered at the Royal Institution of Great Britain. By Mr. Davy. 90 pages, 8vo. Cadell, London.—On Thursdays and Saturdays at two, and on Thursdays at eight o'clock, P.M. The morning lectures are read on general chemistry, and the evening lectures on the connection of chemistry with the arts:

The present course is divided into three parts. Part I. Davy's chemical lectures. The chemistry of ponderable substances; under six divisions. 1. Of the chemical powers, and the modes of their application. 2. Of undecomposed substances, or simple principles. 3. Of bodies composed of two simple substances. 4. Of bodies composed of more than two simple substances. 5. Of substances composed of different compound bodies, or of compound bodies and simple bodies. 6. Of the general phenomena of chemical action. Part II. The chemistry of imponderable substances; under four divisions. 1. Of heat or caloric. 2. Of light. 3. Of the electrical influence. 4. Of galvanism. Part III. The chemistry of the arts; under eight divisions. 1. Of agriculture. 2. Of tanning. 3. Of bleaching. 4. Of dyeing. 5. Of metallurgy. 6. Of the manufactory of glass and porcelain. 7. Of the preparation of food and drink. 8. Of the management of heat and light artificially produced.

It is unnecessary to make any general remarks on the benefits derived to science from correct and sufficiently extensive outlines of facts and doctrines published from time to time by their active cultivators. The present work must prove eminently useful to the pupils of the lecturer, and will add to his reputation by its perspicuity and order. In the rapid progress of experimental discovery, even those learned men who attend to the general state of natural philosophy, without closely following its minuter variations, will be essentially served by clear notices of the present state of one of its chief departments.

The

The Elements of Book-keeping: comprising a System of Merchants' Accounts, founded on real Business, and arranged according to Modern Practice. By P. Kelly, Master of Finsbury Square Academy. Price 5s. Johnson, Robinsons and Rivingtons.

Kelly's Elements of Book-keeping.

The improvements which time and experience have effected of book-keeping, do not comprehend any change in the original principle of double entry; but in the arrangement and classification of similar accounts, which facilitate the operations of commerce nearly in the same manner as the business of manufactures is expedited by the division of labour. The elementary treatise before us exhibits these improvements.

The author introduces his work by a concise account of the history of this art, which he thus concludes: "from the foregoing view of the principal authors who have written on book-keeping, it appears that they have been composed of two different descriptions, possessing very distinct qualifications. The first, and by far the most numerous class, were teachers who have explained the principles, without adverting to the progressive improvements of practice; and the second, merchants who have exhibited those improvements, without explaining the principles. The productions of both classes of writers are highly useful, and to combine their utility is the object of the present undertaking."

This work comprises three sets of books, the first explains and illustrates the principles of both single and double entry; the second is a further exemplification of the Italian method of double entry by waste book, journal, and ledger, which does not differ from the systems given by other authors; but the third set of books differ essentially, and therefore deserves particular notice. Here the waste-book is divided into a number of subsidiary books, each of which is the register of its peculiar portion or department of business, and each book is divided into monthly transactions. By this means the journal is greatly shortened and simplified; but the principal advantage of this systematic arrangement consists in posting to the ledger; for there a whole month's cash, bills, commission, insurance, or interest, are each carried in one sum or entry from the journal to the ledger. This method, by which repetitions are avoided, and labour considerably diminished, is now generally adopted in many principal mercantile houses. The author

informs

informs us in his preface, that "he has had access, for many years, to the books of several eminent merchants; and that he has endeavoured in all cases to follow the most approved precedents of mercantile experience."

In the third set of books the invoices, sales, and other transactions, have been selected from merchants books:—the advantage of founding a system of book-keeping on real occurrences are obvious; for although the principle of double entry can be explained by fictitious examples, yet these may give the learner wrong notions of business; whereas from real transactions, he will obtain so much practical information of commercial affairs in general, as must interest the mind, and more effectually fix the attention in the course of study.

Memoirs sur l'Influence de l'Air, &c.—Memoirs concerning the Influence of the Air, and several gaseous Substances, on the Germination of various Kinds of Grain. By Huber and Senebier, 1 Vol. in 8vo. Geneva. Paschoud, 1801.

This work is curious from the circumstances under which it was composed. Cit. Huber, already well known for his writings on Bees, is blind, notwithstanding which he has performed those experiments which were suggested to him by C. Senebier. The experiments were made in order to determine the influence of various gases, particularly the oxygen gas on germination*. The seeds were placed either on wet flannels or sponges under receivers filled with gas; the principal results were as follows. All the grains placed in the azotic gas remained unaltered, but germinated on being afterwards placed in the open air. Their growth was accelerated, though slightly, in pure oxygen, but was more vigorous in that which contained a little carbonic acid. In this experiment the carbon of the grain combines with the oxygen, and forms carbonic acid gas. The seeds sprung up in artificial atmospheric air, the same as they would have done in common air. The proportions most favourable for germination, are three measures of azote or hydrogen to one of oxygen. The grains which did not grow when included

Huber and Senebier on the influence of air on vegetation.

* On this subject see also Cruickshank, in the Phil. Journal, 4to, Vol. I. page 339, for Nov. 1797.

Huber and Senecier on the influence of air in vegetation:

in azote, were not affected by a proper quantity of oxygen being introduced by degrees, but shot forth very well when the same quantity was introduced at once. This difference may be explained by considering, that in the first case the oxygen is successively employed in receiving from the grain the carbon which is disengaged, so that none remains to vivify it, but when it is poured in at once, there is sufficient for both purposes.

Seeds do not germinate either in carbonic gas, or pure hydrogen gas. One lettuce seed absorbs in order to germinate a portion of oxygen, which is equal to 26 milligrammes of water, (half a grain) and it does not grow unless the oxygen is at least the eighth part of the atmosphere in which it vegetates. A great quantity of carbonic acid gas is more injurious to germination than the azote, and the azotic gas more so than hydrogen.

If seeds be put to grow in hydrogen gas, the carbon of the grains dissolves in it, and combines very intimately.

The vapour of sulphuric ether placed under a recipient of atmospheric air, prevented the seeds from growing, without altering the quantity of oxygen in the air. The same happens with camphor, oil of turpentine, assa-fetida, vinegar and ammonia. Putrefied bodies prevent germination, by the abundance of carbonic acid gas they emit. It appears from the preceding facts that oxygen is indispensibly necessary to germination, and that it serves to carry off from the grain that carbon which is disengaged by fermentation. But this rule is not without its exceptions.

In fact peas have germinated in water deprived of air by every possible means, and at whatever depth they have been immersed. The seeds of beans, lentilles, spinach, lettuce and corn, grow in the same manner beneath the water with greater or less facility. These seeds germinate better in water charged with oxygen gas, than in water entirely deprived of it, but not at all in water charged with carbonic acid. The acids retard their germination. The air emitted by peas under pure water, is a mixture of carbonic acid and carbonated hydrogen.

Peas have germinated in pure hydrogen gas and in air, where other seeds have already germinated, and they have totally exhausted the oxygen it contained. In this experiment the hydrogen gas becomes loaded with carbon. They likewise

wife germinated in azote gas. They do not germinate in oil; but if after having been swelled in water they are put into oil, they germinate very well.

These facts afford new inductions in favour of the decomposition of water in germination, and consequently in vegetation.

Bull. des Sc. x. No. 55.

Mémoires d'Agriculture, &c.—p. 79.

At the head of this volume are the order of the prefect for printing it, the rules of the Society, and a list of its ordinary and corresponding members, with an account of the Society's labours: after which are the following memoirs.—Instructions for preserving wheat from smut: by CC. Cadet-de-Vaux, Parmentier, Saint-Genis, and Yvert.—Report of the experiments of C. Houdart, junior, on preparing and economising feed.—On the means of draining various lands by simple and not expensive processes, by C. Chassiron. This memoir, which has been published separately, is preceded by some observations on the general system of inland navigation in France, and followed by a comparative table of the coal-mines worked in each department, and of those which require only navigable canals and rivers to enable them to be worked. The former are fifty-one in number; the latter, sixty. Their importance to those of the French manufactures that require fuel, or mechanic arts, and agriculture, must be obvious, at a time when they are perhaps not sufficiently aware of the want of wood, with which they are threatened, from the great devastation of forests in most parts of the republic; a subject which has been treated of by C. Lasterie in a separate memoir in this volume.—On the precise signification of the terms *agriculture* and *rural economy*, by C. Cels.—Some reflections on the supposed number of sheep in France, by C. Delong. The intention of this memoir is to excite inquiry concerning this important subject.—The advantages of nurseries on estates of a certain extent, in facilitating such annual plantations as may be suited to them, by C. Villele.—An interesting account of the successful amputation of the fore-leg of a cow, which had been fractured, by C. Chaumontel.—Experiments, inquiries, and observations on elms, by C. Boucher; to which C. Denor-gelles has added his experiments for obtaining alcohol from the sap of vegetables.—On the product of different sorts of wheat that are cultivated, and the melioration of them; or the advantages that would result from inquiring what sorts of wheat

Memoirs of the Agricultural Society of the department of the Seine.

wheat yield the most bread; by C. Chancey.—On rural edifices, by C. Garnier-Deschénes.—On the manner in which the mountains in the Cevennes are fertilized, by C. Chaptal.—On the means of rendering fit for use wells that have been abandoned in consequence of the mephitization of the soil, by C. Cadet-de-Vaux.—Observations on the working of mines, by C. Creusé-Latouche.—On the cultivation of the sugar-cane in the Caribbee islands, and particularly of that of Otaheite by C. Moreau-St.-Mery.—On the cultivation of the sugar-cane, by C. Coffigny.—On the cinnamon-tree of French Guiana, by C. le Blond.—The volume concludes with accounts of the lives of Cretté de Palluel, and T. Francis de Grace.

BOOKS OF SCIENCE,

Imported by Deboffe, of Gerrard-Street, Saho.

Books of science
imported.

HISTOIRE Naturelle des Oiseaux de Paradis, par Viellôt, No. 13, 1l. 15s,

Dictionnaire raisonné & universel des Arts & Métiers, par Jaubert, 1801. 5 Vol. 8vo. 1l. 11s. 6d.

Manuel du Voyageur à Paris, An. X. 2s. 6d.

Voyage pittoresque & physico-economique dans le Jurat, par Lequinio, An. ix. 2 Vol. 12s.

Geographie, moderne & universelle, par Lacroix, précédé d'une Traite de la Sphere & d'un d'Astronomie, 1800, 2 Vol. 8vo. avec Cartes, 18s.

Nouveau Dictionnaire François-Italien, & Italien-François, Abregé d'Alberti, 1801. 2 Vol. 8s.

Respecting agri-
cultural infor-
mation.

In answer to the obliging letter of *A friend to Agriculture*, recommending that subject to constitute part of the present Journal, I am to observe, that though this most interesting department of human industry and research is of the first importance to society, and its processes are scientific throughout, yet from the complicated number of causes to be developed, the considerable time required for experiment, the large scale of operation, the uncertainty of reporters, and other considerations, I have been less forward to press this object, than from its high value I should else have been. Communications, selections, or accounts, which from their authenticity and their decisive effect, may tend to establish points of essential value, will undoubtedly conduce to the purposes of our publication, and in this respect I shall thankfully avail myself of the liberal offer of my correspondent.

A
JOURNAL
OF
NATURAL PHILOSOPHY, CHEMISTRY,
AND
THE ARTS.

MARCH, 1802.

ARTICLE I.

Description of an Engine which operates by the Pressure and Descent of a Column of Water against a Piston; nearly in the same Manner as the double Steam Engine operates by Means of Steam. Communicated by the Inventor Mr. RICHARD TREVITHACK, of Camborne, near Truro, in Cornwall.

IN a late conversation with the inventor of the engine which forms the subject of the present memoir, the method of applying a column of water as a first mover, by its alternate action upon a piston in a cylinder, was mentioned by me as likely to prove advantageous in a variety of situations, and probably to afford as beneficial a result with regard to power, as any of the other ways of applying a fall of that fluid. It was with no small gratification, that I found this skilful engineer had amply considered the subject, and had carried it into full effect. I immediately saw, that the communication of results so interesting and authentic, would be highly acceptable to my readers, and honourable to the Journal. Upon my request, he with great readiness and liberality supplied me with the drawing exhibited in Plate IX. and had the goodness to dictate the materials, whence the following description was made.

Application of
an inclosed column of water as
a first mover.

History of a new engine for raising water by an inclosed column.

The engine, of which a section is here given on a scale of half an inch to a foot, was erected three years ago at the Druid Copper Mine, in the parish of Illogan, near Truro, in Cornwall.

Description of the parts, and their organization.

It was worked about two years; but the mine has not proved sufficiently beneficial to encourage the proprietors to go on during the last twelvemonth. A B represents a pipe six inches in diameter, through which water descends from the head to the place of its delivery to run off by an adit at S, through a fall of 34 fathom in the whole; that is to say, in a close pipe down the slope of a hill 200 fathoms long, with 26 fathoms fall; then perpendicularly six fathoms, till it arrives at B, and thence through the engine from B to S two fathoms. At the turn B the water enters into a chamber C, the lower part of which terminates in two brass cylinders four inches in diameter; in which two plugs, or pistons of lead D and E, are capable of moving up and down by their piston rods, which pass through a close packing above, and are attached to the extremities of a chain leading over, and properly attached to the wheel Q, so that it cannot slip.

The leaden pieces D and E are cast in their places, and have no packing whatever. They move very easily; and if at any time they should become loose, they may be spread out by a few blows with a proper instrument, without taking them out of their place. On the sides of the two brass cylinders, in which D and E move, there are square holes communicating towards F and G, which is an horizontal trunk or square pipe, four inches wide and three inches deep. All the other pipes G, G and R are six inches in diameter, except the principal cylinder wherein the piston H moves; and this cylinder is ten inches in diameter, and admits a nine foot stroke, though to accommodate the drawing to our Journal, it is here delineated as if the stroke were only three foot.

The piston rod works through a stuffing box above, and is attached to M N, which is the pit-rod, or a perpendicular piece divided into two, so as to allow its alternate motion up and down and leave a space between, without touching the fixed apparatus or great cylinder. The pit-rod is prolonged down into the mine, where it is employed to work the pumps, or if the engine were applied to mill work, or any other use, this rod would form the communication of the first mover.

K L, is a tumbler or tumbling bob, capable of being moved on the gudgeons V, from its present position to another, in which the weight L shall hang over with the same inclination on the opposite side of the perpendicular, and consequently the end K will then be as much elevated as it is now depressed.

New engine for raising water by the descent of a column inclosed in a pipe.

The pipe R S has its lower end immersed in a cistern, by which means it delivers its water without the possibility of the external air introducing itself; so that it constitutes a torricellian column, or water barometer, and renders the whole column from A to S effectual, as we shall see in our view of the operation.

The operation. Let us suppose the lower bar K X of the tumbler to be horizontal, and the rod F O so situated, as that the plugs or leaden pistons D and E shall lie opposite to each other, and stop the water ways G and F. In this state of the engine, though each of these pistons is pressed by a force equivalent to more than a thousand pounds, they will remain motionless, because these actions being contrary to each other, they are constantly in equilibrio. The great piston H being here shewn as at the bottom of its cylinder, the tumbler is to be thrown by hand into the position here delineated. Its action upon O F, and consequently upon the wheel Q, draws up the plug D, and depresses E, so that the water way G becomes open from A B, and that of F to the pipe R: the water consequently descends from A to C; thence to G G G, until it acts beneath the piston H. This pressure raises the piston, and if there be any water above the piston, it causes it to rise and pass through F into R. During the rise of the piston, (which carries the pit-rod M N along with it) a sliding block of wood I, fixed to this rod, is brought into contact with the tail K of the tumbler, and raises it to the horizontal position, beyond which it oversets by the acquired motion of the weight L.

Operation, or working process.

The mere rise of the piston, if there were no additional motion in the tumbler, would only bring the two plugs D and E to the position of rest, namely to close G and F, and then the engine would stop; but the fall of the tumbler carries the plug D downwards quite clear of the hole F, and the other plug E, upwards quite clear of the hole G. These motions require no consumption of power, because the plugs are in equilibrio, as was just observed.

New engine for
raising water by
the descent of a
column inclosed
in a pipe.

In this new situation the column A B no longer communicates with G, but acts through F upon the upper part of the piston H, and depresses it; while the contents of the great cylinder beneath that piston are driven out through G G G, and pass through the opening at E into R. It may be observed, that the column which acts against the piston is assisted by the pressure of the atmosphere, rendered active by the column of water hanging in R, to which that assisting pressure is equivalent, as has already been noticed.

When the piston has descended through a certain length, the slide or block, at T, upon the pit-rod, applies against the tail K of the tumbler, which it depresses, and again oversets; producing once more the position of the plugs D E, here delineated, and the consequent ascent of the great piston H as before described. The ascent produces its former effect on the tumbler and plugs; and in this manner it is evident that the alternations will go on without limit: or until the manager shall think fit to place the tumbler and plugs D E in the positions of rest; namely so as to stop the passages F and G.

The length of the stroke may be varied by altering the positions of the pieces T and I, which will shorten the stroke the nearer they are together; as in that case they will sooner alternate upon the tail K.

As the sudden stoppage of the descent of the column A B, at the instant when the two plugs were both in the water way, might jar and shake the apparatus, those plugs are made half an inch shorter than the depth of the side holes; so that in that case the water can escape directly through both the small cylinders to R. This gives a momentary time for the generation of the contrary motion in the piston, and the water in G G G, and greatly deadens the concussion which might else be produced.

Former attempts to make pressure engines, upon the principle of the steam engine, have failed, because water not being elastic could not be made to carry the piston onwards a little, so as completely to shut one set of valves and open another. In the present judicious construction the tumbler performs the office of the expansive force of steam at the end of the stroke.

Rate of work
by these engines.

There are several other engines of this construction at work. The general rate of working of all these engines is, that four feet

feet of water in its descent will raise three to the same height with well made pump work, with the velocity of one foot and a half per second; that is to say, the present engine works ten strokes per minute, and this load is better or more productive, than when either the velocity or the mass are increased.

A much larger engine of the same construction is at work at Trenethick Wood Tin Mine in the parish of Wendron, near Hailstone. It has a cylinder seventeen inches in diameter, and works by a nine foot stroke, ten strokes per minute. The whole fall is thirteen fathom. It has been in constant work nearly three years night and day, with little or no repair, the working parts being so few and simple. This engine must throw up about ten cubic feet per stroke, or 6000 feet per hour, which is about 750 hogshheads.

There is another new engine in the cliff at the Land's-End, to clear the Riblows Tin Mine in the parish of St. Just, which is under the sea. Its cylinder is five inches in diameter, stroke eight feet, and fall twenty fathom.

Mr. Trevithack has erected many single pressure engines, the construction of which I hope hereafter to communicate to my readers.

Account of a larger pressure engine.

Single pressure engines.

II.

Experiments and Remarks on the Passage of Heat through Fluids downwards, particularly with Regard to the Uncertainty produced by the Vessel; with a Method of obviating that Uncertainty altogether. By JOHN MURRAY, M. D. Lecturer on Natural Philosophy and Chemistry at Edinburgh. Communicated by the Author.

Edinburgh, Jan. 20, 1802.

THE opinion which Count Rumford has advanced, that fluids are non-conductors of caloric, may still be considered as admitting of discussion. Though supported by a number of experiments contrived and executed with the greatest ingenuity and address, it is regarded by many chemists as doubtful, whether it is established to the full extent that Count Rumford has stated it, or whether the phenomena attending change of temperature in fluids justify more than the conclu-

Count Rumford's opinion that fluids are non-conductors of heat is doubtful;

sion,

but the experiments offered to decide the question abound with difficulties.

tion, that they conduct caloric in a very imperfect degree. From a series of experiments which I have undertaken on this subject, I have been convinced, that investigations respecting it are liable to sources of error more important, and more difficult to be avoided than might *a priori* be supposed, and that we have no experiments sufficiently unobjectionable to decide the question. The observations I shall have to offer in the following memoir, will I trust justify these assertions.

Communication of heat through solids;

When caloric is communicated to the surface of any solid substance, the temperature of the whole mass is increased with more or less celerity, and becomes uniform. In this case the caloric passes from one particle of the solid to another, and is thus equally distributed through the whole. When caloric is communicated to a mass of fluid, its temperature is likewise uniformly increased, and in this case also it was supposed, that the caloric is transmitted through the fluid, as in the former example through the solid. Count Rumford denies the possibility of such a transmission, and conceives the change of temperature in the fluid to be produced in another mode.

and fluids.

Circulation of fluids from heat.

When any portion of a fluid is heated it must necessarily be expanded, its specific gravity must be diminished, and from its mobility it must change its place. If therefore caloric be communicated through a solid surface to a fluid, the portion of fluid immediately in contact with the solid, when heated, will acquire a specific gravity different from that of the mass; if the caloric is communicated from beneath, the heated portion of fluid must ascend, its place will be occupied by another portion, and thus the whole mass will be successively brought into contact with the heated surface, and will have its temperature increased. It is in this mode only according to Count Rumford, that the temperature of fluids can be changed. They can receive caloric from any solid matter with which they are in contact, but the heated portion communicates no part of its caloric to the rest of the mass, and the change of temperature which the whole suffers is owing solely to the motions of its parts.

The circulation does not *absolutely* prove the Count's opinion.

That it is in a great measure owing to this cause, has been clearly demonstrated by Count Rumford's experiments. He has shewn, that when heat is applied to a fluid, motions of its parts take place, and that whatever retards or obstructs these motions, diminishes the celerity with which the temperature

is changed. It is evident, however, and is admitted by Count Rumford himself, that the experiments by which these facts are established, considered in themselves, do not prove the proposition, that change of temperature in any fluid is solely effected by this cause, for although these motions may accelerate the change, it is still possible, it may likewise in part be owing to a communication of caloric from one part of the fluid to another.

There is another principle, however, from which Count Rumford's opinion may be established. It is evident that if it be just, a fluid must be incapable of being heated downwards. If a hot body be applied to its superior surface, the upper stratum of fluid will have its temperature raised, but it will communicate no part of the caloric it has received to the fluid beneath, and as it cannot change its place, but must remain at the surface, the under parts of the mass must remain unaltered with respect to temperature.

It is by establishing accurately the fact with respect to this point, that the question regarding the conducting power of fluids must be determined. Count Rumford has made a number of experiments to prove the proposition, that caloric is not propagated through a fluid downwards. Of these the most conclusive seems to me to be that in which a heated cylinder of iron was suspended in olive oil, and distant only two-tenths of an inch from a projection of ice fixed at the bottom of the vessel, without any of the ice being melted. On the same principle I employed the apparatus, of which a representation is given Fig. I.

The thermometer A is bent so that the leg *a*, which issues from the bulb is longer than the leg *b*, to which the scale is attached. It is so far filled with mercury, that at any moderate natural temperature the leg *a* shall remain completely filled. At the bottom of *b* the scale commences with 20° of Fahrenheit. This bent thermometer is attached to a glass rod, inserted in a circular piece of wood. This is fixed by means of wax to the bottom of a glass cylindrical vessel B, three inches in diameter, and nine in height. With this apparatus, the following experiments were made.

Experiment 1. Into the vessel B, water was poured till it covered the bulb of the thermometer $\frac{1}{4}$ of an inch; its temperature was 46° of Fahrenheit, which was likewise the temperature

But it might be established by shewing that fluids cannot be heated from above.

Many of the Count's experiments are directed to this proof;

particularly that in which an iron cylinder did not melt ice placed beneath olive oil.

New experiments. Apparatus.

I. Heated oil, poured upon water, heated a thermometer through the water downwards.

perature of the air of the room. One ounce of olive oil heated to 140° was poured on a small piece of card, suspended on the surface of the water, and the card was slowly withdrawn. Any motion of the water was thus avoided. In the course of a minute the thermometer began to rise slowly, in five minutes from the commencement of the experiment it had risen four degrees, in ten minutes 6½, in fifteen minutes eight degrees. It then became stationary, and continued so for seven minutes before it began to fall. Its descent was very slow.

II. A brass ball at 212° also gave heat downwards. Experiment 2. Into the vessel B, water at 49° was again poured, till it covered the bulb of the thermometer one inch. A brass ball 1½ inch in diameter, was heated to 212 in boiling water, and suspended over the bulb of the thermometer by a wire, previously adjusted so as to be distant from it ¼ of an inch. For 2½ minutes after immersion of the ball, the thermometer did not seem to be affected, in five minutes it had risen a degree and a half, in ten minutes from the commencement of the experiment 4½, in 15 minutes 7½, in 20 minutes 8½ degrees. It then became stationary, and did not begin to descend till 15 minutes more had elapsed. By suspending a thermometer represented by C in Fig. 1. so that its bulb was merely immersed under the surface of the water, the rise of temperature in the fluid in contact with the bulb was found to be in a few minutes 82, from which point it again descended gradually.

It may perhaps be more satisfactory to have this latter experiment stated more minutely in the form of a table.

Temperature of the air of the room, and of the water in the vessel 49°.

In 3 minutes after immersion of the heated ball,

				Therm. A 49½	Therm. C 78
5 min.	-	-	-	50½	- 82
10	-	-	-	53½	- 73
15	-	-	-	56½	- 69
20	-	-	-	57½	- 65
30	-	-	-	57½	- 62
40	-	-	-	57	- 60
50	-	-	-	56½	- 58½
65	-	-	-	56	- 56

On repeating both these experiments similar results were obtained with variations so inconsiderable as not to affect their accuracy.

In these experiments then a quantity of caloric was conveyed downwards through a portion of fluid, so as to occasion a considerable rise of temperature in the thermometer, in the 1st experiment to the extent of eight degrees in 15 minutes, in the 2d, $8\frac{1}{2}$ degrees in 20 minutes. From these results, the conclusion might seem just, that the fluid must possess a conducting power. Further investigation, however, will shew that this is not so certain, as at first view it may appear. It is rendered doubtful by the circumstance, that in all experiments of this kind a quantity of caloric must be conveyed by the sides of the vessel. This quantity it is scarcely possible to ascertain with any accuracy, and of course we are unable to determine what share it has in occasioning the rise of temperature, and therefore whether it is the sole cause, or whether any part of that rise depends on the power the fluid has of conducting caloric.

Whether the sides of the vessel were the sole cause of this transmission.

That in these experiments caloric must be conveyed to the thermometer by means of the vessel in which the fluid is confined, may be easily shewn. In the first experiment, when the heated oil was poured on the surface of the water, it came immediately in contact with the sides of the vessel. The glass must of course have been heated, and it would conduct caloric in every direction. The portion of caloric conveyed downwards would again be communicated to the cold water in contact with the sides, this being expanded, and having its specific gravity lessened could not remain touching the vessel, but must have formed a heated current rising from its sides, and extending beneath the oil. A descending current must consequently have been formed in the axis of the vessel, and a stratum of heated water must have been constantly accumulating. The thermometer would thus come to be affected sooner or later, proportioned to the depth of the bulb in the fluid, and it would continue to rise till the temperature of the whole portion of fluid over it became nearly uniform. A similar effect would be produced in the second experiment, as the heated ball would immediately communicate part of its caloric to the portion of water with which it came in contact, and this flowing towards the sides of the vessel, and being constantly succeeded by other heated portions, must have communicated caloric to the glass.

Development of the manner in which a fluid is heated downwards by its containing vessel.

It

It cannot be known whether this be all that happens.

It may be supposed perhaps, that the quantity of caloric thus conveyed by the vessel would not be sufficient to produce the rise of temperature which took place in these experiments. But how is this to be ascertained. It may appear probable, but until it is proved, the point must remain doubtful, and the experiments must be therefore inconclusive.

To surround the vessel externally with water

It was an obvious idea, that this source of error might perhaps be obviated in a great measure by surrounding the vessel with water, which would carry off the caloric conveyed by its sides. It is evident, however, that it could carry off only part of it, for part must still continue to be abstracted from the internal surface by the water in contact with it. And even the quantity taken from the external surface of the jar by the water surrounding it, would be only somewhat greater than what would be carried off by the atmosphere when the experiment was performed as described above.

promised to be of some use. Experiment. Heat was found to descend in the internal and external water.

The experiment however of surrounding the vessel with water might afford some information: it would at least prove, that caloric was conveyed by the sides of the vessel, and it might indicate in some measure the quantity conveyed. I accordingly performed it in the manner represented in Fig. 2. D being merely a cylindrical glass vessel six inches in diameter, in which the apparatus used in the former experiments was placed. Water was poured into it, to the same height as in the internal vessel, and a thermometer was suspended in the water, the bulb being at precisely the same distance from the surface, as the bulb of the bent thermometer in the vessel A. The brass ball heated to 212° was suspended in the water in the latter vessel, and at the same distance from the thermometer as in the preceding experiments. The following were the results. At the commencement of the experiment, both thermometers were at 46° .

In 3 minutes. the internal thermometer

A $46\frac{1}{2}$ the external E still 46

5 min.	-	-	-	$47\frac{3}{4}$	-	-	-	$46\frac{1}{2}$
10	-	-	-	$48\frac{1}{2}$	-	-	-	$47\frac{3}{4}$
15	-	-	-	$49\frac{1}{2}$	-	-	-	$48\frac{3}{4}$
20	-	-	-	$49\frac{1}{2}$	-	-	-	$48\frac{3}{4}$
30	-	-	-	49	-	-	-	48

Many reasons why this experi-

This experiment proves nothing more, than that a quantity of caloric is conveyed by the sides of the vessel. It might perhaps

perhaps be supposed, that by comparing the rise of temperature in the two thermometers, a conclusion might be drawn with respect to the mode in which the caloric was conveyed to them. If it were intirely conveyed by the sides of the vessel, since as much ought to be given out by the external as by the internal surface, the water without should be heated as much as that within, and consequently the two thermometers should rise equally, and to the same extent. But if the thermometer in the inner vessel rose more than that in the outer, it might be supposed, that the interposed fluid had directly conveyed to it part of the caloric from the heated ball above, with which it was more nearly in contact. But to establish such a conclusion from any differences of this kind, certain circumstances are indispensable, which are absolutely unattainable. It is requisite, for example, that both thermometers should be precisely on the same level, at the same distance from the sides of the vessel, and covered with the same quantity of water occupying the same volume. The smallest variation in these circumstances would produce a variation in the result. But if they were even obtained alike, the situation of the vessels must still remain very different; the one for example, presents a much more extensive surface to the surrounding medium than the other, and the nature of that medium is different, the internal vessel being surrounded with water, the temperature of which is augmenting while the experiment continues, the external with atmospheric air, whose temperature remains the same. It is impossible to estimate the differences in effect which must arise from these differences in situation, and consequently no conclusion can be drawn from the comparative alterations of temperature in the respective thermometers, as to the quantity of caloric conveyed to either of them by the sides of the vessel.

The preceding experiments then, or any of a similar nature, are incapable of determining the question respecting the conducting power of fluids. In all of them a quantity of caloric is conveyed by the sides of the vessel in which the experiment is made, and this quantity we have it not in our power to ascertain, so as to determine whether it is adequate or not to produce the augmentations of temperature which actually take place, and consequently whether any part of that augmentation is to be ascribed to a conducting power in the fluid.

The sides of the vessel will always conduct heat;

and no precaution can insure the object of the experiment.

Every precaution that can be taken to obviate this source of error, defeats the purpose of the experiment itself, since such precautions tend equally to lessen the effect which would result from a conducting power in the fluid supposing it to possess it, and it must therefore remain uncertain to what the diminished effect which takes place where they are employed, is to be attributed.

Other remarks.

If for example, the bulb of the thermometer be placed at a great distance from the matter communicating caloric, it will be a longer time before the thermometer begin to rise, and it will also not rise to so great a degree. But which ever opinion be adopted, whether that the fluid directly conducts caloric, or that caloric is communicated only by the vessel, this ought to be the case, since the circumstances necessary for its transmission in either way are rendered more unfavourable.

In like manner when a wider vessel is employed to contain the fluid, the rise of temperature must be less than when a narrow one is used, because in this case also there must be a larger portion of interposed fluid to be heated.

Or when a large portion of fluid is placed above the bulb of the thermometer, and in contact with the substance communicating the caloric, as with the ball in the preceding experiments, the same diminution of effect must take place, because the caloric given out by the ball being absorbed by a larger quantity of fluid, the temperature of that fluid must be less increased, and it must have less effect either in heating the sides of the vessel, or the thermometer.

General observation or result.

It appears therefore that in all experiments of this kind, a source of fallacy must be present: the effects of this will be more or less considerable according to the circumstances of the experiment, but they cannot be intirely obviated, nor their extent appreciated, so as to admit of a certain conclusion being drawn.

History of the experiments.

It may not be improper to remark, that the preceding experiments were made last winter, were stated in my course of lectures, and a concise account of them published in my Elements of Chemistry. I have now stated them partly to shew the insufficiency of experiments of this kind, either to establish or controvert Count Rumford's opinion, but principally as an introduction to those I have further to relate, and which appear to me to be free from the source of error I have stated.

This

This, of which I at one time despaired, may be attained by the simple contrivance of employing a vessel of ice. If a cylindrical vessel of ice be procured similar to that used in the preceding experiments, and if a thermometer be fixed in it, if on filling it with a fluid at the temperature of 32° , and suspending in it, at a short distance from the bulb of the thermometer, a heated solid, any rise of temperature take place, it may be considered as a certain proof of a conducting power in the fluid. No caloric could possibly be conveyed to it by means of the vessel, since ice cannot have its temperature above 32° , and there is no other mode by which the caloric can pass from the ball to the thermometer than by the interposed fluid. Of the experiments made to determine this point, an account will be given in a subsequent memoir.

A vessel of ice at 32° , containing water at 32° will not raise the temperature of the fluid during its own fusion.

III.

*Letter from Dr. VAN MARUM to Mr. VOLTA, Professor at Pavia, containing Experiments on the Electric Pile, made by him and Professor PFAFF, in the Teylerian Laboratory at Haarlem, in November, 1801.**

THE weather and season of the year preventing these gentlemen from attempting to charge the whole of the great Haarlem battery, consisting of 100 jars, in general nearly a line thick, and containing five square feet and a half of coating each, with the galvanic pile, they took five-and-twenty of these jars, which they charged separately, a few at a time, and all together; and uniformly found the single jars or the batteries charged to the same degree of intensity as the pile. They had taken twenty-six jars, but one of them did not receive the charge well, which they ascribe to the too great thickness of the glass.

Van Marum's experiments on the galvanic pile.

They next charged the battery of $137\frac{1}{2}$ square feet with a greater or less portion of the pile, by folding a hook to every twentieth plate of zinc, to which the insulated metallic wire for producing the communication between the battery and the pile might be conveniently attached. Beginning at

Battery of $137\frac{1}{2}$ square feet charged by it,

* Abridged from the *Annales de Chimie*, No. 120, Vol. XL. p. 289.---C.

taking its electricity at different heights.

the fortieth pair from the bottom, the first where the separation of Bennet's electrometer was distinctly perceptible, the battery was charged to the same intensity as the electrometer indicated when brought into contact with that part of the pile, giving here a separation of one line. The effect was precisely analogous when the battery was charged by similar instantaneous contact with the pile at the sixtieth, eightieth, or hundredth pair, and so on.

The zinc being at top, the electricity positive.

In this pile, the silver being the lowermost of the metals, the electricity was positive at top, and the electricity communicated to the interior surface of the battery was the same, the contact being made with the superior part of the pile.

The metals being inverted, the electricity charged.

The order of the metals was then inverted, and the experiments repeated at different heights of the pile as before, with similar results.

Shocks taken by copper conductors two inches in diameter from the battery thus charged.

They now proceeded to examine the shocks given by the battery charged at different heights of the pile; for which purpose they employed two conductors of copper, two inches in diameter, held in wet hands. Beginning with the battery charged at the twentieth pair, they very distinctly perceived the passage of the stream from the conductor into the hand, and from the hand into the conductor. One gentleman present, Mr. Vander Ende, felt it as far as the wrists. When the battery was charged by forty pairs, real shocks were felt at the wrists: when by sixty, the shocks were very perceptible at the elbows: and they gradually increased, till the shocks extended to the shoulders with considerable strength, when the battery was charged by the whole pile.

The shocks given by the pile itself much stronger.

These shocks, however, were not equal to those given by the pile itself, but only about half their strength; the shock from a hundred pairs appearing to be equal to that of the battery when charged by two hundred.

Comparative experiments made with an electrical machine.

Having continued these experiments till nothing more could probably be learned from them, the comparative effects of the electrical machine, consisting of a plate of glass thirty-one inches in diameter, were tried with the same battery.

Precautions used in conducting these experiments.

This experiment requiring particular precautions, that the contact of the conductor might not impart more electricity to the battery than was furnished by the action of the machine during the contact, Dr. Van Marum formed a communication between the conductor and the ground by touching it with

one of his fingers, and withdrew his finger the moment he brought the large wire into contact with the conductor. This manœuvre he practised repeatedly, till he had acquired a habit of doing it with precision, before he began his comparative experiments; so that he was well assured, that the contact of the conductor, by means of the wire, took no more of the fluid than was furnished by the machine at the instant of contact. A single contact would not give the battery a change, that the electrometer was capable of indicating; but by repeated experiments it was found, that six of these contacts of the conductor imparted to the battery the same intensity as one contact of the pile. The power of the machine being equal to about half what the great machine possessed in its former state, from 1785 to 1789; but the great machine having gained considerably, particularly for charging batteries, by the rubbers of the new construction applied in 1790, and by the use of Kienmayer's amalgama, so that its power was rendered the quintuple of what it was before; the power of the pile of 200 pairs is to that which the great Teylerian machine possesses at present as 3 to 5. The ratio could not be examined directly, because a fire cannot be made in the museum, and the ground on which it stands is very damp in winter: this, therefore, is deferred till spring.

The shocks given by the battery, charged to different degrees of intensity by contacts with the conductor of the electric machine, were now compared with those it gave with similar intensities obtained from the pile; and reiterated trials convinced the experimentalists, that there was no perceptible difference between the sensations or shocks in the two instances, provided the intensities were the same. Hence Dr. Van Marum concludes, as the effects of such a considerable battery, when charged by the galvanic pile, are precisely similar, in every respect, to its effects when charged by a powerful electrical machine, the identity of the fluid put in motion by the pile with that moved by the electrical machine is proved so decisively, that no one will question them in future. These experiments, he adds, joined with those of Professor Volta, render extremely disputable, or rather completely refute the existence of a peculiar fluid, in all the other experiments termed galvanic.

The pile of 200 pairs had six times the power of the machine with a plate 3 inches in diameter,

and three-fifths of that the great Haarlem machine.

The shocks given by the battery, charged by the machine, not at all different from those it gave when charged by the pile to the same height:

the two fluids therefore presumed to be the same.

These

Extreme velocity of the fluid. These experiments have farther proved in a decisive manner, and on a large scale, another important circumstance respecting the pile; namely, that the stream of fluid moved by it has a velocity surpassing all conception; since a battery of $137\frac{1}{2}$ square feet was charged to the intensity it displayed by a contact as short as possible with the wire of communication, a contact that did not continue one-twentieth of a second.

Hence the effects of the pile superior to those of common electrical machines; After this it is no way astonishing, that the pile, by a continuance of its action, should produce such effects as have never been seen where common electrical machines are employed, as the speedy decomposition of water for instance. Certainly no other electrical machine known, the grand Teylerian machine excepted, can furnish a continued stream at all approaching that of the pile; on which account it is a powerful mean of producing several effects, which may contribute greatly to the progress of natural philosophy.

and may be of great use in physics.

Method of insulating the pile. This consideration induced Dr. Van Marum to endeavour to augment the power of the pile. From the beginning he was careful to insulate it more effectually than is commonly done. For this purpose he placed it on a thick cake of lac, and kept it in its vertical position by sticks of sealing-wax two inches long, fixed horizontally in four slips of wood, surrounding the pile. These sticks of sealing-wax were fixed to little wooden cylinders, passing through holes in the uprights at every four inches, and kept in their places only by being made to fit with such a degree of tightness, as would allow them to be moved backward or forward, so as to suit piles of different diameters. The uprights were fixed at top and at bottom in a piece of wood a foot square. Professor Pfaff himself was astonished at the great effect of the first pile composed of three Guilder pieces, plates of zinc of the same diameter, being an inch and a half, and bits of cloth moistened

Wire fused by it. with a saturated solution of muriate of ammoniac. In one of the experiments the end of an iron wire, No. 16, $\frac{2}{240}$ of an inch in diameter, was made red-hot for the length of a line, and even fused at the extremity, by a pile of sixty pairs.

Having read an account of the experiments of Fourcroy, Vauquelin, &c. on the fusion of wire by large plates of copper and zinc, Dr. Van Marum procured thirty-two of each metal, five inches square, and made a pile with them; first
of

of ten inches in diameter, and eight pairs in height, by placing four of each metal together as one plate, they being exactly square, and their surfaces very smooth, that they might be in close contact; and then of five inches in diameter, and thirty-two pairs in height. The power of the higher pile greatly exceeded that of the larger. In August, Dr. Van Marum had fused completely into globules five inches of the iron wire mentioned above, and made seven inches red-hot, with this pile.

Pile of ten inches in diameter.

Another of five.

The powers of piles depend more on their height, than on their diameter.

The number of pairs of metal being increased, the effect was not; fifty pairs producing less than twenty-five, by which nine inches of the same wire were melted when Professor Pfaff was present in November. This they ascribe to the moisture being too much pressed out of the pieces of pasteboard by the weight of so many plates of metal a line and a half or two lines thick; as the upper twenty-five pairs, being taken off, had as much effect as before, while the lower twenty-five had not half the power. In consequence they divided the pile into four, containing together 110 pairs. The plate of copper, placed under and connecting the two piles that were insulated, had a rim, that the solution pressed out of the pasteboard might remain in it, and not wet the insulating cake, and destroy the insulation. These two piles, containing sixty pairs somewhat thinner than the others, when not connected with the other two, made six inches of the wire red-hot. The other two piles, containing fifty pairs, made eight inches very red, and fused great part of this length. This difference was ascribed to the pasteboards not being sufficiently moistened in the former instance. The four piles connected together made twelve inches of the wire red-hot.

Effects not increased in proportion to the height, when the plates are large and thick, because too much fluid is pressed out.

On this account the pile should be divided into several, communicating with each other.

On taking sparks repeatedly at each extremity of the connected piles, by means of a wire communicating with a basin containing quicksilver, no difference between those of the positive and those of the negative electricity could be discerned. Whether issuing, or entering, they appeared radiating, when iron wire was employed; which the experimentalists ascribe to the combustion of the iron, for when a wire of platina was used, no rays were perceptible in the sparks of either electricity. Sometimes the communication was made by means of a needle, fastened to the slender wire

Positive and negative sparks did not differ.

which was fixed to the end of the conducting wire; at other times by the left pointed end of the conducting wire itself.

Beautiful phenomena produced by the combustion of the wire.

When the surface of the quicksilver was touched with the end of a slender wire instead of the needle, a very striking phenomenon ensued: the combustion of the extremity of this wire was effected with such force, that it threw out sparks on all sides, which formed thousands of apparent rays, representing beautiful suns some inches in diameter. By gently lowering the end of the wire in proportion as it was dispersed by the combustion, this appearance could be continued at will. It is seen in some degree likewise when the quicksilver is touched with the point of a fine needle; but then it is of short duration, as it ceases as soon as the needle has left its point. The experiment was repeated with wires of $\frac{1}{240}$, $\frac{1}{151}$, and $\frac{1}{103}$ of an inch in diameter: that of the middle size gave the largest and most brilliant suns, but the smaller succeeds better when the power of the pile is less.

Quicksilver oxidized on its surface by the sparks.

On taking wires too thick to be melted, the oxidation of the quicksilver at its surface by each spark was more distinctly seen, spots of upward of a line in diameter being formed.

Platina fused by the pile.

The extremity of a wire of platina, about $\frac{1}{73}$ of an inch in diameter, was melted, and formed a globule.

Sparks upward of a line in diameter.

The sparks issuing from the end of the communicating wire, when it was not too slender, were more than one-tenth of an inch in diameter.

Piles of an equal number of pairs, though different diameters, give equal intensities, and similar shocks; notwithstanding they differ so much in fusing metals.

On comparing the intensity of the electricity of this pile with that of the former of zinc and silver an inch and a half in diameter, both by the simple contact of the Doctor's most sensible electrometer, and by the condenser and an electrometer of less sensibility, they were found precisely the same, when the same number of pairs were used: they charged the battery before described to the same height: the shocks given by the battery thus charged were in both cases precisely the same: and in those from the piles the difference was scarcely perceptible.

Attempt to account for this.

It appears strange, that two piles so equal as to intensity, and charging large batteries in such an equal degree, should produce such different effects in fusing metals. To form a just notion of this, observes Dr. Van Marum, we must distinguish the action of a pile which is insulated from that of one which is not. In the latter there is a stream passing continually from

from one extremity to the other, and through the conductor or chain of conductors which connects the two extremities: but this stream cannot take place in an insulated pile. From this single distinction it appears, that the equality of the intensities of insulated piles affords no reason to expect an equality of the streams of the two piles when not insulated: on the contrary, if the stream meet with less impediment in a large pile, than in one of smaller diameter, the stream will produce a greater effect, in consequence of its greater velocity.

To see how far this velocity depended on the size of the pieces of pasteboard employed, two piles were constructed, each of twelve pairs of the large plates, in one of which the

Effects of different sized pasteboards.

pasteboard was cut to the size of the plates, in the other to the diameter of half an inch only. The intensities of both were the same, yet the other effects were much greater in the pile with large pasteboards; for it gave very brilliant sparks, which began with the fifth pair from the bottom, while the other pile scarcely emitted any that were perceptible. On making the pasteboards somewhat larger than the metallic plates, the effect was by no means increased, but rather diminished. It was found necessary, likewise, that the pasteboards in the large pile should be well wetted.

These should not be too large: and should be well wetted.

There is another apparent anomaly, however, in the effects of piles differing in diameter: though the action of the large pile is so much more powerful in fusing metals, not the least difference can be perceived in the shocks they give: and this Dr. Van Marum confesses is not accounted for by his hypothesis.

Anomaly not accounted for by the hypothesis.

Some farther experiments were made respecting the efficacy of the solution of muriate of ammonia, which was found to be preferable to common water, or to a solution of muriate of soda, for moistening the cloth or pasteboard. A pile of twenty pairs with the ammoniac solution fused into globules four inches of wire, No. 16; while that with solution of common salt did not fuse or even redden a single line, and that with simple water shewed still less effect with regard to the sparks it produced.

Solution of muriate of ammonia preferable for moistening the cloths.

As several authors have ascribed the greater effect produced by saline solutions to the oxidation of the metals, many experiments were tried, with a view to ascertain this point,

Not because it oxidates the metals, for it is said to be sup-

rior to the more powerful acids. by moistening the pasteboards with sulphuric, nitric, and muriatic acids, both in a concentrated state, and more or less diluted. The particulars are not given, but the results are said not to have favoured the supposition, on a comparison of the intensities, shocks, or sparks; all of which were stronger when muriate of ammonia was employed, than when nitric acid was used, either concentrated or diluted, by which the two metals was very speedily oxidated. As nothing is said here on the fusion of wire, this does not appear to have been tried.

Ammonia alone not equal to the muriate. Effects of the pile in the air, in vacuo, in carbonated hydrogen gas, and in azote gas, equal:

but in pure oxygen gas much increased.

Ammonia alone being used to moisten the pasteboards, the effects produced were all less than with its muriate.

Experiments were likewise made in vacuo, and in different airs. The apparatus employed very readily produces a vacuum in which the barometer falls to below one line; but in this instance the vapor produced by the water of the pile kept the quicksilver at the height of five lines. Between the effects produced in the open air, in this vacuum, in carbonated hydrogen gas, and in azote gas, no difference could be discovered. On the introduction of pure oxygen gas, however, the sparks were much larger, more brilliant, and easier to be obtained: but on making a vacuum after this, the shocks were feebler, and the sparks smaller, than they had been in any of the former instances. Oxygen gas being introduced a second time, its effects were as powerful as before: the cylinder being emptied again, the effects of the pile were reduced as much as before: and on letting in atmospheric air they were restored to the same degree nearly as in the former experiments.

A pile with potash was very strong, but shewed no oxidation.

An experiment of the Doctor was directed to ascertain the presence of oxidation in the use of a very concentrated solution of potash in a pile of twelve pairs of five inches square, which produced much more effect than another similar pile with water only. But on separating the pile neither the copper nor the zinc had suffered any injury in their polish. The Doctor does not say how long the pile stood together.

Very large pile of five inches square.

Lastly, The galvanic apparatus was increased to 200 pairs of zinc and copper in six connected piles of five inches square each. With this he fused an iron wire, No. 16, of twenty-three inches entirely into globules, and ignited the whole of another piece of thirty-three inches.

The

The shock was tried of a column of twenty pairs of copper and zinc of one inch and a half, and of another of the same number of plates of five inches; and also of another of ten inches square; but not the least difference could be perceived. The last mentioned pile (which, as well as the others, was moistened with muriate of ammonia), fused five inches of wire; and the other of five inches square fused four inches. Whence it seems to follow that the effects of these piles, as to the fusion of wire, do not increase in the proportion of their surfaces, but in a less ratio.

The shocks not at all increased by the increase of surface.

Fusion of wire does not increase as the surface, but in a less ratio.

IV.

A Reply to Mr. CRUIKSHANK'S Observations in Defence of the New System of Chemistry, in the Philosophical Journal. By JOSEPH PRIESTLEY, L. L. D. F. R. S. &c. Communicated by the Author.*

HAVING proposed to philosophers the re-consideration of the doctrine of *phlogiston*, which for some time has been almost universally exploded, I am happy to find so truly ingenious and candid a person as Mr. Cruikshank has given some attention to the subject. That experiment of mine which he particularly examines, is that in which I procured a very large quantity of heavy inflammable air from finery cinder and charcoal, both previously exposed to such a degree of heat, as would have expelled from them all the air that mere heat could expel. This I ascribed to the water in the finery cinder uniting with phlogiston from the charcoal. Mr. Berthollet thinks, that this inflammable air comes from the decomposition of the water contained in the charcoal, and Dr. Woodhouse, from that which he allows to be retained in the finery cinder. But Mr. Cruikshank, not satisfied, I presume, with either of these hypotheses, has suggested a very different one, for he asserts, that water is not at all necessary to the production of this inflammable air, maintaining that metals, and their calces, in a very high temperature, have the power of decomposing fixed air, and in this case the fixed air must be formed from the oxygen in the finery cinder, and the carbon in the charcoal.

Short preface and recapitulation.

The heavy inflammable air from finery cinder and charcoal,

ascribed to water either simple or decomposed;

but by Mr. Cruikshank to a decomposition of carbonic acid.

* Vol. V. Quarto Series, page 1.

His experiments with metallic oxides and charcoal, in proof,

are inferred by Dr. P. to prove that the oxides contain water.

Iron or its oxide heated by the solar focus in carbonic acid is stated to have produced no decomposition;

for though part was rendered immiscible with water by thus heating either an oxide or a piece of earthen crucible in it;

yet there was no addition of oxygen, but only azote.

Mr. C. produced heavy inflammable gas from iron filings and chalk heated;

After repeating my experiment, which he found to be just, Mr. Cruikshank did the same with the calces of other metals, particularly those of zinc, copper, lead, and manganese, and then concludes, p. 4, that in all these cases "the air must come from the partial decomposition of the carbonic acid by the calx when raised to a high temperature." But the inference that I think is more naturally drawn from them is, that all these calces contain much water, and little or nothing else. This I have shewn to be the case with respect to several of them, especially that of zinc; though I doubt not but that some small portion of oxygen may be contained in them all. Indeed, we cannot absolutely say, that any substance whatever can be wholly expelled from any other, with which it has been chemically combined by any process.

Before Mr. Cruikshank admitted that iron, or its calx, when raised to a high temperature, can decompose carbonic acid (*i. e.* fixed air) in this experiment, he should have tried whether it would do it in any other. If in any case, I should think it would do it when it was heated in this air by a burning lens, by which a greater heat may be produced than in any open fire. But this I found not to be the case either with iron, or this calx of it. In the last summer I went through a course of experiments with this view; but I always found fixed air not to be decomposed by this means. Though I found that a portion of this air, and also of all the other kinds that are readily imbibed by water, was rendered immiscible in water by means of heat reflected either from a calx of any metal, a piece of earthen crucible, or any other substance, on which I threw the focus of the lens when it was surrounded by this kind of air confined by mercury or water: This, however, was no decomposition of the air, as there was no oxygen found in it after the process. The addition of permanent air was always phlogificated.

Mr. Cruikshank thought, that if this heavy inflammable air came from the decomposition of the carbonic acid by the iron, he should succeed better, p. 4. by employing iron filings in the place of finery cinder, as they would have a greater affinity with oxygen; and with this view he heated them together a quantity of common chalk, previously exposed to a low heat, for ten minutes. From this mixture he procured a great quantity of air, and he thought that the acid (*i. e.* fixed

air from the chalk) was decomposed by the iron; whereas when he used well burned lime he got little or no air. What I infer from this experiment is, that the chalk, not being perfectly calcined, contained some water, as well as fixed air, and that this water uniting with the phlogiston of the iron formed the inflammable air that he found. Water I suppose to be the basis of all the kinds of air, and many substances retain it in any degree of heat. Chalk I have found to do it after long exposure to the heat of a smith's forge.

Admitting the fixed air procured in the experiment with the finery cinder and charcoal to come in part from the oxygen in the finery cinder, how is this oxygen to be expelled from the calx, since heat will not do it? And there is no instance, I believe, in chemistry, in which when heat alone will not expel any constituent part of a substance, it can be effected without the aid of an affinity, in consequence of which some other substance takes its place. But here, according to the new theory, nothing is supposed to take the place of the oxygen in the finery cinder. It takes nothing from the charcoal, but the iron is revived by the mere expulsion of the oxygen.

Mr. Cruikshank lays great stress on the difference that he found in the air that he procured in these processes from that which is got from charcoal and water. But I have observed, that there is a considerable difference in the qualities of heavy inflammable air, not only according to the substance from which it is procured, but in the successive stages of the same process. He will find that I have examined this kind of air as procured from a great variety of substances, made to pass in the form of vapour through hot earthen tubes, and in various other ways, and have given the analysis of them. I always found that the first portions from charcoal were loaded with fixed air, but that in the course of the process this disappeared, the air burning with a lambent flame, and that towards the end it approached to the explosive kinds, as obtained from metals by acids.

I also found that more or less fixed air is procured by the decomposition of heavy inflammable air by means of dephlogisticated air; and though the air procured from finery cinder and charcoal shewed no sign of its containing any mixture of fixed air, nothing of the kind being discoverable by lime

which the Dr. does not infer to be carbonic acid decomposed; but water with phlogiston from the iron.

If the carbonic acid, from finery cinder and charcoal, derive its oxygen from the oxide, this principle must, it is stated, be transferred contrary to the laws of affinity.

The difference between this gas and that from mere water and charcoal, stated to afford no conclusive argument.

Oxygen combined with heavy inflammable air affords carbonic acid, in greater quantity than the latter; which

water;

is inferred to have afforded phlogiston.

water; yet when it was decomposed I found much more than the weight of the air; so that it could not have been previously contained in it in a state of solution, but must have been formed by the union of the oxygen in the dephlogisticated air, and the phlogiston in the inflammable air.

Charcoal supposed to contain carbon and phlogiston.

That charcoal uniting with water should give fixed as well as inflammable air, I account for by supposing, what is by no means improbable, that this substance contains the elements of both the kinds of air, and that they want nothing but water to enable them to take the form of air.

Conclusion.

I hope that Mr. Cruikshank, with the same candour with which he has begun this discussion, will re-consider his hypothesis, and extend his examination to my other arguments in defence of the doctrine of phlogiston, and against the decomposition of water. Nothing but free discussion is necessary to the discovery of truth, and it is desirable that error should be detected as early as may be, especially if the consequence of its reception be extensive and important.

Your's sincerely,

J. PRIESTLEY.

V.

A Statement of the Experiments made by the Rev. ABRAHAM BENNET, F. R. S. on the Electricity produced by the contact of Metals previous to the Year 1789, and also of those made by Mr. TIBERIUS CAVALLO, F. R. S. previous to the Year 1795, to which Allusion was made at Page 144 of this Journal.
W. N.

Short statement of Bennet's experiments, and why they are here repeated.

SOMETIME previous to the period first mentioned in the title to the present sketch, Mr. Bennet had remarkably increased our power of measuring small intensities of single electricity by the application of gold leaf to the bottle electrometer of Cavallo, and by the process known by the name of doubling; an outline of the history of which may be seen at page 396 of the first volume of the Philosophical Journal, in quarto. His *New Experiments on Electricity*, which is a thin quarto of 141 pages, were published in 1789 by subscription; and may perhaps have been less universally diffused in the scientific

scientific world, than if the book had appeared in the usual mode of publication. At all events, as the work is now scarce, and the subject of some interest so far as it may be thought connected with the theory of galvanism, I think it will not be unacceptable to my readers to relate what he did at that early period. The same reasons will in part apply in favour of a concise account of the experiments of Mr. Cavallo.

Soon after the publication of Bennet's doubler in the Philosophical Transactions for 1787, he found that the instrument produced electricity without previous communication, and that it always retained that property, whatever care might be taken to deprive it of any adhering charge. When he was afterwards engaged in a course of experiments facilitated by the mechanism I applied to the doubler in 1788, he found that a very great portion of this adhering electricity might be removed, by turning the handle of the doubler a considerable number of times, while all the plates were connected with the earth, and that by virtue of this provision the instrument might be trusted to indicate the nature of communicated electricity, to a degree of accuracy far exceeding that which could be afforded by any simpler instrument.

Uncertainty of the electrical doubler; from spontaneous electricity,

removed by working its parts uninsulated.

By reasoning upon this phenomenon, he was induced to conjecture, that this spontaneous electricity was not owing to accidental friction, but to what he called the increased capacity of approximating parallel plates, which might attract and retain a charge, though neither of them were insulated. The experiments he made in support or proof of this hypothesis were the following :

Capacity of bodies for electricity supposed to increase by approximation.

He repeatedly tried the effect of depriving the doubler of spontaneous electricity, by turning the revolving plate forty times, with brass wires hooked to all the plates, and he found that if he took off the wires while the revolving plate stood at a distance from the two stationary plates, it was more completely deprived of electricity, than if the wires were taken off when the revolving plate stood parallel to the plate A. That is to say, it required 21 revolutions to exhibit spontaneous electricity after the provision in the first case, and 16 revolutions in the second case. Whence it seemed to him, that the two plates standing parallel to each other, had by an increase of capacity acquired a certain small charge, which

Experiments. The doubler sooner exhibited electricity when cleared and left with its plates opposite, than when at a distance from each other.

sooner

fooner rose by doubling to a perceptible quantity, than that electricity which they might have possessed in the first case.

An insulated copper plate placed in contact with a table, with a large approximating surface became negative.

But to make the experiment in a more direct manner, using the doubler only as an instrument of admeasurement, he took a copper plate thirteen inches in diameter, having its surface rather convex, furnished with an insulating handle of oiled glass four inches long, and baked till the whole was well hardened. One end of this glass was fixed into a copper socket in the middle of the plate, and the other end into wood, that it might not be necessary to touch the electric part of the handle. This copper plate was placed flat upon a mahogany table, and the doubler being deprived of its electricity, the revolving plate B was placed parallel to A, so that B was connected with the earth; then the copper plate was lifted up by its insulating handle, and applied to the plate A. And lastly, the plate B being revolved only five times, caused the gold leaf of the electrometer to diverge negatively to the distance of a quarter of an inch.

The same result when a surface of water was used instead of the table.

It might in this instance easily have been stated, that the contact of the copper plate with the mahogany table, did in fact produce electricity by excitation or friction. But to obviate this, he first repeated the experiment, by touching the copper plate with the point of a needle, and then applying it to the doubler as before, and he found that the instrument did not produce its spontaneous electricity in less than 15 revolutions; after which touching the copper plate again with the needle, he applied it to the surface of some water contained in a large dish, so that its convex part touched the fluid; and then lifting it up he applied it to the doubler, and electricity was communicated, sufficient to cause the gold leaf to diverge negatively at five revolutions, as in the former experiment.

When the touch was reversed the opposite power was obtained.

The last experiment with the water was repeated, with this difference only, that the application of the copper plate was made to the revolving plate of the doubler, instead of the plate A, the revolving plate being moved a little past its contact with the ball, and the plate A being at that time made to communicate with the earth by the brass wire; five revolutions in this case produced electricity as before, but the electricity of the plate A was now positive, as might be expected in consequence of the negative charge having been communicated to B instead of A.

The foregoing experiments were frequently repeated, but as the charge had hitherto been negative, he was desirous of knowing, whether a variation of the nature of the surface might not alter it. He therefore covered the surface of the copper plate with a mixture of gun water and minium, and also with gum water and wheat flour, and he found that this substance when dried upon the surface of the copper, changed the nature of the charge communicated to the plate to which it was applied.

When the plate was covered with gum water, &c. and dried, its electricity became positive.

Lastly, to render what he called the electricity of the approximating plates more conspicuously sensible, he ground a brass plate three inches diameter with emery, till it would adhere to the surface of a piece of black marble. This plate and marble therefore constituted a condenser in its original state. The marble being moderately warmed, he pressed the brass plate upon its surface with the point of a brass wire; then lifting it up with its insulating handle he applied it to the cap of the electrometer, which caused the gold leaf to strike the side negatively.

The condenser affords electricity.

Hence he thinks it must appear evident, from the precautions and experiments he has stated, and from the known laws of electricity. 1. That the doubler may be deprived of accidental or communicated electricity. 2. That the principal cause of its spontaneous charge, is the attraction of electricity by the approximation of its parallel plates. 3. That this charge may be positive or negative, according as the plates or touching wires are composed of substances which have a greater or less adhesive affinity with the electric fluid. 4. That the causes of spontaneous electricity are common to the condenser, both in its original and improved state, and the doubler, and equal in them all, as far as they are equal in their dimensions and powers. 5. That since the doubler may be composed of very small plates, and yet its power be equal to that of a very large condenser, its spontaneous electricity will be more easily overcome by a communicated charge than that of a condenser of equal power, and therefore experiments performed with it will be less liable to equivocal results.

Enumeration of results. 1. The doubler cleared of electricity. 2. Cause of spontaneous charge. 3. and its nature. 4. Common to all condensers. 5. The doubler preferable.

This author proceeded to make other experiments, on the so termed adhesive electricity of metals, and other conducting substances. He deprived the doubler of its spontaneous charge, and placed the two plates A and B opposite each

Other experiments of adhesive electricity; with iron and steel;

each

each other, but so that B was not connected with the earth. He then touched the plate A with the blade of a knife, and the plate B at the same time with the point of a softened iron wire. With sixteen revolutions the gold leaf diverged about one third of an inch positively. The doubler was then again deprived of electricity, and the revolving plate B placed as in the last experiment. The knife was applied to B instead of A, and the soft iron wire to A instead of B, which opened the gold leaf negatively at fifteen revolutions. These experiments were repeated very often, and the electricity changed each time; being always positive in the plate touched with the knife. He remarks, that it would appear incredible, that so minute a difference of adhesive electricity as that which might be supposed between two metals so nearly alike as hardened steel and soft iron could be distinguished, had not the frequent repetition of experiments confirmed it.

with other substances.

He proceeded to make similar experiments, which are tabulated, of different substances, namely, lead ore and lead; lead and iron wire; lead ore and iron wire; tin foil and iron wire; zinc and iron wire. All the experiments having been made by double contact and alternate application of the opposite substances to the plates A and B, he also by single contact determined whether the adhesive electricity, or to state the fact more unexceptionably, the electricity produced by each substance in the doubler, was positive or negative. I have thought it less immediately necessary to state the particulars of these experiments, because I presume that the substances were held in the hand, and from a variety of facts, I think we are justified in concluding that friction, or a contact equivalent to friction, between the human skin and the substance thus held, will produce electricity more than sufficient to render it unnecessary to look for any other cause, or at least quite sufficient to render our investigations uncertain when so conducted. That is to say, I think the results will rather consist of determinations of the kind of electricity produced by friction of the hand upon the several substances, than any new or peculiar affection of the substances themselves.

Objection from the effect of friction by the hand.

Theory of electric excitation.

Among other interesting observations, for which I must refer the reader to the work itself, he gives a simple theory of the excitation of glass, and other electrics used in the construction of our machines. He remarks, that when the silk flap

flap is rubbed by the revolving glass cylinder it is brought into close contact; and the electricity adhering more forcibly to the glass, is carried forward into the open air, which air not having been rendered negative like the silk, does not counterbalance the surface of the glass, and therefore its capacity being lessened, it emits the charge it had just absorbed. And he thinks the amalgamated cushion assists the process, by bringing a surface of a conducting quality, and in connection with the earth into closer contact.

The experiments of Mr. Cavallo were made by letting substances fall out of his hand for the most part upon an insulated plate of tin, whence they were shook off upon a table, or upon a chair; from which he again took the substance up, and let it fall upon the tin plate to the number of times required. After these reiterations he applied his tin plate to the plate of his multiplier. In his experiments a piece of zinc little more than half an ounce, was dropped ten times successively upon the plate, which last, as appeared by the subsequent operations of the multiplier, was electrified negatively. Another piece dropped ten times produced the same effect. Zinc was heated to 110 degrees, and one repetition of the experiment produced the same effect, but stronger. A shilling, an half crown, a new guinea, a piece of copper, a piece of malleable platina, with like manipulation, produced similar effects, but differing in degree. Platina produced very little electricity; but when heated it was found to produce an effect contrary to the preceding; that is to say, it electrified the tin plate positively. A piece of lead appeared to produce negative electricity in the tin; but when hot positive. A piece of iron afforded very equivocal results. A piece of grain tin afforded negative electricity, as well when heated as when cold.—When the cold tin was dropped from a pair of iron tongs, and let fall from the tin plate upon a chair, whence it was picked up by means of the same iron tongs, it produced weak positive electricity. Tin when heated afforded electricity of the same quality, but greater in quantity. Mr. Cavallo alternately used the hand and the iron tongs with results generally like the preceding, that is to say, negative electricity in the tin plate, when the grain tin was dropped from the hand, and positive when it fell from the tongs. Bismuth produced positive electricity; but when the bismuth was made very hot, the

Cavallo's experiments of electricity afforded by the fall of conducting bodies upon a tin plate.

Cavallo's experiments of electricity afforded by the fall of conducting bodies upon a tin plate.

the electricity of the tin plate was negative. These results were the same, when the bismuth was cast into a smooth flat piece, instead of being broken from a lump. When the iron tongs were used with the bismuth, the tin plate became negative, contrary to what it was when the hand was used.

An insulated silver spoon was substituted in the place of the tin plate, and in this zinc dropped from the hand produced negative electricity, which was stronger when the zinc was heated. The kind of electricity was not changed when the spoon was heated, and the zinc cold, but its degree was much less. Mr. Cavallo considers it as a very extraordinary fact, that the experiments varied as to the intensity of the electricity very much on different days, and is inclined to ascribe this difference to the disposition of the atmosphere.

In order to discover the source of the electricity produced in these experiments, he repeated them in a great variety of ways, namely, instead of the hand, he dropped the zinc from a tin plate held with one hand into a spoon, and from the latter back upon the former. He performed this operation with both the tin plate and the silver spoon insulated. He likewise tied a silk thread to the zinc, and holding the other extremity of the thread in one hand, struck the zinc repeatedly against the spoon; but in those cases very seldom any electricity was manifested, except when the weather, and every other circumstance was very favourable, and then the electricity could with difficulty be manifested; yet when the tin plate was held in the hand, and the zinc thrown from it into an insulated spoon, some electricity was more frequently produced than in the other two cases.

Whether animal electricity can be deduced from the preceding facts? &c.

After a careful review of his experiments, he doubts whether the phenomena of animal electricity can be attributed to the cause supposed to operate in them. For as he remarks, the action of metallic bodies produces the same effects, with hardly any observable difference, upon prepared animal limbs; whereas the effects in his experiments were fluctuating, and differed considerably in zinc and bismuth, which nevertheless do not excite the animal electricity more powerfully than zinc and silver, or zinc and gold. He also remarks, that he found by experiments with minute quantities of electricity applied to the prepared limbs, that they were not excited when these quantities were nevertheless very much greater than what was produced

produced in his other experiments. But on the whole, he thinks they seem to establish, 1. That the contact of one metallic substance with another generally produces electricity. 2. That the quantity and quality of the electricity so produced, is various, according to many circumstances which seem to occur in the products of it, or in a great measure to influence it. 3. And that these circumstances are, the various nature of the metallic substances, their various degrees of heat, the state of the atmosphere, the hand of the operator, &c. each of which causes has its share in the result.

VI.

On the Formation of Crystals, describing a Method of producing them large and regular. By CIT. LE BLANC*.

IT had long since been remarked, that the same salt is susceptible of crystallizing under several different forms. C. Haüy has demonstrated, that all these secondary forms are owing to different arrangements of the same integrant molecule; he has shewn that these effects are not the effect of what is termed chance, but that they proceed from laws sufficiently simple, which may easily be determined. Here he has stopped; he has not yet thought proper to publish the ideas which he has given in his course [of lectures] relative to the causes which dispose the integrant molecules to follow such or such a law in their mutual arrangement. These are the causes which Cit. Le Blanc investigates in his observations on the growth of crystals. He has been long engaged in these inquiries, and the memoir which he has read to the Institute is a confirmation and sequel of that which he read to the Academy of Sciences, of which an extract was inserted in the *Journal de Physique*, November 1788, p. 374. He has discovered, by his persevering and ingenious observations, that we may considerably vary both the bulk and form of the crystals at pleasure, by causing them to be formed and to grow under certain circumstances, and he has long since en-

On the causes of crystallization.

Crystals of extraordinary size and beauty.

* Communicated to the French National Institute, and abridged in the *Bulletin des Sciences*, whence the above is translated, No. 50, An. 10.

riched the collections with crystals of alum, sea-salt, sulphate of copper, &c. of an extraordinary size and beauty: he now publishes the means which he has employed.

How made.

Flat-bottomed vessels of glass or porcelain, are the best for obtaining beautiful single crystals. The solutions ought to be brought to the point of crystallization. They first yield crystals that are very small. Amongst these small crystals, which Cit. Le Blanc calls embryos, a selection is made of the nearest, in order to promote their growth, or as C. Le Blanc terms it, to *nurse* (*elever*) them. The liquor is decanted in order to purify it, and the small crystals that have been selected are distributed in it, and carefully turned every day. Amongst these crystals a second selection is made, in order separately to nurse those of which we wish either to augment the volume, or change the form.

Embryo crystals nursed or reared,

by selecting the placing them in the mother water.

In order to make them grow without irregularity, they must be placed in the mother-water of a solution that has afforded a confused crystallization. Care must be taken to turn them often, and to give them fresh supplies of mother-water in proportion as they increase in growth. In this manner they may be brought to a considerable volume.

If they be left too long in a solution in which they have acquired their full growth, they diminish instead of increasing in size, and it is observed that this decrease takes place at the angles and edges, so as to leave striae visible, which indicate the direction of the ranges of subjacent molecules.—The position of the crystals in the solution influences their form: this is particularly remarkable in the prismatic crystals: they grow in length when they are laid upon one of their sides, and in breadth when they are placed upon their base.

They may be made to grow either in length or breadth.

Secondary forms.

Cit. Le Blanc having changed octahedral alum into cubic alum, by placing an octahedral crystal in a solution of alum saturated with its earth, which gives the cube, infers from thence that frequently the secondary forms are owing to differences in the proportion of the principles*.

A curious

* It appears to us that this fact cannot lead, more than any other, to such an inference. According to the experiments of Cit. Vauquelin, the alumine in excess is mixed with the sulphate of alumine, but it is not combined with it; for simple solution in water is sufficient

A curious observation of Cit. Le Blanc, which has already been recorded in the *Journal de Physique*, proves that the same solution left to itself, is not equally saturated in all its parts. If we suspend crystals at different heights in a solution, the lowest crystals increase more rapidly than the higher ones; and it sometimes happens that these dissolve whilst the lower still continue to grow. Citizen Le Blanc adverts to the analogy that subsists between this observation, and that of the more complete saturation of the water of the sea at great depths.

Solutions are more saturated at greater depths.

Cit. Le Blanc informs us, that by adding sulphate of copper which crystallizes in oblique prisms, to sulphate of copper which crystallizes in the octahedral form, rhomboids are constantly obtained*.

VII.

Accounts of the New Planet CERES †.

ON the 4th of February a letter from Dr. Maskelyne was read before the Royal Society, announcing that he had observed the new planet of Mr. Piazzi passing the meridian between three and four o'clock in the morning, having about $188^{\circ} 43'$ right ascension, and $12^{\circ} 38'$ north declination, appearing like a star of the eighth magnitude.

Letters to the Royal Society, announcing observations of the new planet by Dr. Maskelyne, Mr. von Zach, and A. Aubert, Esq.

Another letter from Mr. von Zach was read, informing the Society that he had observed this planet at Scebberg on the 7th of December, within half a degree of the place before

cient to separate it. These crystals are accordingly opaque: besides, the same chemist has obtained cubic and transparent crystals from acidulous sulphate of alumine. (Note of the Editors).

* We must observe that the primitive form of the sulphate of iron is the rhomboid, and that the irregular octahedron which it presents is a secondary form. Cit. Haüy has examined one of these crystals resulting from a mixture of a solution of sulphate of copper with a solution of sulphate of iron. The rhomboid which he examined differed in no respect from the primitive rhomboid of the sulphate of iron. (Note of the Editors.)

† This whole article is taken verbatim from the *Journal of the Royal Institution*.

determined in his journal. Mr. Olbers saw it at Bremen on the 2nd of January. With a power of above 120 it presented no observable disc.

On the 11th a second letter from the Astronomer Royal informed the Society that he had repeated his observation of the new planet, so as fully to ascertain its motion. It appeared to have a visible disc when on the meridian, and viewed with a power of 50. When the air was very clear the disc was round and well defined, but somewhat smaller than that of the 34th of Virgo, a star of the 6th magnitude near it. Dr. Maskelyne observes, that the smallness and roundness of the appearance of the disc of the fixed stars is a good criterion of the clearness of the air.

Another letter from Alexander Aubert, Esq. F. R. S. was also read. Mr. Aubert discovered the planet Ceres on Sunday morning, having about $188^{\circ} 41'$ right ascension, and 13° declination, its motion at present being retrograde.

History of the planet as discovered by Piazzi; observed by Olbers, and considered by Oriani, Zach, Bode, Lalande, and Burckhardt.

Citizen Burckhardt in the Moniteur, 4 Pluv. An. 10. No. 124. gives the following account. The planet which Mr. Piazzi discovered at Palermo the first of January 1801, was again seen the first of January 1802, by Mr. Olbers, at Bremen, nearly in the place where it was expected from the calculations of Mr. von Zach. The 2nd January 1802, at $18^{\text{h}} 58' 36''$, mean time, at Bremen, its right ascension was $185^{\circ} 9'$, and its declination $11^{\circ} 9'$ north, in the wing of Virgo, near a star of which Lalande had given the position, in the *Connaissance des Temps*, Year 9, p. 254. The 5th January, at $17^{\text{h}} 36'$, its right ascension was $185^{\circ} 43'$, and its declination $11^{\circ} 8'$, nearly. It appears as a star of the ninth magnitude, but it will become more conspicuous. With a telescope magnifying 106 times, it cannot be distinguished from a small star.

The 1st January it fortunately made a right angled triangle with two small stars mentioned in Lalande's *Histoire Céleste*; the following day the form of the triangle was changed, and by means of this change the planet was recognised. It will be on the parallel of the 20th of Virgo.

The elements of this planet have occupied several astronomers. Messrs. Oriani, Zach, and Bode, had suspected at once that it was a planet, because it had been observed stationary, and without nebulosity. But having received only two complete observations, they had not been able to confirm their

their suspicions. Some time afterwards, Mr. Lalande first obtained a complete copy of the observations of Mr. Piazzi, who could not refuse them to one, under whom he had so long applied to the study of astronomy. By means of these observations, I was the first that demonstrated, in a memoir presented to the National Institute, that there was no parabolic orbit that could agree with the observations, although confined to an arc of 10 degrees. I gave at the same time the elements of a circular and of an elliptic orbit, and I showed the great uncertainty that necessarily remains when the elements are deduced from so small an arc.

Having received a more exact copy of these observations, Elements of its orbit
Mr. Olbers endeavoured to determine from them the elements of an elliptic orbit; but he found so much uncertainty that he was obliged to prefer a circular orbit, since he thought it impossible to determine if the planet was near its aphelion, or its perihelion. I had proceeded on the former supposition; Mr. Gauss preferred the latter, and endeavoured at the same time to accommodate his calculations to all the observations of Mr. Piazzi: and this he performed with a difference of only a few seconds. These are his elements:

Epoch of 1801	-	-	2s	[17?] ^o	36'	34''
Aphelion	-	-	10	26	27	38
Node	-	-	2	21	0	44
Inclination	-	-	10	36	57	
Greatest equation of the centre			9	27	41	
Heliocentric and tropical diurnal motion			12	50.914		
Mean distance 2.7673.			Eccentricity	.0825.		

Revolution 1681 days, or 4 years 7 months.

I had found the revolution 5 months and a half shorter.

According to M. Lalande's calculations, Mr. Gauss's elements give the longitude greater by a degree than Mr. Olbers's observation; according to Mr. von. Zach, my elements give it four degrees less, and Piazzi's, ten degrees less than the observation.

The idea of searching for this planet among the immense collection of observations of the *Histoire Céleste Française*, could not fail to present itself to all those who have attended to the subject: but it was impossible to undertake the inquiry with any hopes of success, before the elements were corrected by new observations. I shall now apply to it without delay.

Mr. Piazzi has named his planet Ceres Ferdinandia. Lalande proposes to call it Piazzi.

Some account of
M. Piazzi.

Mr. Piazzi was born at Ponte in the Valteline; and was professor at Malta, and at Palermo. When an observatory was about to be established at Palermo, in 1787, he came to Paris; he then went to London, where he procured some excellent instruments; and he has already published two volumes of valuable observations; he is now preparing to measure a degree in Sicily, and Mr. Lalande has already sent him instruments for this purpose.

Extract from Bode's Kurzer Entwurf der Astronomischen Wissenschaften. Berlin, 1794. § 387.

Numerical analogy by which Bode suspected the existence of a planet between Mars and Jupiter seven years ago.

Is it probable that Uranus, or the Georgian planet, is really situated at the utmost limit of our solar world? This appears to be very doubtful, considering the immense space interposed between it and the nearest fixed stars. Other planets perhaps may be still more remotely situated, and may perform their revolutions unseen by human eyes. We can scarcely suppose that any planet exists nearer to the sun than Mercury: but considering the proportions of the distances of the planets from the sun, we observe between Mars and Jupiter, a distance far greater than a comparison of the other distances would lead us to expect, and this space may perhaps be occupied by a planet yet unknown.

This appears to follow from a certain proportion which we find among the distances of the seven planets already known. Calling the distance of Saturn 100, that of Mercury will be nearly 4, of Venus $4 + 3 = 7$; of the Earth $4 + 2 \times 3 = 10$; of Mars $4 + 4 \times 4 = 16$; we then want a planet at the distance $4 + 8 \times 3 = 28$: the distance of Jupiter is $4 + 16 \times 3 = 52$; of Saturn $4 + 32 \times 3 = 100$; and of the Georgian planet $4 + 64 \times 3 = 196$.

Observation; by
whom?

It will, however, still be doubted by many if the conjecture quoted from Professor Bode can be thought to have been probable at the time that it was made. Calling the distance of the Earth 10, the real proportional distances are, in the nearest units, Mercury 4, Venus 7, Earth 10, Mars 15, (Ceres 28,) Jupiter 52, Saturn 95, Georgium 92. Instead of Mars 16, Saturn 100, and Georgium 196,

Letters from Sir Henry Englefield, Bart. F. R. S. to Thomas Young, M. D. F. R. S. on the Planet Ceres.

SIR,

Blackheath, Friday.

I have seen the new planet twice, on Sunday night, and again last night. It is just visible to a common night-glass. Observations of the new planet by Sir H. Englefield, Bart. With a power of 90 in my great telescope it was less bright than the 34 Virginis, near which it is. With a power of 200 no disc is visible, and with 300 I can scarcely say that it has a sensible diameter, more than what arises from irradiation, for small stars seen with such powers always appear dilated.

I looked at the Georgian soon after the new planet, but clouds came on, and I did not try 300 on it last night. With 200 the Georgian is, I am sure, the brighter, and it was a very much more visible object in the night-glass.

Sunday.

Last night I again saw the new planet, and observed it with a power of 400. With this great power it seemed to have an apparent magnitude, but was extremely small, faint, and ill defined. I then turned the telescope to the Georgian (which as you know is very near), and the superiority in size and brightness was very striking. The Georgian was not well defined, but I am sure it was full four times the diameter of the new planet, and much brighter in proportion to the different size. Indeed the brightness of the Georgian is very surprising, its vast distance from the sun being considered. I really think that the diameter of the new planet cannot exceed a second; and it is of a very faint light even for that diameter. I looked then at the double star gamma Virginis, and saw the two stars distant from each other full three times their apparent diameter, a proof of the good adjustment and high power of my telescope. Its diameter very small.

I am, &c.

H. E.

VIII.

*Observations and Experiments relating to the Pile of VOLTA.
In a Letter from JOSEPH PRIESTLEY, LL. D. F. R. S.*

To Mr. NICHOLSON.

DEAR SIR,

Galvanic pile.

HAVING been favoured by Mr. Weatherby Phipson, a young man of Birmingham, with an excellent apparatus for repeating the experiments on the *pile of Volta*, consisting of sixty plates of copper coated with silver, and as many thin rolled plates of zinc, which is a valuable improvement of his own, I have had great satisfaction in observing the results; and though, receiving intelligence of what is doing on the continent of Europe so late as I do here, it is probable that I shall be anticipated in my observations, I shall lay them before you, and, with your approbation, before your readers, after observing, that I have lately received the fourth volume of your excellent *Journal*, but am ignorant of all that has been done since the publication of it.

Its admirable effects not admitted to prove the decomposition of water.

I cannot help expressing my admiration of the ingenuity with which your correspondents and others have pursued this most curious subject; and in general my results are the same with theirs, though I draw different conclusions from them, especially with respect to the modern hypothesis of the *decomposition of water*, which, though almost universally received at present, I consider as wholly chimerical, and unable to stand its ground much longer. Indeed, I perceive that doubts are entertained concerning it by several of your correspondents, and others observe that these experiments give no support to it. To me it is evident that they are far from doing so.

For the oxygen does not bear the alleged proportion to the hydrogen;

though it may happen that the inflammable air from the wire connected with the silver end of the pile, be in the proportion to the dephlogisticated air from the wire connected with the zinc end, which that hypothesis requires, it appears that the latter comes from the air that is merely held in solution in the water in which the process is made; since if, by means of oil upon the water, or a vacuum, access to the atmosphere be cut off, the whole production of air ceases. There is also no production of air when the water has been exhausted of it; and certainly no good reason can be given why, if the water

but arises only from air dissolved or absorbed by the water.

The air ceases to issue, if the at-

itself

Itself consists of these two kinds of air, and this process be capable of decomposing it, air should not be produced from it in all these cases; both the constituent parts of the water being present, and the power of separating them being in full operation. Besides, I find that though the two kinds of air be produced, they are not always in the proportion required by the new theory, the dephlogificated air being much less than is requisite. I have also found it not much better than atmospheric air. The inflammable air I believe to be of the purest kind.

mosphere be excluded by oil or a vacuum.

If this inflammable air come from the decomposition of the water, the water from which it is extracted ought to contain an overplus of oxygen, either in the form of dephlogificated air, or of acid. But the signs of acidity bear no proportion to the quantity of inflammable air produced, and can hardly be perceived at all. I did perceive it when I made the process in water tinged with the juice of litmus, but only by the redness of the froth from the wire connected with the zinc end of the pile, the liquor itself remaining unchanged, notwithstanding a copious production of inflammable air from the other wire. Also, when I introduced a piece of raw flesh instead of the metal connected with the zinc end of the pile, no air came from it, nor did I perceive that the surface of it had acquired any acidity, though inflammable air was produced in great plenty from the other wire.

Other facts.

But, except gold or platina be connected with the zinc end of the pile, there is seldom any production of air from that quarter, the metal in that situation being dissolved; and there is no appearance of its being dissolved by any acid, but, on the contrary, of its being supersaturated with phlogiston. But before I produce the evidence of this, which affords an argument against the decomposition of water that appears to me to be perfectly decisive, I shall relate some circumstances concerning this solution of metals, which I do not find to have been noticed by others.

The suspended metal supposed to be supersaturated with phlogiston.

In general, wires connected with the zinc end of the pile are dissolved, but none so readily as those of silver, even when the wires connected with the silver end of the pile are of the same metal, and give air copiously; but if zinc or iron be connected with the silver end of the pile, any other metal, except gold or platina, connected with the zinc end will be dissolved.

Metallic solutions by galvanism.

Gold.

dissolved. Iron and zinc were the means of dissolving each other. But the surest method of producing this solution of metal was by connecting charcoal with the silver end of the pile. I once dissolved pure gold in this manner, and I preserve the solution as an evidence of it; but I could never do it a second time, though I tried charcoal in several states, perfect and imperfect, &c. nor could I by this process dissolve platina.

Charcoal not dissolved, &c.

Charcoal itself is not sensibly dissolved in this process, and air comes from the pieces connected with both ends of the pile. Suspecting that this air might be that which always comes from charcoal when it is plunged in water, I filled the pores of two pieces of it with water, by means of the air pump, leaving them a long time *in vacuo*. Being then tried, they gave no air of some hours, but from the piece that was connected with the zinc end of the pile there proceeded a white cloud, which filled part of the vessel of water. This, however, soon disappeared, the water becoming transparent again; and after some hours both the pieces of charcoal gave air as copiously as any of the metals had done, and continued to do so as long.

Iron; zinc; copper.

When iron was connected with the silver end of the pile, and copper with the zinc end, the latter was dissolved, but not till after two or three hours. Zinc being connected with the silver end, and copper with the zinc end, the former gave air copiously from the beginning, but it was near two hours before the copper began to dissolve, which (being a flat piece) it did at the corners and edges only, and never from any part of the flat surface. When I added more copper, it began to give air without dissolving, and also some of the green precipitate, which had been formed before, gave out air, and, the bubbles adhering to it, it rose from the bottom of the vessel to the top. This precipitate from the copper, which at first was green, became afterwards of a dark brown, as if the metal had been revived. This too was the case with one vessel in which a solution of silver had continued some time. It has given a coating to the glass that is perfectly white and brilliant.

In four vessels of water, with wires forming the circuit, the pheno-

Having introduced four vessels of water between the two ends of the pile, and having connected each two with silver wires, that leg of the wire, in all the vessels, which was next

to the silver end of the pile gave inflammable air, while, in all of them, the other leg of the same wire was dissolved. When I covered one of these vessels with oil, the production of air and the solution of the wires ceased in them all.

mena ceased, when one of them was covered with oil.

Though, as I have observed, there was a slight appearance of acidity in the water when dephlogisticated air was given out at the wire communicating with the zinc end of the pile, there never was the smallest appearance of it when the metal was dissolved. When silver was dissolved in water tinged with the juice of litmus, and there was a copious production of inflammable air from the opposite wire, I could not perceive the least change of colour in the water.

No acid found when silver was dissolved.

I examined the water in which the process was made, especially when silver was dissolved in it, but was so far from finding the air contained in it more pure than before, that it was evidently less so. Before the process, the standard of this air, with an equal quantity of nitrous air, was 1.1; with the water made turbid and white with the solution of silver, it was 1.2; and after standing till it became black, it was 1.3.

The air in the water was worse than common air.

The black matter from this solution of silver did not contain any oxygen, but was evidently the metal supersaturated with phlogiston; for when it was heated in dephlogisticated air, it diminished it, and converted part of it into phlogisticated air; and when it was heated in inflammable air, it added to the quantity of it, and this appeared, by its explosion with dephlogisticated air, to be as pure as other inflammable air; so that this black powder of silver is similar to the black powder of mercury made by agitation in water, which I have shewn to be mercury supersaturated with phlogiston. Where, then, is the oxygen that ought to be produced in great quantity, if the inflammable air from the wire connected with the silver end of the pile came from the decomposition of the water?

The black powder of silver contains hydrogen, &c.

The glass vessels in which silver has been dissolved in these proportions are tinged of a dark colour, which no acid, nor any other menstruum that I have applied, will take out. This is similar to the case of flint glass becoming black by heating inflammable air in it, the calx of lead in the glass uniting with the phlogiston of the air. In this case, therefore, it is natural to infer that this calx of silver imparts phlogiston to the glass, and that there was nothing of oxygen in it. The surface of this black powder of silver long exposed to the air while it is moist

The glass vessels are blackened, as with hydrogen.

moist becomes white, which is similar to the experiment with mercury, in which the black powder of this metal, produced by the agitation of it in water, becomes white running mercury as it becomes dry, diminishing and phlogisticating the air in which it is confined.

Experiment to shew that the black powder of silver, treated by nitrous acid, contains no oxygen.

The black calx of silver, made by its solution in nitrous acid, is said by Mr. Macquer, in his Dictionary, to be owing to the phlogiston contained in that acid. To ascertain this, I dissolved some pure silver in spirit of nitre, and evaporating the solution, I heated the residuum in thirteen ounce measures of dephlogisticated air, of the standard of 0.82, with two equal quantities of nitrous air, by which it was reduced to eleven ounce measures, of the standard of 1.72, with one measure of nitrous air; so that it was almost wholly phlogisticated air. Consequently this calx of silver contains no oxygen.

Theory. That in the oxidation of the zinc there are plus and minus states of phlogiston produced in the apparatus, and that phlogiston is electricity, or nearly so.

My present opinion concerning the theory of this curious process is as follows. Since the operation wholly depends on the calcination of the zinc, which suffers a great diminution of weight, while the silver is little affected, and all metals lose their phlogiston in calcination, what remains of the zinc in a metallic form in the pile, and every thing connected with that end of it, is supersaturated with phlogiston, while the calcined part, and every thing connected with that end of the pile, is deprived of it. The former, therefore, is in a *positive* state, and the latter in a *negative* one, with respect to phlogiston; and it seems to follow from these experiments, that this is the same thing with positive and negative electricity; so that the electric fluid and phlogiston are either the same, or have some near relation to each other. The silver seems to act principally as a conductor of electricity; for the surface of it is only blackened in some places in this process, in consequence probably of receiving phlogiston from the zinc; but the water is most essential to it, because it constitutes the principal part, if not the whole, of the addition of weight in the calx. Accordingly, in the calx of zinc I have found nothing but water, though it is probable that there is a small portion of oxygen in it.

or two electric fluids, oxygen and phlogiston.

These experiments favour the hypothesis of *two electric fluids*, the positive containing the principle of oxygen, and the negative that of phlogiston. These united to water seem to constitute the two opposite kinds of air, viz. dephlogisticated and inflammable.

These

These experiments tend likewise to confirm the conjecture ^{Muscular motion.} which I advanced in my first publication on the subject of air, concerning *the similarity of the electric matter and phlogiston*; and, together with the proper galvanic experiments, shew, that the same substance elaborated from the aliment by the brain is the cause of muscular motion, the nerves being the most sensible of all electrometers. See the first edition of my Experiments on Air, vol. I. p. 274, &c.

I see no occasion to suppose, with Mr. Volta, that there is any circulation of the electric fluid in this pile. The calcination of the zinc supplies phlogiston as long as it continues, and when that ceases, the operation of the pile ceases with it. I also see no necessity that one end of the pile should be silver and the other zinc; and when both are silver, or both zinc, the operation is the same, nor can I conceive why it should be otherwise. When the pile is properly prepared, the addition of any kind of metal to the ends only serves as a conductor of the electric fluid; and silver, zinc, or any other metal, will sufficiently answer this purpose. ^{No circulation of electricity supposed.}

Had this process succeeded without any atmospheric air ^{Remark.} incumbent upon the water in which it is made, it would have amounted to a full proof of the new theory, one part of the water being deprived of hydrogen, while oxygen abounded in the other, and both of them with the assistance of *caloric*, (though it does not appear whence that could be supplied), assuming the form of air. But this not being the case, the element of the dephlogisticated air evidently coming from the superincumbent atmosphere, the element of the inflammable air must necessarily come from the calcined metals which is a sufficient proof of the doctrine of phlogiston. Whether in this you will agree with me or not, I am,

Dear Sir,

Yours sincerely,

J. PRIESTLEY.

Northumberland, in Pennsylvania,

Sept. 16, 1801.

P. S. In your *Journal*, vol. IV. p. 226. it is said, "the inventor of the galvanic pile discovered the conducting power of charcoal;" whereas it was one of my first observations in electricity,

electricity, made in 1766, and published in the first edition of my *History of Electricity* in the year following. See that edition, p. 598.

Experiment of the pile under a receiver, which completely deprived the air of oxygen.

Second P. S. After the above was written, I covered the whole pile with a large receiver, standing in water, charcoal being connected with the silver end of the pile, and silver with the zinc end, in two vessels of water; when the solution of the silver took place in both the vessels, and the air within the receiver began to diminish. The diminution having come to its maximum in about a day and an half, I examined the air within the receiver, and found it completely phlogificated, being not at all affected by nitrous air. There was evidently, therefore, no dephlogificated air generated, the whole result being the effect of the calcination of the zinc. This experiment, added to that on the black *calx of silver* produced in this process, and on the *water* in which it is made, completes the proof of there being no decomposition of water in this case, and strengthens the argument in favour of the doctrine of *phlogiston*.

IX.

*Experiments and Observations towards determining the Influence of Oxigen on Germination. By Dr. CARRADORI *.*

History of the subject. Authors: Boyle, Homberg, Muschenbrock, Boerhaave, Achard, Ingenhoufz, Humboldt, Decandolle.

IT was long ago ascertained, by the experiments of Boyle and Homberg, that seeds require air for their germination, for it was proved that they do not germinate *in vacuo*. This necessity of air was afterwards confirmed by the experiments of Muschenbrock and Boerhaave, who had supported the observations of all times by the remark, namely, that seeds buried very deep under ground do not germinate, and that a great number of seeds do not even germinate under water, but perish in that situation. When this subject was afterwards studied with greater attention, in order to ascertain the reason why air is indispensible in this operation, it was found to be necessary in consequence of the portion of vital, or oxigen air which it contains: For Achard in the first place, and after

* Journal de Physique, LIII. Vendemiaire. 10.

him other philosophers, have shewn that germination does not take place in any mephitic air; as, for example, inflammable or hidrogen air, phlogistic or azotic air, which are known to contain no oxigen; whence it was necessarily concluded, by a legitimate inference, that of all the atmosphere which we term the air, the oxigen is the only portion necessary to germination. This has been confirmed in a more direct manner by Ingenhoufz, who discovered, that the greater the abundance of oxigen the greater is the rapidity and facility of germination in grains or seeds; which probably led Humboldt to the discovery of the means of accelerating germination, and effecting it even in the most obstinate seeds, by the oxigenated muriatic acid, or even, as Decandolle pretends, of the nitric acid, which are known to be charged with oxigen.

At present it remains to be ascertained what influence oxigen exerts upon growing seeds; that is to say, what precisely are its effects upon germination. In order that germination may take place, it is necessary that there should be a principle of fermentation in the farinaceous substance which resides in the cotyledons or placentæ of the seeds, which substance, as every one knows, envelopes and surrounds the germen or embryo; hence there is reason to believe that this substance, combining with oxigen by means of fermentation, acquires a degree of acidity, and consequently a stimulus proper for exciting the vitality of the germen, and for giving the first impulse to the circulation of the fluids in the embryo; or that, by means of the oxigen, this substance becomes modified so as to acquire particular properties, by which it is rendered capable of affording the first nourishment to the tender fœtus or embryo of the plants; since it has been demonstrated, by the late experiments of Dr. Rollo, that in the germination of the farinaceous seeds, the amylaceous part is converted, by means of the concurrence and combination of the oxigen, into saccharine substance, or even both.

Oxigen is thought to produce a change in the amylaceous part of seeds.

It is not certain, however, that oxigen influences this only; Experiments. that is to say, that these are its sole effects: in order therefore to ascertain this point, I made the following experiments.

I placed seeds or grains of wheat, *triticum*, in a plate with water, in the following manner: I fixed them to the bottom of the plate with soft wax, so as to make them remain in a perpendicular or straight direction, some with the germen upwards,

The seeds of wheat germinate most speedily when the germ is in contact with oxigen.

wards, others with the germen downwards, and so that the water reached precisely to the level of their height; that is to say, that it did not entirely cover them, in order that one of their extremities might be in contact with the air. The season was favourable to germination, it being the month of September, when the thermometer indicated 17° Reaum. or about 21° of the thermometer of 100 degrees. On examining them twenty-four hours afterwards, I found that those which had the germen upwards, or in contact with the air, germinated remarkably well, though all the rest of the substance of the feed was immersed in the water; and that the others, which had been placed in the water with the germen downwards, though one of their extremities was equally in contact with the air, namely, the extremity opposite to the germen, could not well germinate; they merely exhibited some signs of germination; and there was no difference to be perceived between those grains and others which I had placed on their side, not upright or perpendicular to the bottom of the plate, but lying down horizontally, and consequently covered entirely with water. Thus it appears that perfect germination does not take place unless when the part which contains the germen is in contact with the air, although all the rest of the feed be guarded against its immediate contact.

Sprouted wheat grew well where the developed plant touched the oxigen; but did not when it was covered.

I took seeds or grains of wheat which had already germinated in the open air, and by means of the same wax I placed them in the water, some with the germen upwards, others with the germen downwards, in the same vessel, and with the same precautions, namely, not suffering the water entirely to cover them; so that those which had the developed germen, or the small plant directed upwards, were in contact with the air at this point only. When I examined them again, I found that those which had the germen downwards, and which consequently were not in contact with the air at this part, remained as they were, and exhibited no other sign of further germination; whilst in the others, whose germen was exposed to the air, the germination advanced, and the small plant increased remarkably in growth.

The stalk is the part where the oxigen ought to apply.

I afterwards wished to ascertain, if it were indifferent whether all parts of the germen were in contact with the air, or only some of its parts. For this purpose, I chose a number of grains of wheat which had germinated well for twenty-four hours

hours preceding, some of which I placed in the water with only the stalk projecting out of it, whilst all the remaining part was immersed under its surface, and others with the stalk under water, and the small roots above its surface. I did not find that the germination made any progress with those which had their stalk under water; but those whose stalks were in contact with the air thrived and advanced in growth, and in a few days time the plant was developed.

Thus oxygen, or vital air, is necessary to germination, since the tender plant cannot thrive and grow without its immediate contact. Thus we see, that though it has received life by the effect of germination, it cannot preserve it unless it be in contact with the air at this part; that is to say, at the stalk, which possesses an organisation adapted to receive its benign influence, which is necessary to the support of life. The germination commences without the immediate contact of oxygen, but it cannot become vegetation, if I may so express myself, without its immediate contact. It seems, that in order to animate the germen or embryo of plants, and give it life, by means of the circulation and other functions, combined oxygen is sufficient, but that it cannot afterwards subsist, if this element in a free and pure state is wanting to the tender plant.

Germination may begin without free oxygen; but vegetation cannot proceed without it.

In fact, as I have already remarked, and as I have observed still better in the subsequent experiments, the seeds begin to germinate under the water, but their germination ceases and proceeds no farther, unless the air receive the plant already born, or the animated germen. But germination is not effected under water unless in a certain case.

I selected a number of good feeds or grains of wheat; some of which I put into a plate, and poured in as much water as was precisely necessary to cover them; others I put into a deeper vessel, and covered them with a larger quantity of water; others I put into a glass, and covered them with a large quantity of water; and, lastly, I put others into a bottle with a narrow neck, and covered them so that the water reached to the neck of the vessel. After twenty-four hours, I found that the feeds in the first and second vessel had begun to germinate, but none of those in either of the two last vessels germinated, nor did they afterwards.

But no germination takes place unless the water be exposed to the air, &c.

under circum-
stances favour-
able to its ab-
sorption of oxig-
en.

Hence it clearly appears, that as this difference can be referred only to the diversity of the vessels, that is to say, to the different surface which the vessels in which the seeds had been placed expose to the air, and to the different quantities of water in which they had been immersed; or, in other words, to the difference of the action or influence exerted by the oxigen contained in the atmosphere upon the water: germination cannot even commence without the immediate contact of vital or oxigen air; provided, however, that the water in which the seeds are immersed be in a condition to become changed with the oxigen, which is necessary to effectuate such a function. It cannot be doubted but that water powerfully attracts a large quantity of oxigen from the air; it has a strong avidity for this principle, and becomes abundantly loaded with it. M. de Gleichen and Senebier had observed that the seeds of pease, when placed in too large a quantity of water, perished without germinating, but they had given no accurate explanation of the fact.

Recapitulation.

I have thus established two essential facts relative to germination, which, to the best of my knowledge, had not before been pointed out. Vital or oxigen air is necessary to the grand process of germination; but in order to give the impulse or the principle of this germination the immediate contact of the air is not necessary, but it is indispensable to its continuation or progress; since the germen already animated, or the small plant, cannot grow nor vegetate, unless it be in a state to enjoy the immediate influence of this vital fluid. Ingenhousz had only asserted in general terms, that the contact of oxigen is necessary to the germination of grains or seeds; but something more particular was still wanting.

Repetition of
experiments,
with other
plants.

I have repeated the same experiments upon the seeds of barley, *hordeum vulgare*; of beans, *vicia faba*; lupines, *lupinus albus*; and have obtained the same results: hence we may conclude that the above-mentioned inferences are applicable to the seeds of all *terrestrial plants*, that is to say, such as sow themselves upon the dry ground.

Seeds of aquatic
plants germinate
and grow by the
combined oxigen
of water.

As to the seeds of aquatic or marsh plants, it appears, that, both for the commencement and for the continuation of germination, the oxigen which is combined with the water is sufficient, without the concurrence of free oxigen, as we see that they germinate, and afterwards grow very well, under the

the water. Their organisation, different from that of the terrestrial plants, enables them to avail themselves, for the same operations, of the oxygen which is dissolved in the water.

Though seeds can germinate under water, yet by being kept there they lose much of this faculty, and at length become altered to such a degree as to be no longer capable of germination, even though we change their place, and transport them into dry earth. Seeds are injured by lying in water.

I have observed that seeds of wheat, that had been kept in water during three successive days, but not under circumstances to enable them to germinate, and were afterwards transported into dry ground proper for producing this effect, germinated almost with the same vigour as if they had been placed there at first; but the fifth day the greater part ceased to germinate, and those which still germinated did it in a languid manner, and the small plants which they produced were sickly, and without vigour. Experimental proof,

I have remarked, that the same happens with plants which have germinated under water; by remaining there during too great a length of time, these tender plants are spoiled, and no longer capable of growing and thriving, even though they change their situation, and are placed under more favourable circumstances. I have also observed, that this too long abode in the water is the more dangerous to them when these plants are tender; that is to say, nearer to the period of their birth, or commencement of germination. even after germination.

Hence we see what danger arises from too long continued and abundant rains after the seed time. The too great quantity of water keeping the seeds for too great a length of time in a state of submerision, prevents their germinating, or injures their healthy germination, and is the cause why the plants which they produce appear with a constitution more or less altered, in consequence of the prevention of their communication with the air, or, in other words, for want of oxygen. Hence the wet winters, which, for the reasons that have been mentioned, may prove dangerous to the seeds of wheat, the most important of the fruits of the earth, are justly considered as presaging a scanty harvest. Hence the mischief of abundant rains after seed time.

—————Hyemes optate serenas
Agricolæ: hyberno lætissima pulvere farra
Lætus ager—————

VIRG. GEORG.

Dry windy winters are best for the seed.

Dry windy weather is then advantageous, since the oxygen necessary for the grand work of the germination and growth of the tender plants is furnished easily and abundantly by the atmosphere. After this period, that is to say, after their infancy, the plants no longer require oxygen, in order to prosper, but a mephitic air, as I have already shewn in my memoir *On the Fertility of the Earth*,* because in this they find their principal nourishment: thus when the period has elapsed, oxygen is but of very limited utility to vegetation.

X.

On the Choice and Use of a Razor. By a Correspondent.

To Mr. NICHOLSON.

SIR,

January 26, 1802.

IF you think the following observations applicable to your paper on Shaving, you will insert them in some future Number of your Journal.

W. B.

On the choice of a razor.

In choosing a razor (besides the marks you enumerate) prefer that blade whose edge is least blunted or turned after being two or three times drawn upon its edge, from heel to point, on a bit of horn or the thumb nail.

Straping.

In straping care should be taken to give the finishing strokes in the direction in which it is about to be used: that is, if the drawing stroke in shaving is made from heel to point, the razor should be drawn from heel to point upon the strap, and *vice versa*. This observation applies to all fine edges, especially to surgical instruments. For a strong beard, a rounder edge is given by a loose strap; but a keener and more durable one is given by a strap fixed upon some inelastic substance.

* Della Fertilita della Terra. Memoria del Doct. J. Carradori, Premiata della R. Societa Economica di Firenze nel mese di Giugno del 1799.

The soap lather, besides the effects already mentioned, ^{The lather.} seems to act by giving a degree of firmness to the beard. It unites, in some measure, a great number of hairs, and thereby occasions a more equal resistance to the stroke of the razor, diminishing the elasticity of the hair; and also taking off a little of its natural fine polish. In shaving without soap the beard is generally irregularly cut, especially if the edge be not perfectly keen; as may be observed in cutting a bundle of bristles loosely tied, or taking the edge off a quire of paper without putting it into a press. Provided the lather be of sufficient consistence, it is not material whether hot or cold; for I suspect the alkali acts pretty quickly upon the polished surface of the hair.

The form of the razor is of some consequence. Young ^{The form of the blade.} shavers, who may not be equal to giving the drawing stroke, should choose a scimitar-like blade. Every razor ought to have the point terminated by a segment of the circle; otherwise it is difficult to give the stroke from the point towards the heel, which is often necessary when a man is not *ambo dexter*.

Another Correspondent has favoured me with what seems ^{Effect of heat on edge tools.} to be the most probable explanation of the effect of heat on edge tools. He observes, that in the cold regions of North America an axe will sometimes fly in pieces like glass, and that our smiths in this country are well aware of the increase of tenacity which a very slight increase of temperature gives to steel, iron, and other metals, and take care to use it when they set or alter the figure of any tool or utensil by cold hammering. They warm the article to prevent its breaking. He thinks the fine edge of a razor, which would splinter and become rough if strapped or used cold, may perform its office much better when rendered more tenacious by a moderate heat.

W. N.

XI.

*Observations on the Method of painting with Milk. By
CITIZEN DARCET, Member of the Lyceum of Arts, and
Essayer of Money.**

Importance of
substituting ca-
seous matter for
size in painting.

UPON reading the different articles of the Decade Philo-
sophique, in which the method of painting in milk is men-
tioned, and on examining the theory which Cadet-de-Vaux
has developed respecting this useful application of our che-
mical knowledge, I perceived how important it would be if
we could substitute the caseous or cheesy matter, which we
possess in such great quantities, to glue or size, which is
commonly used in painting in distemper, and by this means
to appropriate that substance to paper-hangings and other arts,
for which it is an article of the first necessity. I apprehended
that the process of this new method of painting was susceptible
of being rendered more simple; and I endeavoured to study
the different phenomena in order to ascertain what substance
might be left out in part, or even wholly, without altering
the goodness of the colour. This examination has enabled
me to make the following observations, which may serve as a
supplement to the memoir published on that subject. †

Historical re-
marks.

I shall not attempt to solve the question, whether painting
in milk was known to the ancients. The solution of this
problem, which is perhaps impracticable, is scarcely interest-
ing to us. I shall only remark, that the Indians, who used
milk to dilute the colours with which they painted the sides of
their cabins, appear to have given the first notion of the ap-
plication of a natural mixture of the caseous part along with
the serous part, to render colouring matter adhesive. ‡

For this application we are indebted to Cadet-de-Vaux,
who has by these means afforded a real service to the public,

* Decade Philos. No. 5, An. X.

† See Philos. Journal, quarto, V. page 247.

‡ Our house painters are also acquainted with the advantageous
uses of milk in inside paintings. They have long used a mixture
of milk and well washed lime to give a brighter white to delicate
objects in relief, in order that they might appear more prominent,
from the ceiling painted with the ordinary white-wash.--D.

by rendering a material useful which in many places had, properly speaking, little value, unless in the ordinary use of extracting the butyraceous part, which alone represented the whole value of the milk before its decomposition. He has at the same time given a degree of perfection to this paint, by rendering the process sufficiently simple, to afford a solid colour, nearly without smell and at a moderate price.

These qualities, which painting in milk really possesses, appear to render it little susceptible of amelioration. I shall nevertheless venture to propose one which has succeeded in my hands, and of which the experiments have been made on a scale sufficiently extensive to insure the goodness and the value of the results I have obtained. * Improved process for painting.

After having given an account of the observations which led me to this process, I shall speak of the materials I used, their proportional quantities, the best method of combining them, and, in a word, the process to which we must justly apply the denomination of cheese painting. †

Citizen Cadet-de-Vaux, in his memoir on milk painting, has given two processes, which, as it appears to me, ought to be considered as one, because the first which he announces as similar to common distemper does not differ from the second, which he gives as proper to be substituted instead of oil painting, except in the Burgundy pitch, which constitutes part of this last. In fact, Burgundy pitch renders the colour more solid, but it is far from rendering it capable of being washed like oil paint; a property which is known to be truly characteristic of this paint, and is of itself sufficient to distinguish it from distemper. I shall not, therefore, examine these two processes separately; and I shall conclude my ob- Cadet-de-Vaux's two processes do not differ. Critique on his method.

* I painted an entire chamber with the colour I shall proceed to describe. Individuals, who slept in it the very day of the operation, were in no respect incommoded by the smell of the paint, though the door and the windows were shut the whole night.

† We find, in the *Dictionnaire de Peinture de Pernety*, a note in which he speaks of a pamphlet entitled, *La Peinture au Fromage ou au Ramekin*. It was written in opposition to the encaustic method of painting, of which Citizen Bachelier has, as it were, re-invented the process. I have not been able to procure this pamphlet, for which I am very sorry, as it might probably contain some data respecting the method of painting on which we at present treat in a more serious manner.---D.

ject to be attained, if the process I offer shall afford a colour equally good as that which is obtained by following the process for the resinous milk paint.

We read at page 250 of the memoir to which I allude, that the oil added to the mixture of flaked lime and skimmed milk is dissolved by the lime, and then forms a calcareous soap.

Lime, milk, and oil form a triple compound.

By carefully examining what passes in this operation, I have thought I observed that the lime does not separate from the caseous part to combine with the oil; but that the oil which is added in the mixture forms a triple combination, little soluble in fact, but perfectly diffusible in water. We know, on the contrary, that calcareous soap is insoluble and quite immiscible in water; and I have found that the addition of skimmed milk produces no change in these properties. I have also remarked, that the triple combination does not take place, but in the order described by Cadet-de-Vaux, for the lime does not entirely combine with a mixture of oil and skimmed milk. In this case there is only a formation of calcareous soap, which remains in masses suspended at the surface of the liquid.

Sour milk unfit for the pigment.

Cadet-de-Vaux also announces, in page 248 of his memoir, that sour milk is no longer proper for the composition of this colour. He observes, that the serous part of the milk being converted by fermentation to the state of acetous acid, may then form a kind of calcareous acetite, which, by its deliquescence, must contribute to destroy the colour in which it is mixed.

The whey is of little utility in the paint; but very useful in many other applications.

I have verified this fact, and I think that the serous part cannot be useful in the composition of paint, unless before that period in which the acetous acid shall have converted the sugar of milk it contains into acetous acid. For in the former case it is capable of giving solidity and brightness. But when we consider that the fermentation which produces this phenomenon takes place with much rapidity; that in many countries this serous part is used in bleaching, in the preparation of sugar of milk, and for the feeding of animals, we shall be desirous of retrenching it from a process in which it is sometimes useful, but oftener noxious, in order to appropriate it entirely to these several uses.

By

By examining, in the same manner, the effect of the addition of oil upon the rest of the mixture, we soon perceive that if it does not improve the solidity of the colour, it must either be useless or pernicious; because it renders the tint dull, and communicates a disagreeable smell. Now experiment demonstrates the negative, for milk paint in distemper does not resist water more than the simple mixture of skimmed milk with slaked lime and whiting.

The oil is of no value as an ingredient.

I have also concluded that the quantity of six ounces, or 183,430 grains of slaked lime, prescribed in the recipe for painting in distemper with milk, was much too considerable, because two ounces, or 61,143 grammes, or even a smaller quantity, is sufficient entirely to liquify one French pint, or 951,206 cubic centimeters of skimmed milk. The pellicle of calcareous carbonate, which is formed after a time at the surface of painting in milk distemper, shews, as well as other experiments on this subject, that the present observations are well founded.

The proportion of lime is too great.

With regard to the whiting, I think the dose may be increased without inconvenience. Cadet-de-Vaux already added three pounds, or 1467,438 grammes, to five pounds, or 2445,75 grammes. I have gone further, and have used a dose of eight pounds, or 3913,168 grammes, and the colour I obtained did not appear to me less solid than that made according to the original recipe. This observation does not apply to the preparation, when required to be coloured either by an ocre, an earth, or an oxide. I have remarked, that these substances require more of the mordant than the whiting does; and this happens, in fact, with painting in distemper with milk coloured yellow or red, in order to be applied to pannels, &c. namely, that the addition of these colouring matters deprive it of all its solidity. We must not, therefore, add the colour to the paint entirely mixed, as is directed at page 248 of the memoir, but diminish the dose of whiting in proportion to the quantity of colouring matter necessary to produce the required tint; in a word, it is requisite that the colouring matters added to the whiting should not weigh at most more than the five pounds, or 244,573 grammes. prescribed in the recipe.

The whiting may be increased.

Colour must be added during the first mixture.

These are the principal observations I have made on painting in milk; let us now see what are the consequence we may justly derive from them.

I have

An improved
composition.

I have concluded that the oil or Burgundy pitch, the fetous part, and a portion of flaked lime, might be entirely left out of the recipe. My paint will, therefore, contain only the caseous part, a portion of flaked lime and whiting. Reasoning pointed out these conclusions; but my doubts on the subject were not yet cleared up by experiment.

I formed a great number of mixtures by constantly varying in each of them, in opposite directions, the doses of cheese, of lime and of whiting. Many of my experiments were useless; but I succeeded in discovering the following process, which appears to me to answer the intended purpose. The following are the doses:

Proportion of ingredients.	Cheese or curd well drained	144 grammes =	5 oz. avoird.
	Slaked lime	7 grammes =	$\frac{1}{4}$ oz.
	Whiting	280 grammes =	10 oz.
	Fine powdered charcoal	2 grammes =	1 dram.
	Water	80 grammes =	3 oz.

The kind of
cheese.

This cheese is commonly called *fromage à la pie*, or soft cheese. I have used old cheese which was almost dry, which nevertheless afforded good results, but the fresh cheese is certainly to be preferred. I must also observe that these cheeses differ from each other; they are not all equally proper for the purpose, and I have found some which compose colours of little solidity; they were, in general, disagreeable to the taste.

Manipulation.

Let us now speak of the manipulation. At the moment of commencing the operation, a certain quantity of strong quick lime must be flaked in the least possible quantity of water. This is the surest and most speedy method of reducing it into fine powder. The lime is to be sifted, in order to separate the pieces which do not fall down, and of the powder seven grammes are to be weighed. The quantity of cheese above indicated is to be taken and pounded till it has the appearance of salve, and with this the seven grammes of lime are to be mixed, and the mixture well agitated, which loses its consistence, and acquires that of hot new made glue.

On the other hand, whiting in powder is taken, and added to the water and the charcoal, and the whole accurately mixed. This mixture may be passed through an open sieve, in order that it may be reduced to a liquid homogeneous paste.

The

The mixture of lime and cheefe is then to be added, and carefully mixed with that of the whiting and charcoal diffused in water. The colour is then finished.

The doses here pointed afford a colour too thick to be used *Dilution,* in this state. We must therefore add to the mixture a quantity of water necessary to communicate the degree of fluidity desired; but this addition must not be made till the moment before it is used, for I have observed that the colour keeps better the less water it contains.

Two hundred and ten grammes of water added to the *Surface covered.* colour, made as before prescribed, afford the necessary quantity for exactly covering a square surface of 1,948 meters, or one toise or fathom. It may, however, be easily apprehended that the doses of water, and even those of charcoal, may be varied to a certain point, according to the judgment of the operator.

When a red or yellow colour is desired, similar to that *Colour.* which is used for pannels, ceilings, &c. I substitute, instead of whiting and charcoal in the foregoing process, the colouring matter which I intend to use. The following are the preparations which appeared to me to afford the most solid colour most capable of supporting the encaustic and wax (*l'encaustique et le cirage.*)

Well dried curd or cheefe	-	144 grammes
Slaked lime	- - -	7 grammes
Colouring matter	- - -	200 grammes

If, instead of the ocre, we substitute charcoal in a state of *Shining effect by* high division, lamp black, for example, we obtained a black *wax or sugar.* colour, which may be used with success to blacken the leather of trunks.

When the colour is dry, if it be desired to give it a shining appearance, it is covered with two coats of a solution of white wax in the essential oil of turpentine. When this kind of encaustic is dry, the wax may be polished by friction with a clean cloth. This preparation has the advantage that it does not scale, but resists water a little, properties which the compositions usually applied to this purpose do not possess.

If, to the mixture of cheefe, lime and lamp black, a small quantity of dried sugar or honey be added, a black colour is obtained, which dries speedily, and is sufficiently shining to

be used like the foregoing. The experiments I have made on this object, though satisfactory, are not yet perfectly equal to my wishes.

The paint is mixed according to the preceding instructions, and the necessary degree of fluidity for painting a first or second coat is given by means of water, the dose of which must be determined by circumstances and judgment. The whole is then covered with the common encaustic, and the operation is finished as usual by rubbing.

Advantages of
this new paint.

I shall not enlarge more amply on the utility of the paint which I here propose. Every observation which has been made by Cadet-de-Vaux may be applied to this, because the various changes I have made in this process do not deprive it of any of its advantages; but, on the contrary, render it more valuable. The solidity of the painting by means of cheese is at least equal to that of painting with milk and resin; but the former is more beautiful, less disposed to become yellow, is more simple, and must necessarily cost much less than the paint in distemper with milk, and still much less than the resinous paint with milk. Water does not spot it, nor even leave any trace after it is dried, an advantage which size painting is very far from possessing.

It may be kept
very well, or
made into cakes.

This paint with cheese may be kept very well, particularly when it does not contain much water. I have several times formed it into cakes, which, when pounded after their entire desiccation, formed, by the addition of a very small quantity of cheese and lime, a colour as solid as that which had been newly made. This experiment shews how much the export of this colour manufactured in agricultural districts may become advantageous in the way of trade.

How far this or
any other paint
can be a pre-
servative against
infection.

With regard to the property which the resinous paint with milk possesses of depriving walls of infection by its application upon surfaces penetrated with putrid exhalations; as this effect is purely mechanical, we may by analogy infer that painting with cheese must answer the same purpose, because it is sufficiently adhesive and fluid completely to stop the pores of the stones, plaister, and wood, to which it adheres no less strongly than the resinous paint with milk. But this property appears to me of little real utility. The processes which Citizen Guiton has given in his work on disinfecting the

the air, may be applied to the case mentioned by Cadet-de-Vaux, and answer the purpose with infinitely more speed and perfection. It appears, therefore, that those methods only ought to be used in such cases. For the fumigations operate of themselves, and without the assistance of a workman; whereas the painter of an apartment or infected chamber must necessarily expose his health, and sometimes even his life.

It only remains, after having thus endeavoured to simplify the process which Cadet-de-Vaux first brought to perfection, that I should express my wish that the advantages it really possesses might engage the manufacturers of paper hangings to adopt its use. The inhabitants of the country, who must naturally be more strongly impressed with its advantages than those of towns, will, no doubt, be the first to avail themselves of it. This application may at least assist us in saving an annual tribute, which our manufacturers pay to foreigners for animal glue or size. If cheese could hereafter be used as a substitute in block printing, I should think myself happy to have contributed one step towards the perfection of an art no less useful than agreeable.

Suggestion that it may be used in block printing of paper hangings.

XII.

Description of an Hydraulic Bellows for a Smith's Forge. By
Mr. J. C. HORNBLLOWER.

To Mr. NICHOLSON.

S I R,

I SEND you a sketch of a smith's bellows a little out of the common way. Its application to my purpose was suggested by an acquaintance I had by the large machines of that sort erected at Willy Furnace, by the late Mr. Isaac Wilkinson, father to the present Mr. John Wilkinson, about forty years since, and where circumstances or inclination have taken the lead, I have adopted the principle occasionally in this form.

Small hydraulic bellows for a forge.

What I have principally in view is, to mention to you a very striking difference between the effect of this bellows, and a common leathered 30 inch bellows in the same shop. The leathered bellows throws considerably more air to the fire, and

Its effect compared with common leathered bellows.

its nozzle compared with this, is as ,73 to ,60 in diameter, but it does not produce so great an effect in bringing on the heat, and the voice of this is so great as almost to drown that of the common one. The only difference in other respects is, that in the hydraulic bellows the pipe goes underground for about eight feet, and the conducting pipe of the other comes down about the same distance from the shop above.

If any further particulars are necessary for your comment on this subject, they are at your service.

I am, SIR,

Your very obedient Servant,

J. C. HORNBLOWER.

East Row, City Road, Feb. 12, 1802.

DESCRIPTION. Plate XII.

Description of
its structure and
operation.

A. The plunger, or working part of the bellows, 18 inches square within, which receives the air by a valve in the hinder part opening inwards, which at the stroke by the rockstaff E, throws it down the tube indicated by the dotted lines, which has a valve opening into the reservoir D, whence it is led to the tuyere by the pipe P. Length of the plunger 20 inches, stroke nine inches. Diameter of P three inches; of the nozzle 0,6 inches.

The whole is placed in a pit or cistern, having water sufficient to rise to the lower end of the tube where the valve hangs; this tube is the only communication between the upper part and the reservoir D: when as much water is poured in round the working part over the wash boards, as will rise within five inches of the upper edge of them, the bellows is ready for use. The little frame work serves to keep it from rising, and affords a convenient support for the balance and the rock staff.

I should observe, that the area of the pit or cistern ought to be at least twice as much as that of the plunger A*.

* From the pressure of other business, it has not been in my power to visit this manufactory, in order to ascertain the cause of the difference here stated; but I shall give the facts more particularly in the next number.

W. N.

XIII.

On the Practicability and Advantages of a general System of Rail Roads, and the Means of carrying the same into Effect. In a Letter from RICHARD LOVELL EDGEWORTH, Esq.

To Mr. NICHOLSON.

S I R,

MANY years ago I formed the project of laying iron rail-ways for baggage waggons on the great roads of England; but having consulted several of my friends, who were eminent mechanics, so many objections were started, that I for some time despaired of success. One great objection arose from the vast expence of massive rail-ways, and the continual cost of repairs. To obviate this difficulty, it occurred to me to divide the weight that is usually carried upon a single waggon into four or five portions, and to place them upon four or five small carriages; these carriages linked together would be as easily drawn as the same load upon one waggon. In pursu-
 The public advantage of rail roads long ago stated by the author,
 with models, &c. to the Society of Arts; viz. in 1768.
 Experiment in 1788.

ance of this idea, about the year 1768 I presented models of three such carriages to the Society for the Encouragement of Arts and Manufactures, who for this and other inventions in mechanics, honoured me with their gold medal; the date of which, and the journal of the Society may ascertain the early claim which I have to this invention. In 1788 I constructed four carriages with cast iron wheels, truly turned and supported upon friction rollers; these were shewn to several eminent persons, and were employed upon a temporary moveable wooden rail-way for a considerable time, in carrying limestone for the improvement of land. A variety of accurate experiments, and some useful improvements in this mode of carriage were made with these machines, which it would take up too much of your valuable work to detail. I shall mention only one idea, which appears to me so practicable, that I beg a place for it in your Journal, which will secure to it the most extensive circulation here, and on the Continent.

I propose, that by way of experiment iron rail-ways should be laid on one of the great roads, to the distance of ten or twelve miles from the metropolis, upon something like the following
 Plan for the commencement of a public rail-way. Four roads; two for

heavy carriages,
out and home,
and two for light.

lowing plan: four rail-ways should be laid on the road, raised on sleepers of stone, so that their upper surface should stand about four inches above the road. They should be made hollow from the bottom upwards, for strength and to save expence broad at bottom, and rounded at the top, to prevent the lodgment of dirt and dust. On these should run light waggons, each containing not more than one tun and a half weight.

The carriages to
be drawn stand-
ing on platforms
or cradles adap-
ted to the rail.

I have mentioned four rail-ways. The two inside roads should be appropriated for waggons, and the two external rail-ways for coaches and chaises, &c. The left hand rail-way invariably to be followed by each species of carriage on its own road; so as to prevent the possibility of any carriages meeting on the same rail-way. By appropriating the exterior tracks to light carriages, those which wished to pass others might turn off upon the waggon road, and resume their proper place after they had gone by the carriage they wished to pass. Now to accommodate coaches and chaises, &c. to these rail-ways, I would have them carried, wheels and all, in cradles or platforms; which should have wheels adapted to the rail-ways. By these means no alteration would be necessary in any of the carriages commonly used; but the horses of any coach or chaise might, as soon as they had got out of town, walk up an inclined plane into the cradle or platform, and draw their respective carriages after them: the horses should then walk out at the farthest end of the platform, upon the road belonging to the rail-ways. They would then draw the chaise not upon its own wheels, but upon the wheels of the platform or cradle in which the *chaise* should be detained.

Expected rate of
travelling, 12
passengers, six
miles an hour by
one horse, &c.

For stage-coaches similar platforms should be provided, and in these six inside and six outside passengers might travel at the rate of six miles an hour with one horse. Hackney, or gentlemen's chaises might go at the rate of eight miles an hour with one horse, without interruption or delay.

Hills avoided.

Where hills intervene, new roads must be made following the course of streams that wind between the hills, a moderate acclivity would not obstruct the progress of these carriages, that is to say, a rise of one foot in ten.

Numerous be-
nefits from this
scheme.

Every person conversant in these subjects, must know how much within bounds I speak with respect to the ease of draught upon rail-ways. The saving of horses and their food, the saving of wear and tear of carriages, the increased distance to
which

which horses could travel in a day, the freedom from dirt and dust, the security by night, the ease with which the sick and infirm might be transported from place to place, are all obvious considerations; but the chief convenience of this project arises from the mode of receiving and transporting on rail-ways every carriage now in use *without any change in their structure*, so that a traveller may quit and resume the common road at pleasure. To enumerate all the advantages that would arise from such roads, is unnecessary in this slight sketch; the intelligent reader will probably perceive many that are not even hinted. It is self-sufficient to lay the general idea before the public; the contrivance and economy of the different parts of such a project require long and minute details, which must be reserved for another stage of the business. If such a plan should have a fair trial, it might lead the way to farther speculations.

In this plan the carriages require no alteration.

It is not impossible by *slight circulating chains*, like those of a jack running upon rollers, to communicate motion between small steam-engines, placed at a considerable distance from each other; to these chains carriages might be connected at will, and when necessary they might instantaneously be detached. What a prodigious saving of expence might be thus effected? If the freedom and facility of intercourse, which has been obtained by good roads and canals, be, as Adam Smith asserts, one of the great causes of our national wealth, how far might this freedom and facility of intercourse be extended by the perfection of the scheme, whose outlines I thus lay before the public.

Draught by steam engines.

Every great project requires time for consideration; time accustoms the public mind to new views, and what at first appears too distant and unattainable by *time* becomes familiar and practicable.

The detail and reception of every great project requires time, &c.

Mechanics will not fail to comment on what appears in such a respectable publication as yours. You will not, Mr. Editor, hesitate to give your own opinion; you will at least be certain, that whatever objections are raised will be treated with candour, and replied to without enthusiasm, by

Your humble Servant,

RICH. LOVELL EDGEWORTH.

Edgeworth Town, Ireland.

XIV.

*Description of the darkening Apparatus for Telescopes by Means of Fluids. By WILLIAM HERSCHEL, L. L. D. F. R. S. * with an Engraving. Plate XI.*

Construction of an apparatus for viewing the sun through a coloured fluid. **A B**, Fig. 1. is a square trough, closed at the two opposite ends **C D**, by well polished plain glasses. It will hold any liquid through which the sun's rays are to be transmitted. **E** is a small spout, and **F** a handle; so that any portion of the liquid may be conveniently poured out, when the rest is to be diluted.

The trough is made to fit into the open part of the skeleton eye tube, Fig. 2. resting on the bottom **G**, and being held in its proper situation by the sides **H** and **I**, the end **K** at the time of observation is put into a short tube fixed to the Newtonian telescope, and may be turned about so as always to have the open part **H I** horizontal.

When the eye-piece Fig. 3. is screwed by its end **M** into the skeleton tube at **L**, Fig. 2. and the trough, Fig. 1. with any liquid to be tried is placed in the open part **G H I**, the sun's rays will come from the small mirror of the telescope to **K**, and passing through the plain glasses **C D**, inclosing the liquid, will enter the eye-piece **M**, and after the necessary refractions come to the eye at **N**. Any other single or double eye-piece of different magnifying powers may be screwed into **L**, instead of the piece Fig. 3; and the liquid may easily be tempered so as to intercept a proper quantity of light to suit every eye-glass which is in use, and thus to render the inspection of the sun perfectly convenient.

* *Philos. Transf.* 1801, p. 362, mentioned at page 21 of our Journal, but in that Number there was no room for the Plate.

XV.

On the Effects of the Respiration of the Nitrous Oxide; particularly an Instance in which the Excitation of the System produced unpleasant Symptoms. In a Letter from Mr. JAMES STODART.

To Mr. NICHOLSON.

S I R,

THE first opportunity I had of breathing nitrous oxide was in the month of June last, in company with Mr. Davy, in the laboratory of the Royal Institution. My curiosity had previously been much excited by what I had read and heard on the subject. I began breathing rather sceptically, but my doubts were soon removed. A slight degree of giddiness was followed by a pleasing thrilling and sense of warmth over the body; but not being used to breathe through a tube, and at the same time a little alarmed, I suffered a small quantity of common air to pass into the lungs, and by thus diluting the gas its powerful action was suspended. This first attempt increased my desire to breathe it in a pure state; and a few days afterwards I had another opportunity, in the company of the same gentleman. After exhausting the lungs by a forced expiration, and compressing the nostrils, I began breathing as before. The air tasted distinctly sweet; the slight giddiness was, as before, quickly succeeded by sensations very difficult to be described. I nearly lost sight of all sensible objects, and felt as if in a most delightful dream. On recovering from this trance-like state, my first feeling was certainly a sentiment of pride or disdain.—I could with difficulty descend to notice the objects around me. This emotion was succeeded by an irresistible propensity to muscular action, in which I indulged myself, by walking or rather stamping about the laboratory. It was in the morning that this experiment was made, and during the remainder of the day I felt highly exhilarated. In the evening I again breathed a quantity of the gas with nearly the same consequences. I found it impossible to resist the strong propensity to active exertions. At night I went to bed as usual, and after sound sleep I awoke in the morning more than usually cheerful.

Effects of breathing the nitrous oxide.

Taste of the gas. Giddiness.

Delirium.

Recovery.

Irresistible propensity to muscular action.

No depression followed.

Other trials.

I have lately prepared and breathed the gas at different times, and the effects were always pleasurable. One circumstance I wish to notice. A pain in the right side of my face and head, which for some weeks had been very troublesome, was certainly at first increased, after breathing four quarts of the gas. The pain, however, gradually lessened, and in about an hour was quite gone, nor had I any return of it either during the remainder of the day or following night. From this I began to suspect that the gas had been instrumental in some manner in removing the pain. Some symptoms of its return during the following day induced me to give this new agent a further trial. With this view I prepared six quarts of the gas, and an hour before my bed-time I breathed it. I was soon wholly under its influence—totally lost to all sensible objects—all was visionary. I fancied a number of people in the room; imagined musical sounds; and the apartment appeared illuminated with varied coloured lights. A friend who was with me thinks I remained in this state a full minute after dropping the breathing-bag. My first enquiries were wild and incoherent; but I gradually recovered my usual temper of feeling, slept well during the night, and awoke free from pain in the face. I have felt very little of it ever since. Whether the nitrous oxide was the removing cause or not, I shall not take upon me to determine. I used no other means; nor do I know whether any other person has breathed the gas under similar circumstances. A better acquaintance with this most extraordinary agent would probably lead to important and useful discoveries.

Pain in the face mitigated and removed.

Striking phenomena of deranged perceptions. Numbers of people—musical sounds—illumination of coloured light.

Gas breathed at the Royal Institution.

Since writing the above, I have again breathed the nitrous oxide in a very pure state at the Royal Institution, and was as usual lost in pleasure. On recovering, I signified a wish to know the state of my pulse, and was told it was above 140. This was on Saturday the 13th, about three o'clock. I continued under the strong influence of the gas as to muscular action, &c. during the remainder of the day; but awoke early next morning with feelings very different to those I had formerly experienced. I felt a tremor, soon became faint, and this faintness increased so much, that for a short space of time I was as if sinking into nothing. I was certainly under considerable alarm. A mouthful of water recovered me from the apprehensions of fainting. For some hours afterwards I remained

Usual effects. Alarming consequences next day.

remained in a very low state, during which I am certain that I repeatedly tasted the gas. But my mind was now perfectly tranquil, and at times I had feelings analogous to those I have sometimes experienced during the time of breathing the gas itself. During the whole of this and following day I felt depressed, with occasional slight giddiness; and as these feelings still continued, on the Tuesday morning I consulted Dr. Garnet, who considering the excitability of the system to have been exhausted by too powerful a stimulus, directed a cordial medicine and a moderate quantity of wine, the good effects of which I soon felt. It required a few days, with nourishing diet, to recover my former strength and spirits. I never intend again to breathe the gas in so large a quantity. I remain much at a loss to account for the effects produced by the last dose, so contrary to all my former experience; more especially as Mr. Davy does not think the dose was at all extraordinary in quantity, and the gas was not different from that usually prepared. It has stood over water for a day, and was breathed at the same time by Mr. Davy and another gentleman with no unusual consequence.

Extreme depression and occasional giddiness.

Medical treatment.

I am, dear SIR,

With much respect,

Your obedient Servant,

JAMES STODART.

Strand, Feb. 19, 1802.

P. S. I prepare the gas from the nitrate of ammonia; am particularly careful not much to exceed 400 degrees of heat, and have always suffered it to stand some hours over water before it is used. I procure the salt in a very pure state from Mr. Accum.

XVI.

Remarks on the Processes for clarifying Liquids. By CITIZEN
PARMENTIER*.

THE name of clarification is commonly given to a process by means of which liquids are deprived of such foreign substances as affect their transparency.

Clarifying is a process of some importance.

This operation, however simple it may be in appearance, deserves nevertheless to be particularly attended to, especially when we consider the advantages it affords in the chemical and pharmaceutic arts. From these motives, I have thought it might be useful to communicate some general notions respecting the process.

Various methods.

It is not my intention to develop in this place the different methods made use of to obtain this purpose, nor to shew at length the effects they produce with regard to each of the objects submitted to the operation. It will be sufficient simply to point out the principal phenomena attending operations of this kind.

Object of the process.

The purpose to be answered, is, to clear the fluid from such bodies as, without being dissolved, remain suspended, and impair its transparence and limpidity: but these bodies sometimes are separated by repose or filtration; in other instances by the action of the air, of heat, of light, of motion, and of fermentation; and again in other instances by means of agents, which, by uniting the scattered particles in the liquid intended to be clarified, frequently change its nature, and no longer allow them to remain in their former state. We will begin our examination by attending to spontaneous clarification.

Spontaneous clarifying of fluids

This takes place only when the particles to be separated are decidedly of a less or greater specific gravity than that of the fluid in which they are suspended. In this case they may unite at the bottom of the fluid, or at its surface, and form a magma, which is very easily removed if the separation has been complete. After this the fluid possesses all the transparence which can be desired, and the most accurate filtration will add nothing to its clearness.

* Annales de Chimie.

This method of clarifying is sometimes subject to inconveniences, of which the principal are, that it requires much time, and tends by this delay to favour the formation of new products, which, by changing the composition of the fluid itself, no longer presents it, independent of the abstraction of the bodies which affected its clearness, the same as it was before its clarification. We find a very striking example of this kind when we consider what happens in the spontaneous clarification of the juices of plants or fruits. These juices when newly expressed are always turbid; they nevertheless become gradually clear; but their nature is not then entirely the same: they contain products which would not have been found if they had been clarified immediately after the expression. For this reason also it is that the juice of lemons, of gooseberries, &c. when examined before or after their spontaneous clarification, are so different in their taste, their colour, and their domestic utility.

affords time for other changes to take place;

In general we may consider it as a certain fact, that all the fermentable fluids are liable by spontaneous clarification to the effects here stated, whereas they do not take place with respect to such liquids as are little or not at all capable of fermentation, and of which the transparency is affected only by the interposition of particles incapable of acting in any manner upon the constituent parts of the fluids themselves.

and is not therefore suited to fermentable fluids.

Thus for example: Water, alcohol, ether, oil, &c. which in their first state may not have been perfectly transparent, may easily become so by spontaneous clarification, without the least change ensuing in their composition; for when we examine them after clarification, we find them in the same state as other similar fluids which have not been subjected to that process.

But other fluids are well adapted to this treatment.

The second process for clarifying fluids consists in filtering them; but this operation can never be performed without the assistance of intermediate bodies, of which the very contracted pores admit only of the passage of the fluid, and retain all the particles which were before suspended in it.

Filtration.

The instruments of filtration are exceedingly various. Paper, woollen cloths, linens, cottons, carded cotton, sponge, sand, earth, pounded glass, charcoal, porous stone, &c. all these bodies may be usefully employed in the present operation;

Different kinds of filters

tion; but their nature and their purity must first be examined more particularly when the fluid to be filtered is of a saline nature.

require selection.

It is incumbent on the chemist to select from among the different filters, that which, by producing the clarification of the fluid in the best manner, shall not at the same time effect any change in its constituent parts. Now the choice to be made in this respect must be determined from the knowledge we possess of the nature of the fluid, and that of the kind of filter proper to be employed.

Paper

If the fluid be aqueous, vinous, alcoholic, or oily, paper may be used without inconvenience, provided it be of good quality. This last condition is absolutely indispensable, for without this the filtration would frequently prove defective.

acts mechanically,

We know that paper is a *mechanical* texture of vegetable fibres, which have undergone different preparations. The particles of this fibre, by intertwining, leave pores, the tenuity of which is always governed by the state in which the paste or stuff existed at the moment when it was converted into paper. If this tenuity was considerable, the pores become speedily obstructed by the sediment deposited from the liquor under filtration, and at this period the filtration ceases. On the contrary, if the pores be very open, the filtration is made with rapidity in an incomplete manner, because at the same time that the fluid passes through the pores it carries along with it the most minute particles which are suspended, and there are only the coarser which remain on the surface of the filter.

The great art is therefore to choose such paper as has its pores of a requisite magnitude to admit the fluid intended to be filtered, without suffering any of the particles which produced the turbidness to pass through.

Different kinds of paper for filtering;

Two sorts of paper are found in commerce, which nearly produce this effect; and though they are not always as perfect as might be desired, these have hitherto been preferred to every other. The one, which is of an imperfect white, is known in France particularly by the name of *papier Joseph*. The other is a kind of grey paper, less coarse than that which serves for wrapping up cheap goods. Neither of these have any size.

The

The white colour of the *papier Joseph* shews that it has been manufactured with a superior material to that used for the grey paper. The fluids which have passed through it are always very transparent, but it has the inconvenience of being easily torn, and its pores are soon obstructed, so that its filtration is not effected with dispatch.

The grey paper may be used for a long time also in producing clear fluids. But as the paste out of which it was fabricated was not as pure as that of the *papier Joseph*, it always communicates a disagreeable taste to the fluids, owing to the solution of the foreign matters it contains. On this account precisely it is that certain fluids, such as whey, wine, ratifia, and other liquids for beverage, when filtered through the grey paper, have always an odour and taste, which delicate organs soon recognize. And hence it is that among those fluids some of them are more susceptible of alteration than when they have been filtered through the *papier Joseph*.

The nature of the paper requires more particularly to be considered when saline solutions are to be filtered. If the grey paper be used, it frequently happens that part of its substance is dissolved by the saline liquor, so that it becomes less pure than before. This inconvenience, which is not so perceptible when the *papier Joseph* is used, may be still further diminished, by using the precaution of employing such filters only as have been previously washed by repeated filtration of boiling water. The exact pharmaciaan ought to be always provided with filters thus washed, in order to have recourse to them upon occasion. Josse, so distinguished in pharmacy, and to whom we are indebted for many important observations, has found the advantage of these instruments under a multitude of circumstances. He has, among other observations, remarked, that whey clarified and filtered through (*du papier raisin*) may be kept for more than fifteen days, by filtering it daily, which could not be done if it had been filtered through the common grey paper, even though previously washed.

By an effect directly contrary to this, different juices and plants are preserved transparent, and in good condition, without passing to the acid state, in consequence of their having been daily filtered through the grey paper. It was observed merely that their colour became more intense on the first days, and that they afterwards became insensibly discoloured.

But

Various precautions.

But while we consider the nature of filters, their form and situation are no less important. In order that a filter of paper may produce its full effect, it must not adhere by its whole surface against that surface which supports it, for if this were the case the filtration would be soon stopped. This inconvenience is avoided by dividing it in different directions. But as the folds are soon flattened, some prefer placing between the support and the filter, straws or simple tubes of glass. I must confess that this last method has not always succeeded with me, and that I have most commonly observed, that the folds made in filters produce nearly as much effect as the pieces of straw and tubes. In Germany (and in England) they have funnels grooved or fluted within for this use.

Whatever may be the precautions which have been taken, a period will arrive at which the filtration becomes slow, and at length totally stops. This effect takes place when the pores of the paper are so much obstructed, that they no longer admit the passage of the fluid. Sometimes the filtration may be prolonged by giving a slight circular motion to the funnel; but this effect is of short duration, and there is no other remedy but to change the filter itself. It seems that there has not yet been found any means of remedying this inconvenience, which is common to all filters whatever.

Filters of woollen;

We have before observed that filters are made of woollen cloth, of piece goods, and of carded cotton. The woollen were formerly much used, and were even the first filters adopted. They were formed into the figure of a cone, of which the base was kept open by an hoop that was fixed in a frame with supporters. This kind of filter is still used to filter ratafias, as it may be rendered very capacious, and is susceptible of receiving a large quantity of fluid at once; but it affords little, and it is therefore necessary to wait a long time before the fluid passes clear; for which reason it is seldom used, excepting when no other apparatus can be procured.

and their uses.

Nevertheless, when the filtration of syrups is required, woollen cloths are used; but then instead of giving them the form of a cone, the operator simply fixes his cloth in a square frame, fastening the four corners upon pins disposed for that purpose. The boiling syrup is poured in the middle, where it always forms a kind of concavity, and frequently after a few minutes the liquid passes very clear.

This filter may be used for many other fluids, particularly those of an aqueous nature, which do not contain potash or soda in solution. For if they were only slightly alkaline, the filter would be soon destroyed, and the filtered liquor would not possess the requisite qualities.

Linen or cotton cloths, and paper, are commonly used for alkaline liquids, and they succeed very well, particularly when those fluids are not too concentrated. With regard to carded cotton, it is reserved to filter such fluids as are of considerable price, or very scarce.

Linen or cotton cloths, or paper, to what liquids applied.

This filter is made by introducing carded cotton into the tube of a glass funnel, where it is lightly pressed together with a glass rod so as to form a kind of stopper; after which the fluid intended to be filtered is poured into the funnel. The filtration takes place drop by drop and after the first drops are separated, those which follow are always clear. The essential oils may be very well filtered by this method, without any fear of that loss which would necessarily follow if the other filters before spoken of were used.

Carded cotton.

The acids, particularly those which are concentrated, can only be filtered through pounded glass; but care must be taken not to use this substance till after it has been washed several times, first in a large quantity of water, and afterwards in an acid, in order to deprive it of the earthy substance which the acids might dissolve.

Filter of pounded glass;

Glass filters may be very well constructed in a funnel. The great art in order that they may produce the effect, is to fix in the first place some fragments of glass in the tube, and afterwards to have others which are smaller, and this process must be continued, constantly diminishing the size of the fragments until the powder lies to the thickness of three or four inches, the last stratum of which must be very finely pulverised.

how constructed.

This kind of filter operates so well, that in less than an hour it is possible to filter through a funnel of middling size several kilograms of acid.

Sand is also very commonly employed to clarify water for domestic uses. Sandy springs are in fact true filters, of which the effect is more certain, in proportion as the layers of sand are so disposed, that the water upon them may be obliged to pass through the sand successively, and leave those bodies which injure its transparency.

Filtration by sand.

The

The art of constructing fountains or springs with sand is not yet carried to the degree of perfection it is capable of, and though it may seem to be an object of little importance, it well deserves to fix the attention of philosophers.

Observations.

Experience also shews, that filters or fountains of sand cannot be used with success but for a limited time. It is necessary to change the sand frequently, or at least to wash it, in order to deprive it of the earthy heterogeneous substance, deposited by the water, and which when accumulated to a certain point would not only oppose or diminish the filtration, but also communicate to the fluid a flavor, which is the more disagreeable in proportion to the length of time it remains in contact with it. Nothing is more easy, as is well known, than to deprive river water of the earth which it suspends, and which obscures its transparency. For this purpose it requires only to be left a few hours in an earthen vessel uncovered, because the action of the air is necessary to effect this precipitation speedily and completely.

(To be continued.)

SCIENTIFIC NEWS.

*Extract of a Letter from Brunn, in Moravia, dated
January 3, 1802.*

Tellurium is
asserted to be
antimony only.

A CHEMIST of Vienna pretends to have observed, that the new metal *tellurium*, discovered by Klaproth, and generally acknowledged as such, is nothing else but *regulus of antimony*: an observation which, according to my own experiments, has much probability.

Water said to be
decomposed by
magnetism.

Galvanism is at present a subject of occupation of all the German philosophers and chemists. Tromsdorff has burned various metals by means of a pile of 150 plates; and at Vienna a discovery has been made, that an *artificial magnet*, employed instead of a Volta's pile, decomposes water equally well as that pile and the electrical machine; whence (as they write) the *electric fluid*, the *galvanic fluid*, and the *magnetic fluid* are the same. *

* I applied the poles of a five bar magnet to two steel wires in the tube of water, having their extremities in the water less than one-tenth of an inch asunder, and perceived no effect.---W. N.

On

On the Muriatic Acid.

The reading of Mr. Chenevix's paper upon oxygenised and hyperoxygenised muriatic acid, before the Royal Society, was concluded on Thursday the eleventh. Chenevix on the states of the muriatic acid.

After a short account of the experiments that had been made before him, and particularly of the ingenious conjecture of Mr. Berthollet,* he states the means by which he has ascertained, that the acid contained in hyperoxygenised muriate of potash is muriatic acid, in a particular state of combination with oxygen; and the experiments by which he determined the proportion of those elements. From the quantity of oxygen and of simple muriatic acid contained in the salt, he proves that hyperoxygenised muriatic acid consists of

Oxygen	65
Muriatic acid	35
	100

From the proportions of the salt which is formed when a current of oxygenised muriatic acid is passed through a solution of potash, and which he found to be composed of the same elements, and in the same proportion as oxygenised muriate of potash would be, if at the very moment of its formation it had not been resolved into simple and hyperoxygenised muriate, he concludes that oxygenised muriatic acid is composed of

Oxygen	16
Muriatic acid	84
	100

From a number of experiments, which are stated at length, Mr. Chenevix imagines that the salts of the genus oxygenised muriate, do virtually exist; but that by superior affinities they are resolved into muriate and hyperoxygenised muriate at the very moment that the acid comes into contact with the bases.

He describes and analyses the salts of the genus hyperoxygenised muriate; and mentions the hyperoxygenised muriate of ammonia as an extraordinary instance of disposing affinities.

* Journal de Physique, 1788, page 217.

Chenevix on the states of the muriatic acid.

He obtained the alkaline salts pure by repeated crystallisations, and the earthy salts by boiling them with phosphate of silver.

He has examined likewise several of the metallic salts of this genus, and mentions hyperoxygenised muriate of silver, as strongly marking the difference between muriatic and hyperoxygenised muriatic acid. He ascribes to this salt, when mixed with combustible bodies, an expansive force, which he thinks he will be much within bounds, if he states to exceed five times that of any known detonating salt.

He concludes with an appeal to the chemical world, whether, in the present state of the science, it would not be more philosophical to say,

Muriatic radical, or some one word analogous to it, Muriatous acid, Muriatic acid,	}	Instead of	{	Muriatic acid. Oxygenised muriatic acid. Hyperoxygenised mu- riatic acid.
--	---	------------	---	---

and states the arguments in favour of either mode of appellation.

As a warning to those who would repeat his experiments he relates, in the course of his paper, an accident that happened in his laboratory to himself and to Mr. Vandier, by which the latter gentleman had almost lost his sight, and was wounded in the most dreadful manner.

—

A new Method of obtaining the Gallic Acid pure. By M. FIEDLER, Student in Pharmacy*.

As alumine has a great affinity with many vegetable substances, I inferred that this property might be applied to disengage the gallic acid from the extractive and the tannin which always adhere to it; and by that means to obtain the acid pure and easily crystallizable.

Experiment 1.—I dissolved two ounces of alum in boiling water; I filtrated and precipitated it by a solution of potash; I separated the precipitate, andedulcorated it till the water of the lixiviation no longer rendered the muriate of barytes turbid.

Solution of alum precipitated by potash.

* Journal de Chimie, par Van Mons. I. 85.

Experiment 2.—I infused, to a reduction of one half, an ounce of good gall nuts in sixteen ounces of water. The result was a brown infusion, which after many filtrations continued turbid.

Experiment 3.—I mixed with the preceding infusion the precipitate of alumine, and frequently agitated the mixture with a glass rod. The next day I filtered, and observed that the matter passed perfectly clear, which convinced me that the alumine had precipitated the extractive. I washed the precipitate with warm water, until the water no longer blackened sulphate of iron, after which I left it to dry.

Experiment 4.—As the alumine had evidently separated the extractive substance from the infusion of gall nuts, I could only suppose that the liquor of the filtration must contain tannin at the same time with the gallic acid. I ascertained the presence of the latter, by a solution of sulphate of iron; and to discover the former, I proceeded in the following manner.

Experiment 5.—I dissolved two scruples of isinglass in an ounce of water, and poured a few drops of this solution into the liquor of the gallic acid; they did not make it turbid in the least; which proved that it did not contain any tannin, which, with the gelatine, ought to have formed an elastic substance, insoluble in water. As the tannin was not discoverable in this liquor, there remained no doubt of its having combined with the alumine, which I ascertained in the following manner.

Experiment 6.—I digested a portion of the precipitate of the infusion of gall nuts with diluted sulphuric acid. It was entirely dissolved. The liquor passed clear through the filter, but coloured by the extractive matter. I dropped in a little of the isinglass solution, and immediately observed white filaments floating in the liquor, which by agitation formed into a mass, possessing all the properties of tanned glue; namely, of becoming elastic by heat, of softening by water, insolubility in alcohol, &c.

Experiment 7.—The filtered liquor, as well as the water of the lixiviation in the third experiment, of course held in solution nothing but the gallic acid. I concentrated the two fluids by slow evaporation, and obtained a salt in fine needles, which was the pure gallic acid.

Nut-gall infused in water.

The precipitate of alum, being added to the infusion, combined with the extractive part.

The clear fluid might contain tannin and gallic acid.

But, by the test of isinglass, it contained no tannin. Consequently the tannin was combined with the alumine of Exp. 3.

Precipitate of No. 3. was dissolved in sulph. acid, which seized the alumine, while the tannin was precipitated by mucilage.

The clear solution of gallic acid, Exp. 4. afforded fine crystals of gallic acid.

The Seven following Articles are Extracts of a Letter of CIT. VAUQUELIN to CIT. VAN MONS*.

1. *Discovery of the Chromate of Iron in France.*

Chromate of iron in France.

The chromate of iron has been found in abundance in the department of Var: we can now prepare any quantities of this metal, and study its properties in detail more than we have hitherto been able to do. Above all, we can compose in a direct way the chromate of lead, which is a very interesting object in painting. The chromate of iron may also be used to form a beautiful green on porcelain or artificial stones.

2. *Discovery of the Emerald.*

Emerald in France;

In a mineralogical tour which Cit. Lelievre, member of the Council of Mines has just made, he has discovered a quarry of emeralds, which are so abundant, that they are used in the country to pave the roads. They are found in the environs of Limoges mixed with granite, often without any regular form, and sometimes crystallized, but their colour and transparency are not beautiful.

3. *Discovery of the Neutral Phosphate of Iron.*

and neutral phosphate of iron.

Cit. Lelievre has likewise discovered in the same place a mineral sufficiently interesting, namely, a perfect phosphate of iron, that is to say, that the iron is intirely saturated by the phosphoric acid, a combination which had not hitherto been found in nature; it has a red brown colour, is semi-transparent, and has a foliated texture.

4. *On the Zoonic Acid.*

The supposed zoonic acid is the acetous;

Cit. Thenard has just finished an examination of the zoonic acid, in which he appears to have demonstrated that it is nothing but the acetous acid combined with a peculiar animal matter.

5. *On the Cobaltic Acid.*

and the cobaltic acid is arsenic.

Cit. Darracq has read a paper to the Institute, in which he shews that the acid found in zaffre by Cit. Brugnatelli, and which he named the cobaltic acid, is absolutely nothing but the arsenic acid.

You see that by degrees the number of chemical substances diminishes, which is a great advantage to the science.

* Journal de Chimie, par Van Mons. I. 218.

ACCOUNT OF BOOKS OF SCIENCE.

Elements of Chemistry. By J. Murray, Lecturer on Chemistry, &c. Edinburgh, 1801. Longman and Rees, London.

THE author of this work appears to be well acquainted with every thing at present known relative to the science of chemistry. He follows the classification of substances according to the order of their simplicity, and has given a digested, concise, and perspicuous detail of every important fact concerning their chemical relations. Murray's elements of chemistry.

The view he takes of the present state of our knowledge respecting the important subject of heat is clear, candid, and satisfactory. On this, as well as on other controverted points, after stating the leading arguments on both sides he presents his own opinion where requisite, in the modest form of a query. On the whole, this work may be considered as a safe and clear guide to the student of chemistry; and as an useful course previous to the study of the more extensive system of Fourcroy. B. B.

A Syllabus of a Course of Lectures on Natural and Experimental Philosophy. By Thomas Young, M. D. F. R. S. Professor of Natural Philosophy in the Royal Institution of Great Britain. Quarto, 193 pages. From the press of the Royal Institution, where the work is sold, and at Cadell's, in the Strand, London.

This syllabus appears to be one of the most complete and accurate outlines of science which has been hitherto published. It is divided into four parts, and each of these into subordinate sections, consisting of paragraphs regularly numbered. I cannot pretend in this notice to enter into any discussion of the numerous subjects which, in the nature of things, must be very concisely stated in such a work, and of which the illustrations must be sought in the lectures of the learned professor; but some intimation of the arrangement and objects of instruction will be gathered from the titles as follow. Part I. Mechanics. Of induction; motion; composition of motion; centre of inertia and of momentum; accelerating forces; central forces; projectiles; motion in given surfaces; collision Young's syllabus of philosophical lectures.

Young's syllabus
of philosophical
lectures.

and energy; pressure; equilibrium; rotatory power; preponderance; practical mechanics in general; geometrical instruments; perspective; statics; friction; passive strength; architecture; carpentry; wheel-work; union by twisting; economy of motion; time-keepers; raising weights; friction wheels; carriages; compression and extension; penetration and attrition; trituration and demolition. Part II. Hydrodynamics. Of hydrostatic equilibrium; floating bodies; specific gravity; pneumatic equilibrium; hydraulics; resistance of fluids; hydraulic machines; pneumatic machines; sound; harmonics; properties of light; dioptrics and catoptrics; optical instruments; physical optics; nature of light. Part III. Physics. Of the fixed stars; the sun; primary planets; secondary planets; comets; laws of gravitation; sensible effects of the celestial motions; practical astronomy; geography; tides; general properties of matter; heat; electricity; magnetism; meteorology; natural history. Part IV. Mathematical Elements. Of quantity and number; space; the comparison of variable quantities; the properties of curves; practical rules and tables.

The whole work is beautifully printed, and such demonstrations as occur are distinguished from the narrative or enunciation by a smaller type. The figures are extremely neat. A fifth part is mentioned as probably hereafter to appear, containing a catalogue of the best authors.

MR. BLAIR'S POPULAR LECTURES.

Mr. Blair has recently commenced a course of popular lectures, at the Bloomsbury Dispensary, for the information of scientific persons, amateurs of natural history, and students in the liberal arts. He proposes to explain and illustrate the following subjects, on Tuesday evenings, at eight o'clock:

On the component parts of the body—the bones, cartilages, and ligaments—muscles, and muscular action—the integuments and membranes—brain, nerves, and sensation—the heart and vascular system—the blood, circulation, and absorption—glands, secretions, and excretions—respiration and animal heat—digestion, nutrition, and growth—utero-gestation, and parturition—the eye, and phenomena of vision—functions of the ear, nose, and mouth—physiognomy, beauty, and the passions.

JOURNAL

NATURAL PHILOSOPHY, CHEMISTRY,

AND

THE ARTS.

APRIL, 1802.

ARTICLE I.

Experiments on the Transmission of Heat downwards through Mercury and through Oil contained in Vessels of Ice; by which those Fluids are proved to be proper Conductors of Heat. By Mr. JOHN MURRAY, Lecturer in Chemistry, Materia Medica, and Pharmacy, at Edinburgh. Communicated by the Author.

IN a former Memoir * I related several experiments made with the view of determining the question, whether fluids are capable of conducting caloric, and stated the sources of fallacy by which any strict conclusion from these is invalidated. The experiment calculated to determine this question with greatest certainty is that of heating a fluid downwards by bringing a hot body into contact with its upper surface; but in making this experiment a source of error is always present in the conducting power of the vessel in which the fluid is contained. When the upper portion of fluid has its temperature raised by the application of a hot body, part of it must flow towards the sides of the vessel, and give out part of its caloric; the solid

Review of the experiment of transmitting heat downwards through a fluid.

* Philof. Journal, I. 165. where by mistake the author's titles are erroneously given.---W. N.

matter of the vessel must convey more or less of this caloric downwards, and communicate it to the fluid beneath; and thus caloric may appear to be conducted to a considerable depth, though the fluid do not actually possess a conducting power. In any usual mode of performing this experiment, this source of fallacy cannot be entirely obviated; nor can its effects be estimated with such accuracy, as to determine precisely how far any observed rise of temperature in a fluid is to be ascribed to its operation.

Error from the vessel, avoided by forming it of ice.

It occurred to me, that this error might be completely avoided by employing a hollow cylinder of ice to contain the fluid. Suppose a thermometer to be placed horizontally within such a vessel, its bulb being in the axis of the cylinder, and covered with a fluid at the temperature of 32° . Let a hot body be brought in contact with the upper surface of the fluid, or even immersed in it, but still so as to be at some distance from the bulb of the thermometer; if the thermometer rise it may be concluded that the fluid has a conducting power, since the caloric could reach the bulb in no other mode. Caloric does not pass through fluids by radiation; it is easy to perform the experiment so as to prevent the thermometer from being heated by any motion of the fluid, from immersing the hot solid; and lastly, no caloric could be transmitted by the sides of the vessel, since ice cannot have its temperature raised above 32° , and cannot therefore communicate any temperature above that to a contained fluid. The conclusion therefore seems undeniable, that if in such an experiment the thermometer rise, caloric must be conveyed to it by the fluid interposed between it and the heated solid.

If the thermometer do rise the fluid is a conductor.

Whether the opposite conclusion may be affirmed, in case the thermometer do not rise?—No.

It seemed doubtful, however, whether the converse of the proposition would hold equally good. If the thermometer were not to rise, would this prove that the fluid is a perfect non-conductor? It is not evident *a priori*, whether a fluid contained in a vessel of ice is capable of being heated above 32° , or at least could convey caloric above that temperature to any perceptible distance, even allowing it to have a conducting power. Suppose that the heated solid is immersed in the fluid, the particles in contact with it will be heated, and will form an ascending current which must flow towards the sides of the vessel. The ice will abstract the excess of caloric from these heated particles, and they will return to the temperature

perature of 32° . It appears doubtful, therefore, whether any part of the fluid beneath the heated solid, supposing it to be capable of conducting caloric, can have its temperature in such a situation raised; and hence it appears uncertain, whether from the circumstance of the thermometer not rising in such an experiment, it could fairly be concluded, that the fluid is a perfect non-conductor of caloric.

There are also reasons, however, which render it probable, that any conducting power in the fluid if it do exist, may be discovered by an experiment of this kind, by the rise of the thermometer. Supposing the fluid to possess such a power, it is sufficiently possible that the caloric may be conveyed from the heated solid through the interposed fluid, (especially if the quantity of the fluid be small) to the thermometer, more quickly than it can be cooled by the ice. Two facts render probable this supposition. 1st. Ice is an imperfect conductor, and therefore absorbs caloric slowly from another body. If a piece of ice be thrown into water at 40 or 50° , a considerable time elapses before the temperature of the fluid is reduced to 32° ; and 2dly. The celerity with which a hot body gives its caloric to a cold one, is, *ceteris paribus*, proportioned to the difference between their temperatures. If the hot body, for example, have a temperature 100 degrees higher than the cold one, it will communicate caloric to it with much more celerity, than if it were at a temperature only five degrees higher. This cause operates in the present experiment. The difference between the temperature of the heated solid suspended over the thermometer, and that of the fluid interposed is very considerable, and it will therefore give caloric to it rapidly. On the other hand, the difference between the temperature of the particles of the fluid that are heated, and that of the ice with which they come in contact must be much less, and therefore they will part with their caloric more slowly. From this circumstance, independent of the slowness with which ice absorbs caloric, the communication of caloric in this experiment must be more rapid than its abstraction; and therefore if the fluid do possess a conducting power, the thermometer must be heated.

In reflecting on this subject it seemed even possible, that the fluid might be cooled so much more slowly by the sides of the vessel, than it was heated by the solid suspended in it, that the

If the heat be given out faster than the ice can absorb it, the thermometer will rise if the fluid be a proper conductor.

Whether the stratum of heated fluid can extend below the hot body, and thus heated

raise the thermometer?—Not unless the vessel conducts; which in this case it does not.

heated particles might accumulate, and perhaps at length come in contact with the bulb of the thermometer, raise its temperature, and thus give the appearance of the fluid possessing a conducting power, though it had none. I was soon satisfied, however, that this could not be the case. Supposing the caloric to be ever so slowly abstracted from the hot particles, still the stratum of fluid directly heated, can never extend beneath the solid which is the source of the caloric. It is from it that the current of heated particles ascend, and they descend by the sides of the vessel, where their temperature may be reduced partially or intirely. But this descending current cannot proceed lower than the point where the ascending one commences, and of course no part of the fluid which has thus been directly heated can reach the bulb of the thermometer. In glass vessels this is not the case, because in these caloric is given out by the sides of the vessel, even beneath the heated solid, which is suspended within it. But in an ice vessel there is no communication of this kind, as it cannot conduct caloric at any temperature above 32° .

But if the thermometer rises, the fluid conducts; and if not, the fluid is probably a non-conductor.

The experiment then which has been stated is subject to none of these sources of fallacy. If the thermometer rise, there can be no doubt that the fluid conducts caloric. If it do not rise, it may be concluded, if not with equal certainty, at least with the greatest probability, that it has no conducting power.

A vessel was formed of ice.

A quantity of water was frozen in a tin mould, so as to form a hollow cylinder A, Pl. XIII. Fig. 2. the diameter of the cavity of which was three inches, and the depth $3\frac{1}{2}$ inches, the thickness of the ice forming its sides and bottom, being $1\frac{1}{2}$ inch. A thermometer B was introduced into it horizontally at the depth of one inch, the bulb being in the axis of the cylinder, and was frozen in, so that the vessel was capable of containing any fluid. It is evident that by pouring a fluid into this ice cylinder, so as to cover the bulb of the thermometer to a greater or less height, and by suspending in it a heated solid, any propagation of caloric through that part of the fluid beneath the solid, will be ascertained by the rise of the thermometer.

Water could not be used in these experiments, because it contracts by heat

For making this experiment with a view to determine the conducting power of fluids, water is altogether unfit, from the singular property it has of expanding instead of contracting in every reduction of temperature from 40° of Fahrenheit to 32° .

Suppose

Suppose the cylinder of ice to be filled with water at 32° , and a heated solid to be suspended in it, the portion of water in contact with the solid, will immediately have its temperature raised perhaps two or three degrees. But by this increase of temperature it is not expanded, but is contracted in volume, it becomes heavier, and must therefore sink in the fluid towards the bulb of the thermometer; it will be succeeded by another heated portion, a descending current must thus be formed, and the thermometer will have its temperature raised by the contact of particles which had been directly heated by the suspended solid.

Oil and quicksilver are not liable to this source of fallacy. It has been ascertained by Crawford and De Luc, that the diminutions of volume in these fluids from decrements of temperature are nearly uniform, or at least at any temperature necessary for performing experiments of this kind they contract with sufficient regularity, as is indeed sufficiently shewn by their use as thermometrical fluids.—With these fluids therefore the following experiments were made:

Experiment I. A quantity of almond oil was poured into the ice vessel, so as to cover the bulb of the thermometer one quarter of an inch. A small iron cup C, cylindrical, two inches in diameter, and flat in the bottom, capable of holding two ounces by measure, was suspended so as merely to touch the surface of the oil, and was filled with boiling water. This was preferred to a solid ball, as presenting a larger surface to the oil, and as it was more easy to ascertain the precise depth at which it was immersed. At the beginning of the experiment the thermometer stood at 32° . In a minute and a half it had risen to $32\frac{1}{4}$, in three minutes to $34\frac{1}{2}$, in five minutes to $36\frac{1}{4}$, in seven minutes to $37\frac{1}{2}$. At this point it became stationary, having risen $5\frac{1}{2}$ degrees of Fahrenheit's scale in seven minutes. The temperature of the water in the cup had in this time fallen to 96° . The thermometer, after remaining stationary at $39\frac{1}{2}$ for six minutes began to fall, and it continued to descend at the rate nearly of a degree in a minute and a half, till it returned to 32. At the conclusion of the experiment the sides of the cylinder at the upper part were partly excavated, the excavation was greatest at the surface of the oil, it became less as it descended, but it had taken place in a slight degree, even lower than the bulb of the thermometer,

near 32° , and would descend to the thermometer.

Oil and mercury do not contract by heat; at least about the temperature here mentioned.

Experiment I. Almond oil at 32° in the ice vessel was heated by water poured into a stationary metallic vessel slightly immersed in it. The heat descended to a thermometer.

Excavation of the ice.

meter, shewing that the fluid had been heated to this depth. The oil still covered the thermometer one quarter of an inch.

Exp. II. Repetition with a greater depth of oil.

Experiment II. The experiment was repeated, the oil covering the thermometer half an inch. The temperature was as formerly 32° , in three minutes the thermometer had risen to $32\frac{1}{4}$, in six minutes to $32\frac{3}{4}$, in eight minutes to 33, in 12, to 34, in 15 minutes to $34\frac{1}{2}$, at which it became stationary. In this experiment, therefore, the thermometer had risen $2\frac{1}{2}$ degrees in 15 minutes: it descended as slowly as in the preceding experiment. In a third experiment in which the thermometer was covered three quarters of an inch with oil, it rose only $1\frac{1}{2}$ degree in the same time.

Exp. III. Repetition with mercury. Speedier transmission of heat.

The same experiment was next repeated with quicksilver in a similar cylinder of ice. 1st. The quicksilver covered the bulb of the thermometer one quarter of an inch. The small iron cup was not suspended, but allowed to float on its surface, and was filled with boiling water gently poured in. The thermometer began to rise instantly: in one minute it had risen from 32° to 36° , it remained at that temperature, or at least with the increase of half a degree, for another minute, and then began to fall; in three minutes it had fallen to 35, the temperature of the water in the cup having fallen to 102. The thermometer continued to descend slowly, till it returned to 32° .

Whether the subsidence of the mercury from fusion of the ice can affect the conclusion?

In this experiment there is a particular source of fallacy, against which it was found necessary to guard. From the melting of the sides of the cylinder of ice at the upper part by the contact of the heated fluid, the diameter of the cavity is enlarged, and therefore the column of mercury must diminish in height. In the experiment with the oil this does not take place, because the water formed from the melting of the ice being heavier, falls by the sides to the bottom, and supports the column of oil at its precise height, the one circumstance counterbalancing the other, since as much ice as is melted, as much water is produced, and very nearly the same volume is occupied by both. It was accordingly ascertained by exact measurement at the end of each experiment with the oil, that it had not sunk perceptibly; in other words, the bulb of the thermometer remained covered with the same height of fluid, as at the commencement of the experiment. But with the quicksilver the case is otherwise; the water produced by the melting

melting of the ice floats on its surface, and hence from the enlargement of the diameter of the vessel, the height of the column of mercury must be diminished. It was therefore necessary to ascertain with accuracy, whether this diminution had proceeded so far, as that the particles of mercury which had been in contact with the bottom of the iron cup, and directly heated by it, had come in contact with the bulb of the thermometer. This was found not to be the case. At the end of the experiment the bulb was still covered with so much mercury that the cup floated freely; and it was ascertained in particular both by actual measurement, and by a gage frozen in the side of the cylinder, that the quantity of mercury covering it was still one-eighth of an inch deep. As therefore the cup merely floated on the surface, the part of the fluid *directly* heated by it could not have come in contact with the bulb. This was likewise clearly established by the phenomena of the experiment itself; the thermometer rose rapidly at the commencement of it before the quicksilver could have sunk sensibly, and it remained stationary at the end when the fall descent had taken place, although the water in the cup was still warm. On pushing it down so as to cause it to touch the bulb the thermometer rose rapidly, a proof that it had not previously been in contact with it. In this point of view therefore the experiment was unexceptionable, and those which follow were still less liable to any fallacy of this kind, as a larger quantity of fluid was interposed between the heated body and the thermometer.

Proofs that it did not.

2d. As much mercury was poured into the vessel of ice as to cover the bulb of the thermometer half an inch, and water at 212° was poured into the iron cup floating on its surface. The thermometer stood at 32, in one minute it rose to $32\frac{3}{4}$, in two minutes to $33\frac{1}{4}$, in three minutes to $33\frac{3}{4}$, it then became stationary, and in six minutes more began to fall. The quicksilver in the vessel was found to have sunk rather less than one quarter of an inch. The thermometer therefore at the end of the experiment still remained covered with one quarter of an inch of fluid.

Exp. IV. Repe-
tition with a
greater depth of
mercury.

3d. When the experiment was made a third time, the bulb of the thermometer being covered with one inch of quicksilver, the rise of temperature amounted to three-fourths of a degree.

Exp. V. and
still greater.

Variation of
the circum-
stances.

All these experiments were frequently performed, they nearly agreed, and the above are the average results. Every precaution was taken to ensure accuracy, in which I was assisted by several friends. They were likewise occasionally varied. In one instance the cylinder of ice was made so wide, that a small thermometer was placed entirely within it in a horizontal position, and covered with oil, but the result was nearly the same. In others a solid brass ball was suspended in the fluid instead of the cup with hot water, but without any material difference in the result. In constructing the vessel it was found necessary that the ice should be frozen hard, that it might contain the fluid without allowing any of it to transude; and in the experiment with the mercury the external mould of tin was allowed to remain round the ice cylinder to give it strength, and enable it to contain the mercury without any risk. This however could make no difference in the experiment, and the result was found to be the same when the tin was removed.

Development of
the process.

In all these experiments then, a rise of temperature in the thermometer took place, greater or less, proportioned to the quantity of fluid interposed between it and the heated body. From the nature of the experiment this rise could not be expected to be considerable, since the fluid when heated must quickly have had its caloric abstracted by the cylinder of ice in which it was contained. Hence at a certain stage of the experiment the thermometer became stationary, though the heated body suspended over it still retained a considerably high temperature, the communication of caloric to the fluid not being equal to its abstraction by the ice; and when the communication became less rapid than the abstraction, the thermometer began to descend. In all these experiments, however, even in those in which the largest quantity of fluid was interposed, the rise of the thermometer was unequivocal, and in some of them, considering the circumstances of the experiment, very considerable.

Conclusion. *The fluids were direct conductors of heat.*

For the sides of
the vessel could
not conduct:

This rise it appears to me impossible to ascribe to any other cause, than to a power in the fluid to conduct caloric. Any other that might be imagined can be proved not to exist.

Thus it is evident, that the sides of the vessel could not convey to the fluid in contact with the bulb of the thermometer, any part of the caloric it received. Ice in common
with

with any other solid may at temperatures below its melting point conduct caloric; but as it cannot possibly exist with a temperature above 32° , it cannot communicate any temperature above that to a fluid in contact with it, and consequently it could not contribute in the above experiments to raise the thermometer above that temperature.

The experiment was performed in such a manner that no motion was occasioned in the fluid capable of conveying any part of it directly heated to the bulb of the thermometer; and indeed the regular, and in some of the experiments, the slow rise of the thermometer is inconsistent with the supposition of caloric being communicated by any cause of this kind. neither was the fluid agitated;

It has been proved, that any current produced in the fluid by the contact of the heated solid could not be the mean of conveying caloric; for if the fluid be supposed to have no conducting power, since the sides of the vessel are likewise incapable of communicating any increase of temperature, the portion of fluid beneath the surface could not possibly be disturbed by a heated solid merely resting on that surface. Even if the solid were immersed to some depth in the fluid, it is only from the sides and under part of it that a current could rise, and of course no part beneath that level could be affected. nor could any heated current descend;

It has likewise been shewn, that the rise of the thermometer cannot be ascribed to the contact of particles directly heated by the solid, and reaching the bulb from the sinking of the column of fluid by the enlargement of the diameter of the vessel from the melting of the ice; 1st. because in the experiment with the oil this sinking did not take place, the water produced supporting the oil at the same height; and 2dly. because even in the experiments with the mercury, the diminution did not take place to that extent which would have been necessary to have brought the particles which were heated on the surface of the fluid into contact with the thermometer, as was proved by actual measurement, and by the phenomena of the experiment itself. nor did the mass of warmed fluid subside to the thermometer;

Lastly, the caloric which reached the bulb of the thermometer could not have been propagated by radiation, because caloric, it has been proved, does not radiate through transparent fluids; and it cannot even be supposed capable of passing by radiation through an opaque fluid as mercury. The last point is obvious, and is of itself decisive with respect to this objection. nor was the heat transmitted by radiation.

objection. But even the first, that caloric does not radiate through a transparent fluid, has been sufficiently proved by the experiments of C. Rumford. I shall add one of a similar kind made with the particular apparatus used in the preceding experiments, which appears to me sufficiently decisive. The thermometer in the ice cylinder was covered with oil one quarter of an inch, and the cup was suspended over it in such a manner that the bottom of it, though near to the surface of the oil, *did not touch* it. Boiling water was poured in, the thermometer rose scarcely one degree in five minutes, and did not rise more in any longer time. It has been shewn that when the thermometer was covered with one quarter of an inch of oil, and the cup filled with warm water, was suspended so as to *touch* the surface, it rose in seven minutes $5\frac{1}{2}$ degrees. Had this rise been owing to the communication of caloric by radiation, the variation in the experiment which has just been related, could not have produced any change in the result. The communication of temperature by the *conducting power* of the fluid, must be facilitated by the contact of the fluid with the heated solid, but the communication of it by *radiation* required no such aid, nor could it be promoted by it. The mere circumstance of the heated solid not touching the fluid, could make no difference with respect to the one, but must make the most essential difference with regard to the other, and the experiment clearly proves, that even through transparent fluids caloric does not radiate. The slight rise of temperature that took place, is owing to the caloric passing partly by *radiation*, and partly by communication by the medium of the air to the *surface* of the fluid, and from that it is conveyed by the conducting power of the fluid to the thermometer. The proof of this is, that even with mercury, a slight rise of temperature was indicated when the experiment was performed in the same manner. When the cup with hot water was suspended over the mercury covering the bulb one quarter of an inch, but not touching it, the thermometer rose one degree.

Experiments of radiation; with remarks.

Concluding remarks.

It may therefore from the whole of these experiments be concluded, that the observed rise of temperature was owing to the fluid conducting the caloric, since no other cause can fairly be assigned. I have not subjected any other fluid to experiment, because it was difficult to find any of a nature sufficiently different, which the ice would have been capable

of containing. But if it be proved that oil and mercury are capable of conducting caloric, it will be admitted as sufficiently probable that other fluids must have a similar power. Of these two, mercury it is probable, from these experiments, is the best conductor, as the rise of the thermometer took place in it much more rapidly than in the oil. That the temperature did not rise higher in it than in the oil, seems to have been owing partly to its greater mobility, by which its parts would move towards and from the ice with more celerity, and partly to its better conducting power, by which it would give out its caloric more quickly to the large superficies of ice with which it was surrounded. It was accordingly observed, that the sides of the ice cylinder were more excavated in the experiments with the mercury than in those with the oil.

Edinburgh, Feb. 27, 1802.

II.

Description of a new Escapement for Watches, invented by Mr.

JOHN DE LAFONS*.

THE inventor states, that since the perfection of chronometers consists more in the equality of impulse given to the balance than to any other cause, he has contrived the present escapement for giving such an impulse; with the additional qualities of locking the wheels without spring work perfectly safe, and unlocking them with less consumption of power than in any other escapement he knows, because the wheels do not bear against the locking with more than one tenth part of the whole pressure from the main spring, which last circumstance he conceives to be perfectly new.

The perfection of chronometers depends chiefly on the equality of the impulses given to the balance.

He remarks, that the equality of impulse has been effected with great ingenuity by Mr. Mudge and Mr. Haley; but at the same time he objects to the escapement of the former, on account of its extreme difficulty and expence, and to that of the latter, for its very compound locking. And he also re-

Escapements of Mudge and Haley.

* From the Transactions of the Society of Arts. 1801. A premium of thirty guineas was given by the Society to the inventor: I have not copied the letter press, as I wished to render the description rather more minute than was necessary in that place.—N.

plies

Description of a
new escapement.
Its parts.

plies to some observations which were made at the committee of the Society, which do not require to be stated here.

Plate XIV. exhibits the escapement, where the same letters denote the same things in all the figures. A is the scape-wheel, B a pallet lever on an arbor with fine pivots, having at its lower end, Fig. 1 and 2, a remontoire, or spiral spring, C, fixed with a collar and stud as pendulum springs usually are. H H represents the balance, having upon its verge K K, a pallet D, consisting of two arms, which carry a small roller moveable on fine pivots; and also certain other pallets E, represented more fully in Fig. 4, the plan of which parts is seen in Fig. 1, at E and D. F is an arm which serves to move two locking pallets *a* and *b*. It is continued beyond the center of motion, in order that it may balance itself in all positions, and at the part most remote from the balance there are a couple of studs and screws to adjust and bank the quantity of motion. The last mentioned pallets have their faces, portions of circles, and they move on an arbor with fine pivots, as may be seen at Fig. 2 and 4, in which figure also it is to be observed, that the arm of the locking pallets is formed into a triple fork, the branches of which are exposed to the action of two pallets E before mentioned.

Performance of
the escapement.

1. The scape wheel winds up a lever and spring; and is caught by a detent. But the re-action of the spring lever renders the hold of the detent exceedingly light.
2. The balance unlocks the wheel which lets go the lever, and this strikes a pallet on the balance arbor.
3. In its return the balance again unlocks the wheel, which again winds up the lever, (No. 1, 2, 3, &c.)

From the above description, and the consideration of the figures it will be apprehended, that, supposing the maintaining power to urge the wheel A forward, and the balance to be set in motion by external means, the lever pallet B will be wound up to its position in Fig. 1. by the tooth 1 of the wheel, at which instant the tooth 3 rests upon the pallet *a*. Suppose the balance to move in the direction of the small arrow near D, the verge pallet D will just pass the end of the lever pallet B, at which moment one of the two unlocking pallets E will carry before it the arm F, and unlock the pallet *a*, and consequently the wheel will drop with its tooth 4 upon *b*, and the lever pallet B will be set at liberty by the advance of the tooth 1, to act upon the balance by the pallet D, until B is stopped against the tooth 2, as seen in Fig. 5. By this means the balance receives the same invariable impulse at every second vibration. In its return the opposite unlocking pallet takes the other external arm of the fork of the locking pallets, and by that means unlocks *b*. The wheel immediately drops forward, almost through the space of one tooth,

tooth, so that the tooth 1, Fig. 5, falls upon the pallet *a*, while the tooth 5 winds the lever pallet B again into the position exhibited in Fig. 1. And the balance upon its return receives a second impulse under the circumstances already detailed.

It remains only to be shewn in what manner the middle prong of the fork is employed. Its use is to secure the locking of the pallets *a* and *b*. When the unlocking is performed by the action of either of the pallets *m m*, Fig. 4, the middle prong falls into the small notch in the roller *n*, which lies between those pallets; and when the unlocking is performed, and either *a* or *b* has received its tooth, the arm F renders it impossible it should be accidentally disengaged, because that arm is prevented from returning by the circular face of *n*, past which it could not return at all, if the notch or excavation were not made to permit to pass at the proper time.

Lastly, as the pallet lever B always rests against one of the teeth of the wheel A, the pressure against the pallets *a* or *b* may be rendered extremely light, so as to deduct scarcely anything from the momentum of the balance at unlocking.

Fig. 3. exhibits a simpler mode of construction, in which a spring is substituted instead of the pallet lever with its spiral. The inventor remarks, that he should prefer this construction for a clock, but that the disadvantage from the weight of the spring in different positions is obvious*.

III.

Remarks on the Processes for clarifying Liquids. By CITIZEN
PARMENTIER.

(Continued from page 234.)

NEVERTHELESS, though the use of the filter for water intended to be drank is of high antiquity, we must confess that the fountains constructed for this purpose not only deprive them of the earth which rendered them muddy, but likewise

Filtered water is infpid, because deprived of gas.

* Some account of Time-pieces and Escapements are given in the Philosophical Journal, Quarto Series, I. 56, 429. II. 50. III. 187, 342, 416.

of a super-abundance of air with which they are sometimes impregnated, and gives them that lightness or briskness, which is found in the waters of the Seine in a greater degree than in any other known stream. The proof of this is, that by repeated filtrations we may render water flat, heavy and unwholesome.

Thus when the specific gravity of the water of the Seine is required to be determined, it is adviseable to take it from the river at the time when it is limpid, or leave it to clear by subsidence, and not to take that in preference which has been filtered; for though this operation renders waters clearer, it changes them remarkably, by depriving them, as has been observed, of the air which they contain in super-abundance.

I know a person whose palate was so accustomed to water, that he could distinguish by the taste water filtered through sand, from that which had not been so filtered. The latter appeared to him more sapid and lighter; which proves, no doubt, the privation of this air, a fact which may also be very easily ascertained under the receiver of the air-pump.

The filter cannot render salt water fresh.

Certain individuals, who are interested to maintain the contrary to what is here asserted, have affirmed, that if water were continually forced to pass through 18 feet of sand of gravel upwards, it would be purified not only of heterogeneous matters, but completely purified that is to say of its salts: This prejudice was such, that in order to support the notion the following reasoning was offered:

If these filters be sufficient to deprive water of its air, why should not the same operation be equally proper to deprive it of the salts with which it is charged; but no attention was paid to the circumstance that these salts held in solution in the water, being specifically heavier, pass along with it through the smallest apertures, whereas air being specifically lighter, and existing in a different state from that of the salts, is easily separated. And this process of application was proposed to be applied to sea water in order to render it potable. The operation has even been announced to the government as new and ingenious. It consisted in a filtration effected by force in a direction contrary to that of gravity.

But the union of saline matters with water has not a purely mechanical division. They are not interposed as some philosophers have pretended, but perfectly dissolved in water, and possess

possess the same fluidity. These salts consequently become capable of passing through the finest filters. No other means but evaporation is therefore adopted to separate water from the saline substances which it holds in solution, and consequently distillation alone can produce this desirable effect. But to return to the general effects of filtration:

Independently of the filters here mentioned, water is also clarified by means of the stones called filtering stones. Of these there are several kinds. They are very porous, because sand enters into the greatest part of their composition. These stones being excavated are filled with water. The fluid gradually insinuates itself through their pores, and appears on the external surface in the form of drops of considerable clearness, which fall into a vessel placed beneath.

The filtering stone;

It is necessary that these stones should be previously washed by filtration of a large quantity of water. It is observed, that even for several days the water acquires a disagreeable taste, owing to the foreign matters dissolved by this fluid in its passage through the stone. Water thus clarified cannot be fit for use until it passes through intirely deprived of taste.

how managed.

In general the filtering stone, though highly extolled, is a bad instrument to procure good water; for the filtration is made very slowly, and very often stops altogether, if the inner and exterior surfaces of the stone be not rubbed from time to time with a coarse brush, to detach the earth which the water deposits. To these inconveniences no doubt it is, that we ought principally to attribute the difuse into which this kind of filtration is fallen.

It is a bad contrivance.

It now only remains, that we should speak of the other processes which are used to give that perfect limpidity to several fluids, which they can never acquire by spontaneous clarification or by filters, whatever may be their structure.

Clarifying without the filter.

Though it is true, that the remarkable opacity of some fluids is owing to the interposition of particles not dissolved, but merely suspended in consequence of their extreme division; it is also certain, that under other circumstances the defect of transparency depends intirely upon the incomplete solubility of one or more bodies contained in these fluids, so that in order to give them the desired limpidity, we must necessarily have recourse to the methods which increase the solubility of the substances in question, or effect its total separation.

Opacity from imperfect solution;

removed by certain additions.

Albumen, gelatine, the acids, certain salts, lime, blood, and alcohol, may in many cases concur to operate the clarification of certain fluids, for which the common filters would be insufficient. Nevertheless, these agents cannot be indifferently used, and the preference given to one rather than the other always requires to be determined from a knowledge of the fluid to be clarified. Accident has shewn for example, that two handfuls of marle reduced to coarse powder, and thrown into the fruit in the press, clarifies cyder and small cyder.

Albumen and gelatine used in fining wines, &c.

The effect of the albumen and gelatine is principally seen in vinous liquors. For this reason also they are used in fining wine, that is to say, in producing that bright clearness which they can seldom acquire, and preserve by simple repose. In this case it is sufficient, that one or the other of these two substances should be dissolved in a small quantity of water, and the solution mixed with the cold wine. A short time afterwards a kind of net-work is seen to form itself through the whole fluid, and soon afterwards this net-work contracting in all directions, collects all the foreign substances, and carries them to the bottom.

In some instances an acid is added.

In other instances it is necessary to heat the fluids with which the albumen has been mixed, and in these cases the clarifying is effected at the instant the mixture begins to boil. Most syrups are clarified by this process, and hitherto no other process has been discovered to produce a better effect. It has also been observed that albumen alone is not always sufficient to clarify liquids, even though they be heated sufficient to cause them to boil; but that it is necessary to assist its action by means of an acid, or salt with excess of acid. In proof of this we may offer the clarification of whey as an example.

In fact, it is proved that whey, in which albumen has been mixed, does not admit of the coagulation which carries the cheesy matter along with it, unless a portion of acidulous tartarite of potash or vinegar be added at the instant the boiling begins.

It may also be conceived that the quantity of acid requisite to be added in this case always bears relation to the state of the fluid, and that it would be absurd to pretend to fix the dose in an invariable manner.

Fresh

Fresh cream is advantageously used to clarify spirituous liquors. One or two spoonfulls for each French pint or English quart are sufficient to produce this effect, without heat, in the course of a few hours. But as in this clarification there always remains some cheefy particles suspended in the fluid, on account of their great subtilty, it is necessary to complete the process by subsequent filtration.

Cream used to clarify spirits.

Lastly, there are fluids which, in order to become clear, require only to be heated nearly to the boiling point. These are principally such as owe their opacity to substances which cannot be completely dissolved, unless the temperature of the solvent be raised considerably above the natural state. Many saline solutions are in this case, and those who are busied in chemical researches have frequent opportunities of observing them.

Mere heat.

Most of the juices of plants newly expressed may be partly clarified by heat. The chemist is therefore in the habit of recurring to this method with respect to the juices which, on account of their density and viscosity, are not capable of being filtered.

Clarifies the juices of plants, &c.

It frequently happens that a very slight degree of heat, applied to expressed and filtered juices of certain plants, will render them at once turbid; in which case the flocculent matter that floats in the liquid settles at the bottom of the vessel. This substance was considered by Rouelle the younger as the vegeto animal matter of wheat; but I shewed, in 1772, that it is a substance similar to the white of egg: which proves that we were authorized at that period to reckon the albumen among the products of the vegetable kingdom.

Vegetable albumen precipitated.

I must insist on an important observation, that in general it is necessary to separate the magma which is formed in liquors clarified in albumen, particularly when in order to concentrate these fluids it is necessary to evaporate them by boiling. Without this precaution we shall see the same magma dissolve, and the fluids become more turbid than they were before the clarification. For a like reason it is that soups, which have not been skimmed in time, always retain a cloudy and unpleasant appearance.

Caution again re-dissolution of the albumen.

Though the use of albumen to clarify the juices of certain vegetables is considerable, it is not, however, exempt from inconvenience. One of these inconveniences is, that it

In what cases fining with albumen is hurtful.

changes the nature of these fluids so much, that their medical properties are partly destroyed. What happens to certain pharmaceutical preparations, such as decoctions of medicines, when white of egg and heat is used to clarify them, is well known; for, in that case, they become almost ineffectual, if care has not been taken to double the proportion of ingredients which enter into their composition. Lewis has observed, that this operation deprives the syrup of diacodium of all its medical properties.

Such are the observations which I have thrown together respecting clarification. My design in communicating them has been to prove that this operation, though simple in appearance, cannot be practised without some skill and attention; and that among the number of processes commonly used, several afford results less satisfactory than others. It is necessary, therefore, to determine with regard to the choice of methods according to the nature of the substances made use of. I have confined myself to a clear narration of the facts; others may direct their attention to the explanations of the mode in which these substances operate.

IV.

On the Discovery of the Arseniates of Copper and of Iron. By a Correspondent.

AN article * of the Decade Philosophique (30 Nivose), giving an account of the first trimestre of the tenth year of the French Republic, says, that Citizen Vauquelin has enriched the catalogue of mineral bodies by the discovery of two new substances, arseniate of copper and arseniate of iron. I am far from imputing to this able analyst the desire of attributing to himself any discovery to which he has no title; but the French chemists, whether from ignorance or intention, pay so little regard to the discoveries of others, that it becomes the duty of every friend of science to point out their violations of historical justice.

In the year 1786, Mr. Klaproth examined an ore from Cornwall, and found it to be arseniate of copper. Schlotheim published a description of it in 1790.

True statement
of their history.
Klaproth.

* By Cit. Lacépède, Secretary.

In

In the first volume of the *Annales de Chimie*, page 195, Proust, there is an imperfect sketch of an analysis of arseniate of iron by Mr. Proust.

In February, 1801, the Count de Bournon presented to the Royal Society a very long and able account of a great number of varieties of these ores, which he had the good fortune to procure from Cornwall. This paper was followed by Mr. Chenevix's chemical analysis, which proved the accuracy of the Count's description.

The most extraordinary part of the paragraph in the French Journal is a confession, that the specimen examined by Cit. Vauquelin had been sent to the Ecole des Mines of Paris by the Count de Bournon. That gentleman never did send any until his account and Mr. Chenevix's had been made public. Cit. Vauquelin's paper must have been read at the National Institute between September 20 and December 20, 1801, six months at least after the communication to the Royal Society. Hence we see the justice of attributing that discovery to the French chemist.

In the *Journal de Physique* of Brumaire, tenth year, there is a paper of Dr. Karsten, of Berlin, upon the same subject but which deserves no notice, further than as it regards the history of this substance.

I am, SIR,

Your humble Servant,

A CORRESPONDENT.

V.

On the Nature and Preparation of drying Oils; with a View to the Improvement of such as are used by Artists, as Vehicles for painting.* By Mr. TIMOTHY SHELDRAKE.

EXPRESSED oils, considered with a view to the painter's use of them, may be divided into two kinds; first, such as are capable of drying in some circumstances by themselves, and always with certain additions; and secondly, such as cannot be made to dry by any means whatever.

Drying oils, and such as do not dry.

* Transactions of the Society for the Encouragement of Arts, for 1801, page 209.

Drying oils;
linseed, nut, and
poppy.

Of the first, which I shall call drying oils, there are three in common use, linseed, nut, and poppy oil. The first is darkest coloured, and dries the soonest; the second is lighter, but does not dry so soon; and the third has least colour, and dries slower than either of the others.

Drying oils con-
tain mucilage.

By a process, which it is perhaps needless to describe here (*see Vol. xvii. page 281*),* I have succeeded in separating from each of those oils, a mucilage or gum, in a liquid state, and capable of mixing with water in every proportion, though, when thoroughly dry, it would not dissolve in cold water; but my experiments on this head were not carried to any great length. It is to be remarked that linseed oil afforded most of this gum, nut oil the next largest quantity, and poppy oil the least of all.

Olive oil con-
tains none:

Olive oil, when treated in the same manner, afforded none of this mucilaginous substance; whence I was led to conclude that the essential difference between the drying oils, and those which do not dry, consists in this:—that the latter either contains no mucilage or gum, or that it is so intimately combined with its other principles, that it cannot be separated from them in that peculiar manner which always takes place in oils which dry by themselves, or when mixed with colours.

Drying oil affords
a pellicle, which
dries first, &c.

If drying oil is exposed to the air, in a shallow vessel, and left at rest, a pellicle is soon formed on the top, and becomes externally perfectly dry. If this be removed, a second will be formed in the same manner; and if this experiment be repeated many times on the same quantity of oil, without moving or shaking the vessel, it will be found that the second pellicle will require more time to form it than the first, and so on, till it will be found difficult to get it fairly skimmed over in a considerable time. The same effect takes place, in a less visible manner, in every quantity of drying oil which is united with colours in a picture.

From this experiment it is to be concluded, that drying oils exert that faculty by throwing up their mucilaginous parts, which become solid when at rest, and in contact with the air.

* Or *Philos. Journal*, quarto, III. 345.

The ingredients added to oils to make them dry faster, viz. calces of lead, saline substances, earths or gums, are such as unite with and increase the quantity of those parts which float to the top, and form a skin, more or less dark, over the colours originally mixed with them. If we consider the nature of these ingredients, we shall be at once enabled to account for a fact universally known, viz. that in proportion to the strength of the drying oil used in painting a picture its colour becomes depraved. It will be injured and finally destroyed, by being kept in a damp situation, excluded from a free circulation of air, or placed under a glass.

When oils are rendered fictitious they deprave the colours; and how.

The desideratum is to prepare oil or other vehicle for painting, so that the colours, when mixed with it, shall not be debased under any of the above-mentioned circumstances. It must be so prepared or used, that it shall serve as a cement to unite and bind the colours, without skinning over them. It must likewise not contain those principles which always exist in the calces of lead, saline, or earthy substances, which from the first deprave the colours, and attract particles from the air, under peculiar circumstances, which increase that depravity, till at last the appearance of the colours is totally destroyed.

Oils for painting ought not to skin; nor contain changeable ingredients.

It is only among the resins or bitumens that we can expect to find a substance possessing the properties requisite to give to colours all the brilliancy and durability of which they are susceptible. My first attempts and experiments were made with solutions of mastic and sandarac in the painters oils; but though these compositions possessed more brilliancy than the common drying oils, they were liable to a considerable objection; for they did not dry readily, and when dry, were easily acted upon by all the common solvents for resinous substances, and on that account must be very deficient in durability, which is one of the most necessary qualities I wished to discover.

Resins or bitumens answer this character; Mastic and sandarac dry slowly, and are not durable.

The difficulty with which amber is in any way dissolved, suggested the propriety of trying that substance. Accordingly I dissolved it, in each of the painters oils, by Dr. Lewis's process, without injuring its colour; and this solution was made in the common way. It was much darker coloured in itself, but produced scarcely any difference in effect when mixed with colour. By experiments with each of these solutions I ascertained the following facts, viz.

Amber possesses superior qualities.

Every

- Experiments. Tints.** Every colour, and all the tints compounded from it, were more brilliant than corresponding tints and colours mixed with the best drying oils to be procured from the shops.
- Paintings shut up;** Colours mixed with amber, after having been shut up in a drawer for several years, lost nothing of their original brilliancy. The same colours tempered with oils, and excluded from the air, were so much altered, that they could scarcely be recognized.
- colours exposed to heat;** Colours tempered with amber were laid on plates of metal, and exposed (both in the air and close boxes) for a long time, to different degrees of heat, from that of the sun in summer to the strong heat of a stove, without being injured. It is needless to observe that oil colours cannot undergo the same trials without being destroyed.
- and to solvents:** These colours, when perfectly dried in any way, were not acted upon by spirit of wine and spirit of turpentine united. They were washed with spirit of sal ammoniac, and solutions of pot-ash, for a longer time than would destroy common oil colours, without being injured.
- They dry very well.** They dry as well in damp as in dry weather, and without any skin upon the surface. They are not liable to crack, and are of a stony hardness; whence it appears that this vehicle possesses every desirable property, and it is presumed may be a discovery of some importance to artists.
- Gum copal nearly as good as amber, and rather brighter.** Having succeeded thus far with amber, I tried the same experiments upon solutions of gum copal, which is nearly as hard and insoluble as amber itself. The result of these was the same as the former, except that with the copal the colours were something brighter than with amber. As it is extremely troublesome to dissolve the copal and amber, I tried those solutions of them in oil which are sold in the shops. When good, I found them to answer as well as my own. This is a great convenience, as many might be deterred by the difficulty of preparing this vehicle, who may willingly use it; as it is thus to be procured without that trouble.
- The Method of using the Solution of Amber or Copal, as a Vehicle for painting.*
- Instructions for the use of amber or copal as a vehicle for painting.** The cloth or other substance to be painted on, should be prepared with some colour fully saturated with drying oil; or it will be better done with the same vehicle to be used in painting,

painting. If it is not fully saturated, it will absorb some of the vehicle from the colours, which is commonly termed the colours sinking in.

All the colours which require grinding, should be previously ground in spirit of turpentine. All the pure parts should be tempered with such a quantity of the vehicle as will enable them to lie on the pallet. The white should be tempered as stiff as possible. All the tints should be made by mixing the colours so prepared without any more of the vehicle, but they should be diluted with spirit of turpentine, if necessary for working. Grinding colours, &c.

If the ground is properly prepared, and the above caution observed in tempering the colours, it will be found that all the dark colours in the picture will bear their full tone, and have a demi-transparency, which increases their native brilliancy, without the dingy appearance so common in ordinary oil-painting. The admixture of white increases the body of the colours progressively, till there will be left in the lightest parts, only so much of the vehicle as will bind the colours, and give them their full tone, but with very little of a shining appearance. When the picture is perfectly dry, it should be varnished with a mastic or similar varnish. Perhaps the best would be copal varnish made by solution in spirit of turpentine, or spirit of wine. Consequences or effects.

The rationale of this vehicle seems to be this: the amber and copal, when dissolved in oil, form a homogeneous mass, which dries by inspissating, instead of skinning over, like the common drying oils, which consist of heterogeneous parts, some of which separate and dry on the top. Observations.

As the amber and copal are not soluble in any of the menstruums which dissolve most resinous substances, pictures painted with them cannot be injured, if cleansed with those menstruums: and as they are extremely hard, and the most durable substances of their class, they protect the colours from every kind of injury, more effectually than any other known vehicle.

Conjectures to show that the foregoing vehicles were used by the older painters.
Lomazzo.

No. III. *Conjectures tending to show that the Vehicle which I have described, is similar in Principle, if not identically the same, as that used by several of the older Painters, who were eminent for their Skill in colouring.*

Lomazzo, an eminent painter, and pupil of Leonardo da Vinci, published a Treatise on Painting, in which it is mentioned that linseed or nut oil was generally used for painting: he likewise observes, that powdered glass was used as a dryer. As Lomazzo was blind when he published his treatise, he could have no motive for keeping any thing which he knew secret; whence it is to be concluded, that those oils were generally used for painting in his time, and that he knew of no exceptions to the practice.

Leonardo da Vinci.

In one part of L. da Vinci's Treatise on Painting, he mentions *nut-oil and amber*. As we know that amber gives peculiar brilliancy to colours, that L. da Vinci was peculiarly celebrated for the richness of his colouring, and are informed from his own writings that he was acquainted with solution of amber in nut-oil, it is to be presumed *that* was the vehicle he used. If this supposition is not to be admitted, we must believe that he knew how to dissolve amber in nut-oil (a process at that time both tedious and troublesome), without knowing the best use to which he could possibly apply it.

Leonardo's biographer says, "When he was at Rome, Leo X. resolved to employ him. Leonardo hereupon sets himself to the distilling of oils, and the preparing of varnishes to cover his paintings withal: of which the Pope being informed, said, pertly enough, that he could expect nothing of a man who thought of finishing his works before he had begun them. Leonardo therefore left Rome without having been employed."

I must beg leave to dissent from his Holiness's opinion. If my idea of Leonardo's vehicle be just, it was natural for him to begin the preparation of it as soon as he knew that he was to be employed as a painter: and as the spirit of that time led every one who made any useful discovery, to preserve it as a valuable secret, it was equally natural for him to account for his employment by saying that he was preparing varnishes. Whatever his secrets were, they remained unknown to the world till 1651, when his Treatise on Painting was published.

The next intimation of solutions of amber which I have obtained is from the works of Boyle, who gained much of his information from Italian chemists; whence it is evident that the knowledge of this preparation is of long standing in that country; and its use, if it was used at all in the arts, is to be sought for in the works of Italian artists.

Whoever examines the Venetian pictures with attention, considers that the best artists of that school were remarkable for the facility with which they worked, and reflects on some passages in Lomazzo, will be disposed to admit that the peculiar skill of the Venetian painters depended on three circumstances, viz. the colours they used, their method of using them, and the vehicle they worked with. Of the first, Lomazzo gives positive information: the second can never be known without information equally positive; but of the vehicle some knowledge may be obtained by way of analysis. Till that knowledge is obtained, I may perhaps be excused for hazarding the following conjectures.

If my experiments have not misled me, I am entitled to draw the following conclusions from them. Wherever a picture is found possessing evidently superior brilliancy of colour independent of what is produced by the painter's skill in colouring, that brilliancy is derived from the admixture of some resinous substance in the vehicle. If it does not yield on the application of spirit of turpentine and spirit of wine separately or together, or to such alkalies as are known to dissolve oils in the same time, it is to be presumed that vehicle contains amber or copal, because they are the only substances known to resist those menstrua.

I have been told, and some experiments of my own prove the information to be true, that the Venetian pictures, considered with respect to vehicle, are of two kinds: for some are extremely hard, and not at all affected by any of the above menstrua; others are similar in colour, but so tender that it is scarcely possible to clean them without injury, and in that respect are little superior to mere turpentine colours. The first, in consequence of the data which I have laid down, incur the suspicion of being painted with amber or copal, but how are we to distinguish with which?

As each of these substances resists equally the common menstrua, perhaps the distinction can only be made by ascertaining them.

Robert Boyle.

On the pictures of the Venetian school.

Superior brilliancy of colour from the vehicle,

which appears to have been amber or copal.

Attempt to make the distinction between them.

taining the date of the picture. For example:—if it is found to have been painted before copal was known in commerce, it may safely be said to have amber for its basis; but if it has been painted after that period, I know of no method of distinguishing which of the two was made use of. As copal could not have been known, as an article of trade, before the seventeenth century, it follows that all pictures painted before that period, and possessing the properties I have described, must have amber for the basis of their vehicle. As this exception necessarily includes all the Venetian artists of the first class, we are therefore authorised to conclude that, if the works of these artists can bear the test of the menstrua I have mentioned, amber was the basis of the vehicle with which they were painted.

Ancient recipe, in which turpentine was the solvent of copal.

I once saw a recipe for dissolving copal, said to have been brought from Venice towards the close of the last century. The process was, to melt Venice turpentine upon the fire, to add gradually copal powdered, stirring them together to be united in fusion, and afterwards spirit of turpentine, in order to dilute it to the consistence of varnish. I tried this process, but it did not succeed.

It was not common, but Chio turpentine.

Upon inquiry I found that the Venice turpentine of the ships was only common resin, dissolved in spirit of turpentine to a proper consistence; whence the cause of my failure was evident. Reflecting on the commercial pursuits of the Venetians in the fifteenth and sixteenth centuries, I was led to conjecture that the substance called originally Venice turpentine was the product of some country intimately connected with them. Pursuing this idea, I procured, with much difficulty, some Chio turpentine, repeated my experiment, and succeeded completely. Besides the property of uniting easily with copal, it had others that excited my attention. Common resins, if exposed to fire, burn with extreme fierceness and rapidity; but when some of this was laid on the point of a knife, and held in the flame of a candle, it melted and dropped down before it began to burn. It emitted a peculiarly grateful smell; was of a most beautiful pale gold colour; was more brilliant than any turpentine I had ever seen; and when diluted to the consistence of varnish, perfectly resembled in colour, a solution of copal which I made in spirit of turpentine with camphor.

This turpentine differs from the common sort.

I showed

I showed some of this to a gentleman who was conversant in such subjects. He told me that, when at Venice, he frequently rubbed pictures violently with his handkerchief, to try if he could discover what they were painted with; and when so rubbed, they smelt exactly like what I then produced to him.

Additional probability that the Venetians used it.

As I had previously perfected what I thought to be a superior vehicle, with which this could not vie in hardness and durability, I did not prosecute my experiments with this any farther; but as it unites rapidly with copal, and possesses all its visible properties, I may be permitted to conjecture that it would have similar effects when mixed with colours: and if there was any second, inferior, and common vehicle, similar in its visible properties to the last, and so much within the reach of the most ordinary painters, as to give their works one common mark with those of the first artists, it would be difficult to point out a substance more likely to afford it than this which must have been common in their own country, since its name is still attached to substances of the same class throughout Europe, though its real properties are now but little known.

This last compound less hard and durable than the former.

If this was the basis of the common Venetian vehicle, it might have been used with or without oil. If the latter, the works of the common Venetian painters must have been mere varnish painting: if the former, it must have been compounded with the oil, according to the principles I have already explained. I am inclined towards the latter opinion, from having heard an observation attributed to Bombelli, a celebrated Venetian painter, who said, "*That he wished his pictures to dry as fast as possible, that the oil in them might not rise to the surface, and turn yellow.*"

It might be used with oil or without.

To this conjecture it may be objected that turpentine and compounds from them do not dry well. I am not prepared to answer this objection, as I have made no experiments relative to it; but it certainly is not conclusive, as such compounds may not dry well in this country, though they may in the warm climate of Italy.

In the *Maniere d'imprimer les Tableaux*, published by Le Blond at Paris, 1740, is a recipe for the varnish he used on the coloured prints executed by him, in this country, before

Varnish of Le Blond.

he

he went to France. It is as follows:—"Take four parts of balsam of capivi and one of copal. Powder and sift the copal; and throw it by degrees into the balsam of capivi, stirring it well each time it is put in: I say each time; for the powdered copal must be put in by degrees, day after day, in at least, fifteen different parts. The vessel must be close stopped, and exposed to the heat of the sun, or a similar degree of heat, during the whole time; and when the whole is reduced uniformly to the consistence of honey, add a quantity of warm turpentine; *Chio turpentine is the best.*"

its durability
and excellence.

Le Blond's prints were long neglected, and are now forgotten. Whatever difference of opinion may prevail respecting them, there can be none respecting his varnish, as I have seen some of these prints in perfect condition, notwithstanding they had been thrown carelessly about for nearly sixty years.

His intelligence
probably from
Italy.

Le Blond was a pupil of Carlo Maratti. He died at a very advanced age, leaving behind him the character of an ingenious projector. It is probable that he might collect much information analogous to his pursuits during a long life; but it is more probable that he obtained much of it where he received his education. Thus, wherever we find notices of the use of these substances in the arts, they invariably lead us towards Italy, where they certainly were first known.

I have thus detailed the circumstances which impress me with a conviction that the vehicle I have offered to public notice is, in substance, the same as that used by the best colourists of the Italian schools. What impression the facts I have enumerated may make upon others I know not: but still the truth of my opinion must be determined by experience; for it would be of small consequence to prove that this vehicle was used in former times, unless it can likewise be made evident that it will be useful to the present race of artists.

Yours, &c.

TIMOTHY SHELDRAKE.

Strand, February, 1801.

VI.

On the Native and Artificial Sulphurets of Iron, by PROFESSOR
PROUST*.

IN a former memoir † I remarked, that the reason why the acids which easily dissolve the artificial sulphuret, do not exercise the same power on the native sulphuret, consists in an excess of sulphur in the latter, which art has not yet succeeded in combining with iron. Hitherto in fact, I have not presumed that our imperfect means could approach sufficiently near those of nature for us to hope to imitate the formation of pyrites. Accident, however, has lately removed this difficulty.

I heated, without any particular attention to the quantities, a mixture of about ten ounces of sulphur and of filings, in order to supply my laboratory; and judging by the colour that the quantity of sulphur was insufficient, I thought proper to add a new dose. In consequence of this, the crucible was made nearly red hot; but not to fusion, because it is more convenient for use to obtain it in the state of powder. When I afterwards tried to dissolve it in an acid properly diluted, I was somewhat surprized to find that it did not afford sulphurated hydrogen. It was to no purpose that I altered the strength of my acid, for I obtained no gas. This unexpected result shewed the possibility of forming pyrites by art.

Since pyrites becomes soluble as we have seen, only by depriving it of the sulphur which exceeds its point of saturation, it appeared to me, that I should first endeavour to restore its qualities by producing its first state from a similar excess of sulphur; and this in fact succeeded.

I mixed an indeterminate quantity of sulphur with four hundred grains of the pyrites of Soria, deprived of its excess by distillation, and I heated the mixture in a retort beside another, which also contained four hundred grains of pyrites in the crude state. My object in this last arrangement was to obtain a kind of thermometer, to prevent my giving too great a degree of heat to the first retort; that is to say, not to ex-

* Journal de Physique, Pluviose X year.

† Philos Journal, I. 109.

pose this second dose of sulphur, which a new attraction was to add, to that temperature which would constitute the first point of saturation with regard to iron.

At a given heat the super-abundance of sulphur was carried off by distillation, after which the two retorts being kept an hour longer at the same temperature, did not exhibit the slightest vapour of sulphur.

Regenerated pyrites.

The regenerated pyrites was pulverulent; a proof that it had retained no portion of sulphur beyond the point of saturation, otherwise I should have found it in a pasty state, having the figure of the retort.

Characters.

It had resumed the greenish yellow colour, which is that of crude pyrites when pounded, whereas its tinge was before dull and blackish like sulphurated iron, which is capable of affording hidrogen. Its weight was found to be five hundred and four grains, that is to say, the distilled pyrites had resumed twenty-six pounds of sulphur per quintal.

Proportions of parts.

Observations on the quantities; to prove that the artificial pyrites is the same as the native.

By inspecting the former memoir, we see that the mean product of two distillations, each consisting of four hundred grains of pyrites, was three hundred and eighteen for the residue, and seventy-eight for the sulphur, to which must be added three or four for what was carried away by the gas, so that in the quintal we have seventy-nine and a half residue, and twenty and a half sulphur. According to this report, four hundred grains of the residue, or distilled pyrites, ought to have taken only ninety-eight and a fraction of sulphur, whereas the result of our experiment gives one hundred and four. The difference being no more than one and half per quintal, may be ascribed to the inaccuracy of experiment, as well as the nature of the pyrites, which is not an homogeneous combination; for besides the clay and the sand, it often contains a small portion of oxide of iron, which may have caused the fixation of a somewhat greater quantity of sulphur than the loss it suffered by distillation.

Trial of the regenerated pyrites by acids; which did not dissolve it.

I afterwards examined my regenerated pyrites with a sulphuric acid of ten degrees by the areometer of Baumé, which acid dissolves the distilled pyrites very well; but I obtained only a few ounces of sulphurated hidrogen. I afterwards heated the mixture; it afforded a slight portion of gas, after which the pyrites remained without alteration. Long continued boiling was ineffectual for saturating my acid.

With

With the muriatic acid I succeeded in forming a small portion of gas; but its action soon ceased, and it was equally impossible for me to saturate the acid. It was of twelve degrees of the areometer, and the powder preserved its colour. The natural pyrites treated in the same manner does not afford the slightest suspicion of gas; but we must not overlook that art cannot give to its compounds that aggregate condensation which is one of the greatest obstacles to solution. Morveau and Fourcroy have given us very striking proofs in the resistance they found in dissolving the native oxides of iron and tin.

The aggregation of native pyrites in some measure defends it.

The pyrites not being, as I have observed, an homogeneous combination, it is evident that we could not expect to discover the true proportions of sulphur wherein iron could attract by these previous experiments; for which reason I made the following.

These experiments could not shew the proportions of sulphur.

In order to depend in the first place upon pure filings, we must begin by heating them gently, and for a considerable time in a glass retort. Under these circumstances, it is not a little remarkable to observe, that filings cleaned with the magnet, and kept in well-closed bottles, afford nevertheless a very ammoniacal water, and even muriate, if I am not deceived in the taste of the fluid which escapes.

Other experiments.

Iron filings afford ammonia.

One hundred parts of filings heated to a low red heat in a retort, and sulphur being let fall upon them, acquire an incandescence which was noticed even by the ancient chemists; but they do not become saturated. The increase is found to be only twenty or thirty parts. After pounding the product, then mixing it with sulphur, and exposing it to a red heat, a result is obtained, which weighs pretty constantly 159; but which, I think, may be set at 160, on account of the impurities of the iron.

Direct combination of iron and sulphur.

First degree of sulphurization: 60 parts of sulphur to 100 iron.

The product is iron sulphurated to the first degree. It may be fused, and even melts in the retort, if harpsichord wire be used, and maintains itself without alteration. Its colour is metallic, but dull and considerably different from the golden colour of the pyrites. In a word, it is the sulphuret which is proper to afford sulphurated hydrogen gas.

Its appearance.

In order to discover the excess which this sulphuret can still absorb, provided its temperature be less elevated, I treated two hundred grains of filings with the before-

Second degree, 89 sulphur to 100 iron.

tioned precautions, and obtained three hundred and eighteen grains of sulphuret. When taken out of the retort it was mixed with a new dose of sulphur, and heated beside another which contained crude pyrites. The super-abundant sulphur passed in distillation, and the retorts were kept for an hour at the same heat. The result of this operation was an artificial pyrites, weighing three hundred and seventy-eight grains. It was pulverulent, which proved that it had retained no more sulphur than its attraction could take up.

Its appearance
and habitudes.

Its colour was no longer blackish, but greenish yellow. When treated with the acids, its habitudes were precisely the same as those of the regenerated pyrites; and lastly, it differed from the native pyrites only by the want of that density which the latter received from their humid crystallization.

Consequences.

Recapitulation
of the facts,
with observa-
tions.

From the foregoing facts it follows, that iron can fix sixty per cent. of sulphur by a considerably elevated temperature. This proportion constitutes iron sulphurated to the minimum.

Sulphuret at
the minimum
10 sulph. + 6
iron.

By a lower heat it can also attract a quantity which is equal to the half of this weight; and this result is iron sulphurated to the maximum, or with ninety parts of sulphur. If this last combination be exposed to the temperature which formed the first, it returns to that state; that is to say, it returns to the minimum of sulphuration, by giving out all the sulphur it was capable of fixing above the proportion of sixty parts for each quintal of iron. Iron sulphurated to the maximum is the pyrites, and possesses all its properties excepting density.

Sulphuret at the
maximum 10
sulph. + 9 iron.

Pyrites reduced
to the minimum
by heat with iron
filings,
or by distillation,

In order to render the highly-sulphurated iron fit for affording hydrogen, it need only be heated with half its weight of filings.

not found native.

To apply pyrites to the same use, the same treatment may be adopted, or they may be distilled, in order to deprive them of that portion of sulphur which constitutes the difference between the sulphuret at the minimum, and that at the maximum.

The mineral kingdom has not yet presented iron sulphurated to the minimum. In the yellow coppery pyrites, which is a compound of two sulphurets, the iron is always at the maximum of its saturation, and accordingly these ores resist all acids, except such as can oxide the excess of sulphur.

Copper in both
states?

I shewed in my former memoir, that the native sulphuret of copper is usually found with an excess of sulphur amount-

ing to 14 or 15 per cent; it is very possible, that this metal may in its saturation follow the same law as iron, which requires to be examined; but only in the sulphurets which are pure; for in those which are complicated, or those in which the sulphuret of copper is an integrant part, I have found it without excess of sulphur.

The yellow copper ores, or the native union of the two sulphurets of copper and iron sulphurated to the maximum, afford by distillation less sulphur than the simple pyrites, because the sulphuret of copper in this mixture has no excess. The beautiful copper pyrites of Avarar in Biscay, affords no more than one twelfth of sulphur by distillation.

If these pyrites be fused with a portion of potash, the excess of sulphur unites to this alkali, and the sulphuret of iron is reduced to the minimum. The aqueous sulphuric acid may then be used to analyse them. It dissolves all the sulphuret of iron without affecting that of copper, which in that case presents itself with a deep blue colour, which is one of its characters. By this means we may obtain the proportion of the two sulphurets which compose this kind of mineral. But when we know the quantity of copper contained in a copper pyrites, we always know that of the sulphuret of the metal, because in nature, as well as in art, copper never takes up more or less than 28 grains of sulphur per quintal.

If we wish to ascertain the quantity of sulphuret in a copper pyrites, its nitric solution must be precipitated by sulphurated hydrogen, and the precipitate ignited in a retort. The product always represents the real quantity of sulphuret originally combined in the mineral.

Native Sulphuret of Manganese.

This sulphuret has not been noticed by mineralogists as far as I know. I discovered it some time ago in certain specimens of gold-ore from Nagyag.

The gangue of the piece which afforded this sulphuret is a carbonate of manganese mixed with quartz, like that of the sulphuret of Tellurium. It does not present metallic crystals of this metal, but a multitude of points, which under the magnifier appear to be an assemblage of pyritous parts. This mineral treated with the aqueous sulphuric acid, affords a

Copper pyrites, are mixed: their habitudes.

Analysis of the compound pyrites.

Copper in nature and also by art takes up exactly 28 per cent. of sulphur.

Native sulphuret of manganese.

History and description.

Treatment.

very abundant mixture of carbonic gas and sulphureous hydrogen. The first arises from the decomposition of the carbonate, and the second from that of the sulphuret.

This new sulphuret of manganese very easily known.

It is extremely easy to ascertain the existence of this new sulphuret. First, because among all those we are acquainted with there is none which is so easily decomposed, and with such abundance of this gas. Secondly, because the artificial sulphuret of manganese obeys the action of this acid with the same celerity. And thirdly, because we do not discover any thing else in the solution but oxide of manganese, and a very minute quantity of that of iron. The specimen does not contain either gold, tellurium, lead, or any other metal.

Ore of tellurium.

In the true ore of tellurium, I found that the sulphurets of lead and of tellurium are combined together, and that the gold is native, and not at all mineralized.

Is the manganese, metallic, or oxidized?

I shall add nothing further respecting the species of sulphuret here mentioned, because I have not enough to decide whether the manganese exists in the state of oxide or metal. If it be an oxide, its sulphuret may probably derive from a very condensed aggregation the power of eluding the activity of the atmospheric oxygen; for the artificial sulphuret passes with considerable speed to the state of black oxide mixed with sulphate.

Concerning the Dis-oxidation of Iron.

On disoxidation.

When we consider the facility, or low temperature which several oxides require to return to the metallic state, we cannot help thinking, that those which resist the effort of our furnaces, would also become disoxidized, if it were possible for us to heat them to the necessary degree.

Incident respecting the reduction of iron by iron heat.

In order that iron may no longer remain in the class of oxides which are incapable of reduction without the assistance of charcoal, I think it proper to record in this place an experiment, for which I am indebted to the friendship of Nast, manufacturer of porcelain, at that time established in the Fauxbourg St. Antoine.

A bar of iron oxidized nearly all through was reduced by heat in a porcelain furnace.

The mouth of his furnace for second firing, which is above the furnace itself, was supported by a bar of iron about an inch in diameter. The oxidation had approached so near its centre, that being no longer supported but by a thread of iron

of one line in diameter, it fell and broke to pieces. I collected the fragments, and separated the metallic thread by a slight blow. The oxide differed in no respect from the scales, which are separated from iron when forged.

I placed eight ounces of this oxide in a porcelain crucible inclosed in one of the faggers below. I was not ignorant that nothing more is necessary, than the fall of a single nail to destroy a whole pile. The following was the result: we found the crucible and the fagger perforated; the iron reduced and well fused had bedded itself in the floor of the furnace. We could not separate it but by blows of the chissel. It was not brittle. Did this iron melt merely by the intensity of the fire, or did it oxigenate some charcoal, or decompose the calcareous part of the pottery, &c. It would I think be an interesting object to ascertain this. I kept this iron for a long time, and do not at present know what is become of it. I was not sufficiently aware at the time how much the theory of chemistry might be interested in its examination. It is much to be desired that the experiment should be repeated.

Observations and queries.

Concerning Wax.

I think I may announce to you, that wax exists in the green fecula; I had before found it in that of opium, and expect to find it ready formed in the fecundating powder. I shall at some future opportunity treat it in the same manner as the fecula.

Wax in the green fecula of vegetables.

VII.

General Observations on the Causes which influence the Weather in England, and the popular Methods of judging of the Weather.
By JAMES CAPPER, Esq. formerly Colonel and Comptroller General of the Army and Fortification Accounts on the Coast of Coromandel*.

THOSE who are furnished with proper instruments, and who carefully observe the information they afford, will not often be mistaken in their judgment of the changes of the weather;

Philosophical instruments are of great utility for judging of the weather;

* From his "Observations on the Winds and Monsoons" 4to, London, 1801.

weather. The barometer, the thermometer, the hygrometer, and the electrometer, will generally give us timely notice of any material changes in the state of the atmosphere. But before we consider the best, or at least the usual modes of employing these instruments, we will beg leave to mention some common remarks of the peasantry, whose professions requiring them to live much in the open air, their opinions merit very great attention, being the result of local observation, continued from father to son, and verified from the experience of many ages. Amongst the first of these is one, now established into a proverb, that a rainbow in the morning is the shepherd's warning, but a rainbow at night is the shepherd's delight.

yet the common remarks of peasants are valuable.

Morning rainbow denotes rain; evening rainbow, fair weather.

Explanation of the prognostic.

With a west wind the morning rainbow to the west denotes coming showers; evening rainbow showers past.

Rain, if from the east, lasts 24 hours.

Explanation.

Weather usually clears at noon, but if not, then at sun-set.

Explanation.

In a country with the sea or ocean to the westward, and the wind from the same quarter, this opinion is likely to be true. If therefore, the clouds to the westward in the morning are saturated with moisture, which they must be to produce a rainbow, as these clouds proceed from the W. towards the E. they probably will produce rain; whereas, on the contrary, when the sun sets perfectly clear, and the clouds to the eastward are moist, it is a proof that the wet clouds are past, with a westerly wind, and the shepherd therefore may reasonably expect fine weather on the following day.

When it rains with an east wind, it probably will rain for twenty-four hours. This is another observation, which seems to me applicable to countries situated as above-mentioned, with land to the eastward; for, in general, the weather is dry in these countries with an east wind, but when the cohesion of the air and water is broken, the rain will not be violent, but of long duration.

The weather generally clears at noon, but when it rains at mid-day, it seldom clears up again till sun-set. The air, when dry and warm, continues to absorb and retain the moisture continually evaporated from the earth; as therefore the sun advances towards the meridian, and for an hour or two afterwards, he dries and warms the air; and consequently the rain is likely to cease at that time. But if there should be so much water in solution in the atmosphere, that the heat of the sun is not sufficient to produce these effects, in that case the rain will probably continue some hours longer.

Violent

Violent winds generally abate towards sun-set.

If we admit that wind is only a current of air put in motion by the rarefaction of the atmosphere in some particular place, and that this current of air is moving towards the point of rarefaction to restore the equilibrium, we must suppose, that as the sun declines the rarefaction will diminish, and consequently the velocity of the wind decrease. But this observation, in my opinion, rather applies to the temperate than to the torrid zone; for in whirlwinds and hurricanes the contrary may very often occur.

Strong winds abate at sun-set because the change of temperature changes the cause.

When the wind follows the course of the sun, it is generally attended with fair weather. This frequent and regular change of wind, which is never more than a moderate breeze, proves that there is no point of considerable rarefaction near, and therefore, the current of air follows immediately the sun's course: it always happens in summer, but very seldom when the sun's meridian altitude is less than 40 degrees.

Weather steady when the wind follows the sun.

The changes which take place in the atmosphere are principally marked by the rising and falling of the barometer, which apparently is caused by heat and cold, the hands with which nature performs her meteorological operations: by the former the atmosphere is rarefied, and consequently becomes light; by the latter it is condensed, and consequently becomes heavy. Hence probably the old remark, that a storm generally follows a calm; for during a calm the air is rarefied and expanded, and the cold air will rush forward in a strong current to restore the equilibrium, and necessarily produce what is generally called a gale of wind, the violence of which also will of course be in proportion to the degree of its preceding rarefaction.

A storm follows a calm;

because the air over any spot is more heated when quiescent, and the surrounding air rushes in.

For these reasons, the barometer falls suddenly whilst the air is expanded before a gale of wind, and rises again gradually as the condensed air returns, and the gale in like manner by degrees subsides.

The barometer confirms the fact.

It must however be observed, that an extraordinary fall of the mercury will sometimes take place in summer, previous to heavy showers of rain, particularly if attended with thunder and lightning; but in spring, autumn, and winter, the sudden extraordinary descent of the barometer indicates principally violent wind.

Summer showers denoted by a fall of the barometer.

Upon

Why the barometer varies little near the equator, and very much in high latitudes.
 St. Helena.
 Madras.
 S. of Europe.
 England.
 Petersburg.

Upon these principles likewise we may account for the rise and fall of the barometer in the different zones. In the torrid zone, particularly at St. Helena, and the islands of the Pacific ocean, it seldom varies more than three tenths; at Madras about five-tenths; in the south of Europe not more than one inch and two-tenths; in England it varies two inches and a half, and in Petersburg three inches four-tenths. In the two first, the temperature of the atmosphere is not subject to much variation, and never to any great degree of condensation. In the third, reckoning from the tropics to the latitude of 40° , the atmosphere may sometimes be suddenly condensed by currents of cold air from the N. and still more so in England. But the greatest variation must necessarily take place on the continent to the northward, where, during the summer, the weather is as hot as within the tropics; and, in winter, the thermometer for many weeks, continues several degrees below the freezing point.

Thermometer;
 hygrometer;
 electrometer.

The thermometer also, which measures the degree of heat in the air near the earth, will contribute towards denoting when changes are likely to take place in the lower regions of the atmosphere; the hygrometer distinguishes the quantity of moisture in the atmosphere, and the electrometer will point out the quantity of electricity which prevails in it.

The barometer little esteemed by farmers, because the words engraved thereon are fallacious.

The words generally engraven on the plates of the barometer rather serve to mislead than to inform; for the changes of the weather depend rather on the rising and falling of the mercury, than on its standing at any particular height. When the mercury is as high as fair, or at 30 degrees, and the surface of it is concave, beginning to descend, it very often rains; and on the contrary, when even the mercury is at 29 degrees, opposite to rain, when the surface of it is convex, beginning to rise, fair weather may be expected. These circumstances not being known, or not duly attended to, is the principal cause that farmers and others have not a proper confidence in this instrument.

Daily change in the barometer, and why.

It must also be observed, that *ceteris paribus*, the mercury is higher in cold than in warm weather, and commonly early in the morning, or late in the evening, than at noon, which seems occasioned by the obvious causes of the atmosphere being condensed by the cold of the night, and rarefied by the heat of the day.

The following observations of Mr. Patrick seem confirmed by experience. The old observations of Patrick are good.

1. The rising of the mercury presages, in general, fair weather, and its falling foul weather, as rain, snow, high winds, and storms.

2. In very hot weather the fall of the mercury indicates thunder.

3. In winter the rising presages frost; and in frosty weather, if the mercury falls three or four divisions, there will certainly follow a thaw; but in a continued frost, if the mercury rises, it will certainly snow.

4. When foul weather happens soon after the falling of the mercury, expect but little of it, and, on the contrary, expect but little fair weather, when it proves fair shortly after the mercury has risen.

5. In foul weather, when the mercury rises much and high, and so continues for two or three days before the foul weather is quite over, then expect a continuance of fair weather to follow.

6. In fair weather when the mercury falls much and low, and thus continues for two or three days before the rain comes, then expect a great deal of wet, and probably high winds.

7. The unsettled motion of the mercury denotes uncertain and changeable weather.

But to these remarks may be added, that, when the barometer suddenly falls two or three tenths, without any material alteration in the thermometer, and the hygrometer is not much turned towards moist, a violent gale of wind may be expected. When the hygrometer inclines far towards moist, with only a trifling descent in the barometer, it denotes a passing shower and little wind; and when the barometer falls considerably, and the hygrometer turns much towards moist, the thermometer remaining stationary, and rather inclined to rise than fall, both violent wind and rain are likely to follow in the course of a few hours. Prognostics of violent wind; of showers; or of a strong gale of wind and heavy rain.

General or common Prognostics of the Weather.

Amongst these we may reckon such as are derived from birds, beasts, insects, reptiles and plants, to which might be added great part of the wood work in houses, as doors, windows, window shutters, &c.

Common prognostics.

Birds

Birds dress their feathers against rain,

Birds in general retain in the quill part of their feathers a quantity of oil, which when they feel an extraordinary degree of moisture in the atmosphere, they express, by means of their bills, and distribute it over their feathers, to secure their bodies against the effects of an approaching shower.

and swallows fly low.

Swallows in pursuit of the flies and insects, on which they prey, keep near the earth in wet weather; and in dry weather, from the same cause, they fly much higher.

Cattle feed hastily, and go to shelter.

Domestic animals, as cows and sheep, but particularly the latter, on the approach of rain, feed with great avidity in the open field, and retire near the trees and hedges as soon as they are satisfied. In fine weather they graze and lounge about, eating and resting alternately with apparent indifference.

The pimpernel and dandelion much affected by the approach of wet weather.

The pimpernel, commonly called peep-a-day, or shepherd's weather-glass, closes its leaves before rain; and the down of the dandelion is much affected by moisture.

Wood work swells.

All wood, even the hardest and most solid, swells in moist weather. The vapours insinuate themselves into the pores of trees, and also into the wood-work of houses.

Insects alter their conduct in various ways.

Insects and reptiles of all kinds seek or avoid rain according to their respective habits, by these means giving notice of every change of weather.

The drains emit a smell;

It is a well known fact, that before rain, particularly in summer, a strong smell is perceived from drains and common sewers, as well as from every other body emitting a great quantity of effluvia. During fair weather, even in the summer, the atmosphere readily absorbs all the vapours and exhalations from the earth until it is completely saturated, and consequently the effluvia from the bodies which emit them, will then be confined and ascend in a narrow compass, like the smoke of a chimney in dry weather, almost perpendicularly; but when the air is saturated with moisture, and becomes rarefied and expanded, as it always does before rain, the volume of air containing the effluvia will be extended horizontally, and diverge from these different bodies as from a centre, and will be sensibly perceived on all sides, but will of course be most perceptible on that to which the current of air or wind moves.

because the air does not absorb the vapors.

On this subject see *Philos. Journal*, quarto, IV. 135.

Vapors seen in winter over water.

In winter, when the thermometer is between 34 and 40 degrees, the air being in a state of condensation, and the running

running water being warmer than the land, a mist or fog may be seen rising above the rivers, particularly when the air is cold and clear; but this vapour is no longer visible when the river is frozen, for though the ice be subject to evaporation, it does not yield so much vapour as water, and the water, in parting with its caloric in the moment of freezing, warms the surrounding air.

To the philosopher all objects in nature, both animate and inanimate, may afford both amusement and instruction, particularly in meteorology; but to observe them with due attention, we must quit the busy scenes of life; "and thus our lives exempt from public haunts, find tongues in trees, books in running brooks, sermons in stones, and good in every thing."

Amusement and instruction from the solitary contemplation of nature.

VIII.

Description of a Cheap, Simple, and Portable Instrument, for determining the Positions of Objects in taking a Picture from the Life. By R. L. EDGEWORTH, Esq.

THAT active and intelligent philosopher and journalist, Cit. Piçet, author of the *Bibliothèque Britannique*, on his late return from London to Paris, presented various instruments brought from this country to the National Institute of France. Among them was the instrument here to be described, and since published in the *Bulletin des Sciences*; on inspection of which my attention was excited to my notes, where, among other communications to be made to my readers, I find this instrument, as published in the excellent work "On Practical Education" by Maria Edgeworth and her father, to whom I have ascribed the contrivance in the title. The authors of the *Bulletin* affirm, that it was invented and executed by the children under the parental care of Miss Edgeworth; but I find no such intimation in the original work. The instrument of Professor Piçet is in various respects inferior to that which I have here copied; insomuch that Cit. Cloquet has proposed an amendment, for giving the index an horizontal position when it is required to transfer the observation to paper, which is in fact less effectual than the provisions made for that purpose,

Instrument for perspective presented to the National Institute;

was not as perfect as the original invention.

pose and for fixing the true instrument. After this preface, I shall proceed to copy without farther remark, page 460.

Advantages of early habits of delineation, and the inspection of drawings, &c. of machines.

“ An early use of a rule and pencil, and easy access to prints of machines, of architecture, and of implements of trades, are of obvious use in this part of education (mechanics). The machines published by the Society of Arts in London, the prints in Desaguliers, Emerson, le Spectacle de la Nature, Machines approuvées par l'Académie, Chambers's Dictionary, Berthoud sur l'Horlogerie, Dictionnaire des Arts et des Métiers, may, in succession, be put into the hands of children. The most simple should be first selected, and the pupils should be accustomed to attend minutely to one print before another is given to them. A proper person should carefully point out and explain to them the first prints that they examine; they may afterwards be left to themselves.

Method of conveying the requisite previous information,

“ To understand prints of machines, a previous knowledge of what is meant by an elevation, a profile, a section, a perspective view, and a (*vue d'oiseau*) bird's eye view, is necessary. To obtain distinct ideas of sections, a few models of common furniture, as chests of drawers, bellows, grates, &c. may be provided, and cut asunder in different directions. Children easily comprehend this part of drawing, and its uses, which may be pointed out in books of architecture; its application to the common business of life is so various and immediate, as to fix it for ever in the memory; besides, the habit of abstraction, which is acquired by drawing the sections of complicated architecture or machinery, is highly advantageous to the mind. The parts which we wish to express are concealed, and are suggested partly by the elevation or profile of the figure, and partly by the connection between the end proposed in the construction of the building, machine, &c. and the means which are adapted to effect it.

The art of perspective requires a contemplation of the mere picture of external objects.

“ A knowledge of perspective is to be acquired by an operation of the mind, directly opposite to what is necessary in delineating the sections of bodies; the mind must here be intent only upon the objects that are delineated upon the retina, exactly what we see; it must forget or suspend the knowledge it has acquired from experience, and must see with the eye of childhood no farther than the surface. Every person who is accustomed to draw in perspective, sees external nature, when he pleases, merely as a picture: this habit contributes much

to form a taste for the fine arts ; it may, however, be carried to excess. There are improvers who prefer the most dreary ruin to an elegant and convenient mansion, and who prefer a blasted stump to the glorious foliage of the oak.

“Perspective is not, however, recommended merely as a means of improving the taste, but as it is useful in facilitating the knowledge of mechanics. When once children are familiarly acquainted with perspective, and with the representations of machines by elevations, sections, &c. prints will supply them with an extensive variety of information ; and when they see real machines, their structure and use will be easily comprehended. The noise, the seeming confusion, and the size of several machines, make it difficult to comprehend, and combine their various parts, without much time, and repeated examination ; the reduced size of prints lays the whole at once before the eye, and tends to facilitate not only comprehension, but contrivance. Whoever can delineate progressively as he invents, saves much labour, much time, and the hazard of confusion. Various contrivances have been employed to facilitate drawing in perspective, as may be seen in “Cabinet de Servier, Memoirs of the French Academy, Philosophical Transactions, and lately in the Repertory of Arts.” The following is simple, cheap, and portable.

Young persons who understand perspective may acquire much mechanical knowledge from drawings.

“Plate XVI. Fig. 1. A, B, C, represent three mahogany boards, two, four, and six inches long, and of the same breadth respectively, so as to double in the manner represented. Fig. 2, the part A is screwed, or clamped to a table of a convenient height, and a sheet of paper, one edge of which is put under the piece A, will be held fast to the table. The index P is to be set (at pleasure) with its sharp point to any part of an object which the eye sees through E the eye-piece.

Description of the instrument for fixing the points in perspective views.

“The machine is now to be doubled as in Fig. 2, taking care that the index is not disturbed ; the point, which was before perpendicular, will then approach the paper horizontally, and the place to which it points on the paper must be marked with a pencil. The machine must be again unfolded, and another point of the object is to be ascertained in the same manner as before ; the space between these points may be then connected with a line ; fresh points should then be taken, marked with a pencil, and connected with a line ; and so on successively till the whole object is delineated.”

Its use.

The

Method of using
a plain graduated
ruler for taking
views, &c.

The above machine affords a delineation which is strictly accurate: but I take this opportunity of mentioning one still more portable, though less exact, which may be used in taking small sketches in the field; where the table, and fixed sheet of paper cannot always be supposed at hand. I do not know the contriver. It is merely a strait flat ruler, having a division of inches and small parts (or any other division) on its edge. A string is fastened to the middle of the ruler by passing it through a hole, and tying a knot on the other side; and at the other end of the string there is a small bead or knot to be held in the mouth. The length of the string may be adjusted at pleasure; and when the ruler is used, it is held up at right angles to the stretched string, so that its edge, as seen by one eye, may apply to any two objects; between which it will shew the distance to be afterwards transferred upon the paper by a scale, or by estimate.

Farther observa-
tions.

In this use of a graduated rule, it is most convenient and accurate to select some one object in the picture for the point of sight, and to measure all the distances from thence from the middle or beginning of the divisions where the direction of the sight is at right angles to the rule. And as this simple instrument does not give the inclinations, it may be best always to measure parallel or perpendicular to the horizon, and estimate the rest. Indeed, the contrivance must be considered only as a substitute for the usual method of estimating, and may be principally useful to assist in acquiring a correct judgment in this respect.

W. N.

IX.

Concerning the new Planet CERES. In a Letter from the Rev. WILLIAM PEARSON, including an Extract of a Letter from the BARON DE ZACH to Mr. EDWARD TROUGHTON.

TO MR. NICHOLSON.

S I R,

Parson's Green, March 9, 1802.

Introductory re-
marks. Popular
account of the
manner of apply-
ing observations.

AS the discovery of the new planet Ceres is an event which has already engaged the attention of the principal astronomers of Europe, and will continue to be a subject of discussion until

until the elements of its orbit shall be accurately assigned, it may be acceptable to many readers of your Journal to have a popular detailed account laid before them of the manner of applying observations to determine the whole period and form of the orbit, in order that they may comprehend, and consequently feel an interest in, the perusal of the different notices which will, most probably, be published from time to time in different countries.

When a heavenly body is first suspected to be a planet, the suspicion arises either from its apparent aspect compared to a star when viewed in a telescope, as was the case with Geo. Sidus, or otherwise on account of an observed change of relative situation, as was the case with the new planet Ceres when compared with some small stars in its neighbourhood: the first thing to be done after the supposed discovery of a new planet is, to ascertain its right ascension and declination, and from thence its geocentric longitude and latitude; the means used for doing which need not be described here.

How a planet is discovered—by its aspect through the telescope;—or its motion.

A series of observations, and corresponding calculations, are usually continued at successive intervals, until the newly discovered body has advanced or receded through such a portion of the ecliptic as to afford data for estimating its daily velocity when compared to that of the earth: now, if a series of observations could be made by an observer in the sun, the arc passed through by the planet would bear the same proportion to the interval of time elapsed between the first and last observations, that a circle does to the whole period, provided the motions were *equable*; and, if the motions were *unequable*, the observed progress at equal intervals would shew whether the inequalities were increments or decrements, and consequently whether the planet was approaching the perihelion or aphelion point. But the observed places are *geocentric*, and must therefore be converted into *heliocentric*, to gain those observations which an observer placed in the sun would make; for which purpose the proportion to be used will be, by a simple case in plane trigonometry, as the distance of the planet (to be at first assumed) from the sun: is to the sine of its observed elongation, or angular distance from the sun (or its supplement) :: so is the earth's distance from the sun, taken from the tables, : to the sine of an angle which is the difference between the heliocentric and geocentric places, and which is called the *parallax of the orb.*

Subsequent observations. These observations being made from the earth or geocentric, must be converted into heliocentric results, or such as would appear from the sun.

Manner of doing this.

From an heliocentric arc passed over in a known time, its *approximate period* is deduced;— and thence by Kepler's law a *correcter distance*. And the computations may thus be repeatedly amended.

The heliocentric arc, which the planet has passed through in a given time, being thus *nearly* ascertained, the whole *approximate period* is next found on a supposition of equal arcs being passed through in equal times; which will afford data for determining a somewhat more accurate distance of the planet from the sun, by the well known law of Kepler, by which the square of the periodic times are analogous to the cubes of the mean distances of the earth and any other planet respectively: an *approximate* distance being thus obtained may, in the next place, be substituted for the *assumed* distance, and the parallax of the orb be determined a second, and even a third time in this way; by means of which repetitions an *approximate* period, and a corresponding *approximate* distance, will be obtained. These will vary more considerably from the truth the greater the distance of the observed arc is from one of those two points of the orbit where the planet has a mean motion; which points are always nearer to the aphelion than to the perihelion point, by a quantity which depends upon the eccentricity. If therefore it should so happen that a new planet, at the time of its first discovery, were at, or very near, its mean distance, the whole period and distance obtained from a few of the first observations would be pretty accurate.

Errors from eccentricity,

corrected by determining the elementary points of the orbit, &c.

The next step to be taken is to determine the increments or decrements of motion, when a number of geocentric arcs are changed into heliocentric places, and thus to trace the points in the ecliptic where the velocity is a *maximum*, where it is a *minimum*, and where it is a *mean*. These will shew where the perihelion and aphelion points are, and also the place of equated anomaly at an instant when the equation is a *maximum*; these data afford the means of calculating the greatest equation and corresponding eccentricity; but before they can be assigned with accuracy, a considerable time must elapse to afford the astronomer an opportunity of observing a few successive oppositions or conjunctions and stationary points, for the purpose of correcting the approximate elements, and of determining the true shape and position of the orbit.

Determination of the obliquity and place of the nodes.

In the mean time the geocentric latitudes, gained by observation, must be also converted into heliocentric latitudes, in order to determine the nodes or points where the two opposite sides of the orbit cross the ecliptic. For doing this the analogy

is—As the sine of the planet's elongation from the sun: — is to the angle of commutation (or difference between the helio. longitudes of the planet and of the earth)—So is the tangent of the geocentric lat: is to the tangent of the heliocentric latitude.

From this account of the means necessary to be used in ascertaining the precise nature of the orbit of a newly discovered planet, it will be naturally inferred that the elements already assigned to the orbit of the new planet Ceres cannot be very accurate, allowing them to be duly proportioned to one another, because an error in any one of its elements renders all the rest erroneous; and there has not yet elapsed, probably, much more than one-fourth of an entire period since its discovery, nor has it yet been in the most essential portions of its orbit for affording the best data. Hence a continuation of accurate reports concerning this planet ought to be publicly recorded from time to time, in order that a comparison of different and distant observations may afford the requisite data for ultimately settling its elements with accuracy. I shall therefore make no apology for laying before your readers an extract from a letter of Baron Von Zach to his friend and correspondent, Mr. Edward Troughton, mathematical instrument-maker, of Fleet Street, who has very obligingly put it into my hands, with permission to make what use of it I may think proper. The letter is unusually long, and full of interesting matter; but I shall confine myself, in this communication at least, to those parts of it which principally relate to the new planet, and the subjects connected with it.

From the preceding account it follows that no elements of the new planet can yet be accurate.

Extract of a Letter from the Baron Von Zach to Mr. Edward Troughton. Letter from Von Zach.

Gotha, January 28, 1802.

“ ***** YOU have heard perhaps, dear friend, that I was so lucky as to discover again Mr. Piazzzi's planet, called now, in honour of the king of Naples, *Ceres Ferdinanda*. I found this little planet first on the 7th of December last year, just between the head and the north wing of Virgo, in $178^{\circ} 33\frac{1}{2}'$ right ascension, and $11^{\circ} 41\frac{1}{2}'$ declination N. An astronomical friend of mine, Dr. Olbers, in Bremen, found

Re-discovery of the planet Ceres.

found the planet on the 2nd of January between the N. σ 20 η and ζ Virginis. I have not heard that this little planet, which resembles a star of the ninth magnitude in size, has been seen in France and England. I have already given information of my discovery to the president of the Royal Society, Sir Joseph Banks. I have the honour to send you here my observations of this planet.

Table of observations.

SEEBERG OBSERVATORY.

		Mean Time.	Ap. Right Ascen.	Declination.
1801.	7 Dec.	18 ⁿ 48' 10,3''	178° 33' 30,6''	11° 41 $\frac{1}{2}$ ' N.
	31	17 38 $\frac{1}{2}$::	184 44 ::	11 5
1802.	11 Jan.	17 3 17,4	186 45 49,95	11 15
	16	16 46 25,6	187 27 53,25	11 26
	22	16 25 23,9	188 6 25,8	11 44
	25	16 14 32,9	188 20 39,15	11 54
	26	16 10 53,7	188 24 49,5	11 57

“ If you, or your astronomical friends, wish to look at the new planet Ceres, which is rather difficult, this heavenly body being so small, I send you here a little ephemeris, which will direct you in the research of this planet. With my eight feet transit instrument, by the late Mr. Ramsden, and with 200 magnifying power, I could not perceive the least mark of a disk. Perhaps Mr. Herschel will see more: perhaps he will discover some satellites to Ceres.

Ephemeris.

Position of the Ceres Ferdinandea for Midnight, in the Seeberg Observatory.

		Right Asc.	Declin.	Rt. Asc. in Time
1802.	Feb. 2	5 ^s 8° 43'	12° 31'	12 34 53
		5 6 8 45	12 47	12 35 1
		8 6 8 44	13 4	12 34 55
		11 6 8 38	13 22	12 34 33
		14 6 8 29	13 41	12 33 57
		17 6 8 16	14 1	12 33 5
		20 6 8 0	14 21	12 31 59
		23 6 7 40	14 42	12 30 40
		26 6 7 17	15 3	12 29 8
	March 1	6 6 50	15 24	12 27 22

Difficulties in the observations.

“ How much I want your four feet circle in my observatory, my present perplexity will show you. Hitherto I have observed all my zenith distances with a four feet Dollond's quadrant,

quadrant, and a circle of two feet from Cary; the telescopes have little aperture, so that I cannot see the new planet Ceres, and consequently I cannot observe the zenith distances: as the air all January was very hazy and cold, I had much ado to see the planet in my very excellent transit instrument. I must therefore wait till the planet shall increase in brightness, which yet will not go farther than to a star of the seventh magnitude. In the mean time I hope that by very clear weather I may distinguish the planet in my old quadrant, or in my little circle, and that this faint body will support the illuminating of wires, which has not been the case hitherto. This is the reason that I could not obtain one exact declination, but my right ascensions of Ceres are extremely exact. This difficulty will certainly never take place in my observatory when I once get your four feet circle. * * * * *

“As soon as the instruments arrive, I shall give you notice of it: in the mean while I have the honour to subscribe myself, with the greatest regard and highest esteem, which the reigning Duke of Saxe Gotha very sincerely shares with me,

Most honoured Friend,

Your most obedient Servant,

And devoted Friend,

FRANCIS BARON DE ZACH,
*Lieutenant-Colonel, and Director of
Seeberg Observatory.*

“Before I finished this letter, I had two observations more Latest observations. of the new planet Ceres, viz.

		Rt. Asc.	Ceres.	Decl.	Ceres.
28 Jan.	16 ^h 3' 29"	M. T.	188° 31' 37,85"	12° 9' 41,3"	
			tolerably well at the quadrant.		
29	15 59 43,7		188 34 18,13	12° 14'	only guessed."

This extract affords me an opportunity of illustrating the account, which has been just given, of the application of two distant observations of a planet for determining the heliocentric arc that has been run through in a given time: if I take the right ascension of Ceres for the 1st of Jan. 1801, as given by

Application of the instructions before detailed, to the observations on Ceres.

Piazzi's first observation, and also for the 26th of Jan. 1802, as given by the last observation of Von Zach in the present extract, and project the orbits of the earth and Ceres according to the eccentricity, mean distance and place of the aphelion of Gauss, as given in the extract from the *Moniteur* in the different journals, we shall have the figure represented in Plate XIII. Fig. 1, which is thus constructed, viz.

Construction of the orbits of the earth and Ceres, with the geocentric and heliocentric places of the latter, &c.

Supposing the point S to be the sun, describe, with any radius, the circle marked φ , γ , π , &c. for the ecliptic, and conceive it to be at an *infinite distance*; draw an occult line from S to $\odot 9\frac{1}{2}^\circ$, the earth's aphelion, and another to $\approx 26\frac{1}{2}^\circ$, the aphelion of Ceres; take 10 from a scale of equal parts, and describe with that radius the innermost circle $\Lambda \oplus P$ from a point $\frac{1}{5}$ of the radius from S towards A in the occult line, and another circle with a radius of 27,6 of those equal parts from the point C $\frac{1}{3}$ of the said radius from S in the second occult line, and these circles, which are eccentric with respect to the sun at S, will very nearly represent the required orbits of the earth and Ceres, in both which A represents the aphelion, and P the perihelion points. In the next place find the two points in the earth's orbit, which are diametrically opposite the sun's place for Jan. 1, 1801, at 9^h P. M. and Jan. 27, 1802, at 4^h A. M. which will be $\odot 11^\circ 1' 33''$ and $\Omega 6^\circ 35'$ respectively, and mark them as in the figure with their dates; after this mark the geocentric right ascensions of Ceres (denoted by the letter C with a cross beneath) for Jan. 1, 1801, and G at $\gamma 21^\circ 47' 48''$, according to Piazzi, and for Jan. 26, 1802, at G at $\approx 8^\circ 24'$, according to Von Zach, and draw the two dotted lines from S to each; then if dotted lines be drawn parallel to these two lines from the earth (\oplus) in Jan. 1801 and 1802 respectively, until they touch the orbit of the planet Ceres, these last lines will mark the geocentric *apparent places* of this planet in its *orbit*, of which the dotted lines from S to the ecliptic denote the *measure*; and, lastly, if lines be drawn from S through the geocentric places to the ecliptic to H and H, they will indicate the heliocentric longitudes, and the arcs contained between the heliocentric and geocentric measures will be on each day the measure of what is called the parallax of the orb.—This method of converting geocentric into heliocentric places by projection is capable of great accuracy, and is, so far as I know, original.

The method of converting geocentric portion into heliocentric

The

The reason of drawing the occult *parallel* lines, which may by projection is not occur to the reader, is this; as the ecliptic is considered considerably accurate;—and to be an infinite distance, so that the whole orbit of the earth, new. if seen from it, would appear only as a point, a line drawn to it from the sun, and another parallel thereto from the circumference of the earth's orbit, will, to an eye placed in the ecliptic, even if it were only at the distance of a star, appear *coincident* on the *same line*; hence if a line be drawn from the earth to the planet in its orbit, let their respective situations be what they may, another line drawn parallel to that from the sun, till it reaches the ecliptic, will shew the geocentric measure therein the same as if that measure were taken in a graduated ecliptic described from the earth as a center, and having all its divisions exactly parallel to those of the ecliptic described from the sun as a center.

Indeed, I have tried this projection with the geocentric and heliocentric places of some of the other planets taken from an ephemeris, and find it extremely accurate as well as easy. Tried with the other other planets.

From this projection of the heliocentric and geocentric places of Ceres, it appears evident that the distance from the earth to it was much greater last summer when the earth was at P, than it is at present, and it is equally evident, that as the velocity of the earth is greater than that of the new planet, and as they were both moving in the same direction at the latter period in the projection, the distance will continue to diminish until both the planets are in the same strait line as seen from the sun, agreeably to what is said in the extract from Von Zach's letter; for the apparent magnitude is in an inverse ratio of the distance, so that as the distance diminishes, the apparent disk increases. The reason also appears clear, why there was very little apparent motion of the new planet in the last month as seen from the earth, for in this part of the earth's orbit Ceres would *appear* to have a retrograde motion, provided it were at *rest*, but its forward motion in a certain degree balanced that, and produced the effect of little or no apparent motion at all:—on the 6th or 7th of Feb. last it was stationary, and has been since retrograde in a small degree. Remarks from the projection on the relative motions and apparent magnitude of the planet.

Determination of the heliocentric arc passed through,

In order to ascertain by calculation the heliocentric arc passed through in 390,3 days, the time contained between Jan. 1, 1801, at 9 P. M. and Jan. 27, 1802, at 4 A. M. the heliocentric longitudes of the new planet may be ascertained thus;

	S	°	'	"
1801, Jan. 1 ^d 9 ^h sun's long.	9	11	1	33
Right ascension of Ceres	1	21	47	48
	<hr/>			
Elongation	7	19	13	45
	<hr/>			

Then at 27 (supposed distance)	1,43136
Is to sine of 49° 14'	9,87931
So is 10 (earth's distance)	1,00000
	<hr/>
	10,87931
	<hr/>
	1,43136
	<hr/>

To sine of paral. of orb. 16° 17' 9,44795

	S	°	'	"
Again 1802, Jan. 26 ^d 16 ^h sun's long.	10	6	35	
Right ascension of Ceres	6	8	24	
	<hr/>			
Elongation	3	28	11	
	<hr/>			

Then as 27	1,43136
Sine of 61° 49' (supplement)	9,94519
So is 10	1,00000
	<hr/>
	10,94519
	<hr/>
	1,43136
	<hr/>

To sine of paral. of orb. 19° 3' 9,51383

Geocentric place of Ceres:	S	°	'	"	Parallax	°	'
Jan. 1, 1801	1	21	47	48	16	17	
Jan. 26, 1802	6	8	24	49	Ditto	19	3
	<hr/>					<hr/>	
Whole geocentric arc	4	16	37	1		35	20
Deduct sum of parallaxes	1	5	20			<hr/>	

Whole heliocentric arc 3 11 17 1 in 390,3 days.

Now, if the motion of the planet were equable throughout its orbit, we should have the whole tropical period from this ratio, as 101° 17' 1" : 390,3^d :: 360° : 1387,27 days, but the portion

and thence of the period 1387,27 days,

portion of a circle, which has been past since Jan. 1, 1801, is that in which the velocity has been above a mean velocity; therefore the period thus obtained is shorter than the true period by a quantity which depends upon the equation of the center, which has not yet been examined. At present want of leisure, and the length of this paper, render it necessary that I should defer entering upon the other particulars, which remain to be discussed, some of which, it is presumed, will be found interesting; for I propose to show that some of the elements assigned by Gauss, which are considered as the most accurate, are not in due proportion to one another. This discussion will therefore constitute the subject of another communication. In the mean time we may infer, either that the whole period is shorter than has been prematurely determined, or otherwise that the greatest equation should be much greater than the eccentricity at present assigned requires. Indeed, it will hereafter appear that the eccentricity, given from the *Moniteur* in the different journals, is almost *two-thirds* too little to correspond to the equation which has been attributed to the new planet.

which, for reasons given, is too short,

though the period generally given must either be too long; or the greatest equation must exceed what the assigned eccentricity requires.

I am, SIR, as usual,

Your's very respectfully,

W. PEARSON.

The early observations of Professor Piazzi, to which Mr. Pearson refers, are given by the professor in the following tables. The computations in the latter table were made from elements which, at the present time, would require to be greatly amended; but I have not chosen to omit them. W. N.

Early observations of Piazzi.

Table of the Mean Time, Right Ascension, and Declination of the new Star as observed; together with the Longitude of the Sun, and the Logarithm of its Distance from the Earth.

Right ascensions and declinations of Ceres Jan. and Feb. 1801.	Days of the Month.	Ten Thousandths of the day in mean Time.	Right Ascension.	Declination.	Sun's Place.	Log. Distance of from \oplus
January.	1	3635	51 ⁹ 47' 48.7''	15 ⁹ 37' 43.5''N	9 ^s 11 ^o 1' 33.1''	9,992617
	2	3606	43 27.7:	41 5.5	12 2 31.7	9,992629
	3	3577	39 36::	44 31.6	13 3 30.2	9,992641
	4	3547	35 47.2	47 57.6	14 4 29.0	9,992652
	10	3378	23 1.5:	16 10 32.0	20 10 29.5	9,992768
	11	3350	22 26.0	14 30, est.	21 11 29.5	9,992794
	13	3295	22 34.5	22 49.5	23 14 28.0	9,992848
	14	3268	22 55.8	27 5.7	24 14 27.3	9,992882
	17	—	27 35::	40 13.0	—	—
	18	—	28 45::	—	—	—
	19	3136	32 2.2	49 16.1	29 19 14.1	9,993060
	21	3084	38 34.0	58 35.9	10 1 21 2.5	9,993151
	22	3059	42 21.3	17 3 18.5	2 21 55.1	9,993196
	23	3033	46 43.5	8 5.5	3 22 46.4	9,993242
	24	—	51 45::	—	—	—
	28	2909	52 13 38.3	32 54.1	8 26 45.5	9,993522
	30	2860	27 2.1	43 11.0	10 28 10.6	9,993645
	31	2837	34 18.8	48 21.5	11 28 55.5	9,993708
	February.	1	2813	41 48.0:	53 36.5	12 29 36.6
2		2789	49 45.9	58 57.5	13 30 17.0	9,993851
4		—	53 7 45::	—	—	—
5		2719	15 40.5	18 15 1.0	16 32 13.9	9,994083
8		2650	44 37.5	31 23.2	19 35 2.2	9,994328
11		2583	54 16 23.1	47 58.8 N	22 35 41.3	9,994588

N. B. The observations marked with two points (:) are a little doubtful; those marked with (::) very uncertain.

Table of the Geocentric Longitudes and Latitudes of the new Star, both by Observation and Calculation; together with their Differences.

Longitudes and latitudes of Ceres, Jan. Feb. 1801.

Days of the Month.	Geocentric Longitude.		Differ.	Geocentric Latitude.		Differ.
	Observat.	Calculat.		Observat.	Calculat.	
1	1° 23' 22" 58.5 ¹¹	1° 23' 21" 59.2 ²	-59.3 ¹	3° 6' 32.4 ¹¹	3° 6' 50.2 ¹¹	+17.8 ¹¹
2	19 44.8	18 40.2	-64.6	2 13.1	2 27.7	+16.6
3	16 49.3	15 47.1	-62.2	2 57 58.9	2 58 63.3	+7.4
4	14 16.5	13 18.9	-57.6	53 44.5	53 48.4	+3.9
10	7 59.4	7 19.5	-39.9	28 50.9	28 31.8	-19.1
11	8 25.7	7 43.4	-42.3			
13	9 58.0	9 38.9	-19.1	16 49.0	16 21.0	-28.0
14	12 1.6	11 32.9	-29.0	12 47.1	12 23.2	-23.9
19	25 49.4	25 51.5	+2.1	1 53 28.3	53 1.3	-27.0
21	34 21.8	34 23.4	+1.6	45 58.9	45 31.6	-27.3
22	39 1.8	39 6.7	+4.9	42 18.7	41 51.3	-27.4
23	44 15.6	44 17.4	+1.8	38 39.2	38 12.3	-26.9
28	24 15 16.0	24 15 28.1	+12.1	20 58.7	20 32.0	-26.7
30	30 5.4	30 23.0	+17.6	14 5.3	13 43.5	-21.8
31	38 8.6	38 20.5	+11.9	10 45.0	10 22.4	-22.6
<hr/>						
	46 19.6	46 38.0	+18.4	7 23.8	7 3.6	-20.2
1	54 55.6	55 12.8	+17.2	4 0.7	3 47.0	-13.7
5	25 22 43.5	25 22 52.8	+9.3	0 54 19.0	0 54 9.6	-9.3
8	53 17.9	53 15.6	-2.3	44 42.7	44 50.9	+8.2
11	26 26 26.1	26 26 24.8	-1.3	35 47.9	35 50.4	+2.5

January.

February.

X.

Entertaining chemical Experiments; with Notices of various new Facts and Observations respecting the Products of Nature and Art. By Mr. FREDERICK ACCUM. Communicated by the Author.

1. Production of phosphorated Hydrogen Gas*.

AS the usual method of obtaining phosphorated hydrogen gas, and exhibiting its spontaneous inflammation, requires a considerable share of attention and manual dexterity, the amateur of chemistry will deem it not superfluous to have no-

Easy method of producing phosphorated hydrogen.

* This and the five following Experiments were first noticed by Mr. Davy, who exhibited them in his lectures at the Royal Institution.

ticed here the method of producing this gas in a more easy, expeditious, and economical manner, by merely presenting phosphorus to nascent hydrogen.

Zinc, sulphuric acid, and phosphorus, afford the gas;

which takes fire spontaneously, and continues to burn in a beautiful manner.

For this purpose, let water be decomposed in the usual manner, by means of zinc and sulphuric acid, and add to the mixture a quantity of phosphorus. The hydrogen evolved will dissolve part of the phosphorus; phosphorated hydrogen gas will be produced, and take fire at the surface of the fluid, so long as the decomposition of the water is made with considerable rapidity. But the gas produced in this process burns with a more lambent flame than that obtained in the usual manner, probably on account of containing a larger quantity of hydrogen. The experiment is nevertheless brilliant; for the gas is disengaged in small bubbles, which cover the whole surface of the fluid; they disengage themselves rapidly, new ones are produced, and the whole fluid resembles a well of fire.

Particular instructions.

For the success of this experiment, it is essential that the water, during the action of its decomposition, be considerably heated, which may be effected by a copious addition of sulphuric acid, and that the phosphorus be present in a considerable quantity. Half a part of phosphorus cut into small pieces, one of granulated zinc, three of concentrated sulphuric acid, and five of water, answer this purpose exceedingly well.

2. *Phosphorated Hydrogen Gas burns with a green Light in nascent hyperoxigenised Muriatic Acid Gas, under the Surface of Water.*

Phosphuret of lime, hyperoxigenised muriate of potash, phosphorus, and sulphuric acid, produce fire under water.

Put into an ale-glass, or Florence flask, one part of phosphuret of lime, broken into pieces of the size of a pea [not in small fragments or in powder], and add to it half a part of hyperoxigenised muriate of potash. Fill the vessel with water, and bring carefully into contact with the materials at the bottom of the fluid, three or four parts of concentrated sulphuric acid. This may most conveniently be done, by letting the acid fall through a long-necked funnel, reaching to the bottom of the vessel, or by causing it to pass down the sides of it. As soon as the decomposition of the water, and that of the hyperoxigenised muriate, takes place, flashes of fire dart from the surface of the fluid, and the phosphuret illuminates the bottom of the vessel with a beautiful green light.

3. *Combustion*

3. *Combustion of phosphorated Hydrogen Gas, by the Admixture of hyperoxygenised Muriatic Acid Gas.*

If phosphorated hydrogen and hyperoxygenised muriatic acid gas be mixed together, fire and flame are produced; and simple muriatic acid, water, and phosphoric acid, are formed. Flame by mixture of two gases.

4. *Combustion of inflammable Substances in nascent hyperoxygenised Muriatic Acid Gas.*

Put into a wine-glass one part of hyperoxygenised muriate of potash perfectly dry; pour on it, two of colourless sulphuric acid of commerce: a violent action will take place, and hyperoxygenised muriatic gas becomes evolved. If, during the extrication of this gas, one part of sulphuric ether, alcohol, or oil of turpentine, be suffered to fall into the gas, an accension takes place, accompanied with a crackling noise. Numerous combustions in hyperoxygenised muriatic gas:

In this manner not only all the inflammable fluid bodies, but likewise most of the solids, such as camphor, resin, tallow, pitch, elastic gum, &c. may easily be inflamed.

5. *Combustion of expressed Oils at the Surface of Water, by Means of hyperoxygenised Muriatic Acid Gas.*

Put into an ale-glass one part of hyperoxygenised muriate of potash; add to it three or four of water, and half a part of oil of olives, or of linseed. On adding to it four or five parts of concentrated sulphuric acid, a violent action takes place, much charcoal becomes deposited, and a multitude of ignited sparks pass through the black fluid, exhibiting a beautiful phenomenon. On adding an additional quantity of hyperoxygenised muriate of potash and sulphuric acid, the whole mass takes fire, and burns with a dense yellow flame. of oils on water;

6. *Combustion of Phosphorus in hyperoxygenised Muriatic Acid Gas, under the Surface of Water.*

Let fall into a wine-glass, or rather into a long cylinder, filled two thirds with water, one part of phosphorus, and two of hyperoxygenised muriate of potash. On adding to this mixture three or four parts of sulphuric or nitric acid, the phosphorus takes fire, and burns vividly under the surface of the fluid: on agitating the mixture, streams of ignited sparks pass through the fluid rapidly. phosphorus under water.

Remark.

Remark.—This and the two preceding experiments require caution. The operator ought to be distant during the affusion of the acids, or the addition of the combustible body, which are sometimes thrown out of the vessel to a considerable distance.

7. *Decomposition of sulphureous Acid Gas, by Muriate of Tin.*

Decomposition
of sulphuric gas
by mur. of tin.

If sulphureous acid gas, and fresh prepared muriate of tin, be brought into contact, the volume of the gas becomes speedily diminished, sulphur is deposited, and the simple muriate becomes converted into an oxygenated muriate of tin.

8. *Syrup of Violets, which has lost its Colour, regains it, when agitated in Contact with Oxygen Gas.*

Syrup of violets
restored by oxygen.

It is a fact well known to chemists, that syrup of violets is apt to lose its colour by age, though not the least perceptible change in the saccharine solution has taken place, when exposed to light, or even when frequently agitated in contact with atmospheric air. In order to make the discoloured syrup regain its primitive blue colour, nothing more is necessary than to agitate it for a few minutes in contact with oxygen gas.

9. *Phosphorated Hydrogen Gas is decomposed by Light.*

Light decomposes
phosphorated
hydrogen.

Though phosphorated hydrogen gas may be kept over mercury in the dark for any length of time unaltered, this is not the case if the gas be exposed to light. In this situation the union of the phosphorus and hydrogen is broken, the phosphorus becomes separated, and crystallizes in the vessel, and the hydrogen is left behind.

10. *Acetite of Barites is capable of crystallizing.*

Crystals of acetite
of barites.

A solution of acetite of barites, prepared by dissolving pure barites in pure acetous acid, which had been exposed to light in an open glass vessel, was found to be converted into a solid regular crystalline mass. The form of the crystals could not be determined, on account of their extreme minuteness.

11. *Spontaneous Reduction of Howard's fulminating Mercury.*

Spontaneous
reduction of
fulminating
mercury.

Four ounces of Howard's fulminating mercury were placed still wet on a chalk stone, exposed to the rays of the sun in a window. It was left in this situation unobserved for at least three

three

three months. The product during this time was converted into a black brilliant powder. On attempting to collect it together into one heap, and separating it from the paper which had been interposed, a globule of running mercury was seen. On introducing the powder into a bottle, and shaking it together, heat was evolved, and the whole mass became reduced to the metallic state.

12. *Production of red Sulphuret of Mercury in the humid Way.*

When equal quantities of a concentrated solution of oxygenated muriate of mercury, and concentrated fresh prepared fuming hydrosulphuret of ammonia, are mingled together, a brownish muddy precipitate is produced, which, when left undisturbed, turns yellow in three or four days, then orange, and at last acquires a beautiful cinnabar-red colour. The sulphuret of mercury, when separated, possesses all the properties of the best vermilion which is met with in commerce.

Cinnabar in the humid way.

13. *Air Bladder of the Carp contains common Air.*

The air bladder of the carp does not contain nitrogen, as Fourcroy, &c. assert. If the air of the bladder of this living fish be examined, it will be found to contain atmospheric air, and not nitrogen.

Error of Fourcroy concerning azote.

14. *Fish Bones contain much phosphoric Acid.*

The bones of fish contain upwards of one sixth part more of phosphoric acid, than those of quadrupeds. They may therefore advantageously be employed for making phosphorus.

Fish bones abound with phosphorus.

15. *Wax from Spiders.*

The yellow matter deposited in vessels containing spiders preserved in alcohol, is a true wax, which may be obtained from these animals by gently heating them.

Spiders' wax.

16. *Fluoric Acid dissolves Lead.—Method of obtaining it pure.*

Fluoric acid obtained in the usual manner, by decomposing fluuate of lime by sulphuric acid in a leaden retort, always contains lead in solution; as may be proved by mingling the acid with a solution of water impregnated with sulphurated hydrogen gas. Tin vessels are less acted upon than those made of lead. The acid has no effect upon silver.

Common fluoric acid contains lead.

How to obtain it
pure.

In order to obtain pure fluoric acid, one part of fluor spar reduced to a fine powder, may be mixed with two of sulphuric acid, and one of water. The mixture is then to be introduced into a glass retort, to which a glass receiver has been previously luted, containing two ounces of water. Heat being then applied, the distillation is to be carried on slowly. After the decomposition of the fluoate of lime is effected, which may be known by the disappearance of the whitish vapours in the retort, the contents of the receiver must be filtered, and distilled water added to the filtered fluid, till, on a new admixture of water, no further cloudiness appears. The acid thus obtained contains no silex; it is absolutely pure; and may be kept in glass bottles covered within with wax, or, in preference, with a hard varnish.

17. *Benzoic Acid exists in Vanelloe.*

Crystalline matter
on vanelloe.

A quantity of vanelloe pods [*Epidendrum Vanilla*, L.] which had been kept wrapt up into a bladder, and surrounded with thin sheet lead for upwards of four years, were found to be covered with a white powder of a pungent saline taste. On examining the internal parts of the wrinkled shell of the pods, the black seeds, when viewed under the magnifier, were found to be covered over with a multitude of oblong crystals, crossing each other in all directions.

Experiments
proving it to be
benzoic acid.

In order to examine these crystals, one ounce of the pods were broken into small pieces, and boiled in a Florence flask, with a quarter of an ounce of lime and six ounces of distilled water, for about ten minutes. The whole mass was then suffered to repose, and the clear fluid, which was of an amber colour, and aromatic bitter taste, was set aside. The residue was treated in a similar manner, and the fluid was added to the first. The clear solutions were then slowly evaporated to one fourth. During this process a quantity of a brown adhesive substance separated, which had all the properties of a true resin; its weight amounted to nine grains. On letting fall into the concentrated solution, from which this resin had been separated, some pure muriatic acid, the whole became turbid, and a pulverulent yellow precipitate was deposited, which increased in quantity on heating the mixture. All the precipitate obtained in this manner was then dissolved in distilled water, filtered, evaporated, and crystallized; it yielded beautiful

tiful lemon-yellow crystals, which could not be obtained colourless, by repeated solutions and re-crystallizations. But after boiling them with charcoal powder, the fluid passed colourless through the filter, and yielded pure benzoic acid in the form of silky needles, weighing 23 grains.

18. *Camphor does not move upon Water at low Temperatures—
Phosphorus moves upon Mercury.*

If a basin of water, upon which small fragments of camphor are in rapid motion, be suddenly transferred into a freezing mixture, the rotatory motion of the atoms of camphor instantly ceases. Camphor motionless on water in a very cold atmosphere.

If a cylinder of dry phosphorus be scraped with a knife over a saucer containing mercury free from dust, &c. the small particles of phosphorus which are detached, and fall upon the quicksilver, spin in a similar manner like those of camphor placed upon clean water. Phosphorus moves on mercury;

Camphor, benzoic acid, musk, castor, civet, assafoetida, vanilloe, and various other odoriferous substances, remain motionless when placed upon this fluid. but camphor, &c. do not.

19. *Frogs change their Colour, and decrease in Size, when secluded from Light, and die when suddenly exposed to vivid Light.*

A number of male frogs of the largest size, and of a beautiful yellowish brown colour, which had been kept for upwards of six months in a reservoir, situated in a dark place, lost their colour during that time, became perfectly black, and had decreased in size to less than one half. A number of these animals, which were very brisk, and apparently in a good state of health, were exposed to the rays of the sun, in order to see if they would regain their colour. They all died, during the experiment, in about three hours. The galvanic influence could not stimulate their dead muscles into action. Frogs become black and smaller by keeping in the dark. Light kills them and destroys all irritability.

A frog, which had escaped, was found in a vessel containing a concentrated solution of potash, freed from carbonic acid, in which, from the time of discovery, he could not have remained longer than three hours. The animal was much distorted, and converted into a flesh-coloured gelatinous mass. It was beautifully transparent, and twice its natural size. On pouring boiling water upon it, the whole was dissolved into a jelly. A frog converted by potash into a soluble clear mass.

Frogs

Habitudes of these animals in different fluids and gases.

Frogs kept in distilled water soon become languid, and die. They cannot live in water impregnated with nitrous oxide, nor in water holding carbonic acid gas in solution in considerable quantity. They live in an atmosphere of pure nitrogen for five or six days, if water be present. They instantly die in all hydrocarbonates; but may be kept alive in nitrous gas for some days.

XI.

The Method of crystallizing Lime. By TROMMSDORFF.*

History of the crystallization of lime.

THE crystallization of lime was first discovered accidentally by Schaub. Bucholz also obtained very fine crystals of this earth by boiling it with its muriate. I have verified this discovery; and find that lime may be obtained in crystals equally well in winter as in summer; with the exception, that the salt prepared during the winter season forms crystals which are thicker and larger. In order to obtain these crystals, any quantity, at pleasure, of the muriate of lime is to be boiled with one fourth, or even less, of caustic lime, and the fluid concentrated until in winter a drop of the solution, let fall upon a cold stone, shall acquire the consistence of syrup without crystallizing or congealing. The fluid is then to be strained through a close cloth filter into a capsule of porcelain or earth, which is then to be covered with a similar capsule, or a wooden cover, in order that the cooling may be as slow as possible. By this means very long but slender crystals of caustic lime are obtained, which must be washed in alcohol to clear off the adherent muriate. This operation must not be attempted with a less quantity than seven pounds of muriate of lime.

How effected.

Residue, after distilling ammonia from much lime, is the crystallized earth.

It is well known, that when muriate of ammonia is distilled with excess of lime, for its decomposition, part of the residue adheres so strongly to the retort, that it is almost impossible to detach it by softening it. This hard mass is for the most part formed of lime confusedly crystallized, which is more difficultly diffused in water than the same earth in powder, or a state of minute division.

* Journal der Pharmacie, vol. ix. part 1. p. 108.

XII.

On the Crystallization of the Hidrosulphuret of Soda. By C. IT. VAUQUELIN*.

BERTHOLLET, in a memoir which he communicated to the Institute about four years ago, shewed that sulphurated hydrogen has several properties in common with the acids, such as that of reddening the tincture of turnsole, uniting with the earths, the alkalis, and the metallic oxides, and forming crystallizable combinations with some of these substances.

I have had occasion to observe, a few days ago, one of the combinations of this kind, namely, that of sulphurated hydrogen with soda. Having lixiviated a considerable quantity of soda, manufactured by Citizens Payen and Bourlier, to extract the carbonate of soda, I left the concentrated mother water in a corner of the laboratory. At the end of some decads, I found at the bottom of this liquor a white transparent salt, crystallized in rectangular tetrahedral prisms, terminated by four-sided pyramids, some of which were octahedral. As this is not the form assumed by carbonate of soda, I made some experiments to determine its nature. Its taste was at first acrid and caustic, nearly resembling that of the alkalis, which led me to suspect that it might be caustic soda; but I was soon undeceived, by an insupportably bitter taste which succeeded, and by a slight odour of sulphurated hydrogen gas.

It is abundantly soluble in water; and notwithstanding the causticity, which seems to announce that the alkali is united with a slight acid, nevertheless it absorbed caloric in its solution. Its solution had no colour, but the smell of sulphur was stronger than that of the salt itself; the acids produced a lively effervescence, and developed a very strong smell of sulphurated hydrogen gas. But the fluid did not become turbid: the nitric and oxigenated muriatic acids, on the contrary, formed an abundant precipitate, which, when washed and dried, exhibited all the characters of slightly hydrogenated sulphur. The salt, or its solution, spread on blotting paper, soon assumed a dark green colour. Lastly, this salt precipitates all the metallic oxides from their solutions, perfectly

Berthollet's observations, that sulphurated hydrogen performs the functions of an acid.

Sulphurated hydrogen forms with soda a crystallizable salt;

of an acrid, caustic taste;

succeeded by extreme bitterness;

very soluble in water, and producing heat;

effervescing with acids;

depositing sulphur by the nitric and ox. mur. acids;

dark green as it dries; precipitates metals like an hydrosulphuret;

* Annales de Chimie, No. 122, vol. xli. p. 190.

but does not
throw down the
earths;
whence the al-
kali is saturated.

With sulphate of
iron it affords
hidrosulphuret
of iron, and sul-
phate of soda.

The manufactu-
rers did not use
chalk enough,
&c.

milar to those which the same substances assume when precipitated by the artificial hidrosulphuret of soda. It does not precipitate the earths when dissolved in the acids, excepting alumine, zircon, and yttria; which proves that the alkali is perfectly saturated with sulphurated hydrogen gas.

This salt, when decomposed by sulphate of iron, afforded hidrosulphuret of iron, and sulphate of soda, which were obtained crystallized by evaporation and cooling of the liquor; whence this salt is a true hidrosulphuret of soda.

The presence of this salt in the soda of Messrs. Payen and Bourlier, proves that these manufacturers did not use a sufficiently large quantity of chalk to saturate the whole of the sulphur arising from the decomposition of the sulphate of soda by charcoal; unless we suppose that it is formed during the decoction the alkali is made to undergo when extracted from the carbonate of soda.

Remark.

The whole novelty of this observation consists in the property which this salt has of crystallizing, and the determination of its figure. Its other properties have been described by Citizen Berthollet with great exactness.

XIII.

*Memoir respecting a new Combination discovered in Zaffre, which
CIT. BRUGNATELLI supposed to be a peculiar Acid, which
he denominated the Cobaltic Acid. By CIT. DARRACQ*.*

Supposed disco-
very of a new
acid in cobalt,
by Brugnatelli.

CITIZEN Brugnatelli, in a memoir printed in the *Annales de Chimie* for the month of Pluiose in the year 8, page 113 †, relates various experiments upon zaffre, or the grey oxide of cobalt, from which he concluded that this substance contains a new acid. I shall describe some of these experiments, as well as certain properties attributed to his cobaltic acid.

He digested zaf-
fre in ammonia;
filtered and eva-
porated to dry-
ness. The resi-
due gave oxide
and the supposed
new acid, united
with ammonia.

He took zaffre, which he left in digestion with ammonia. After some days maceration in the sun he obtained a fluid of a red colour, known by the name of ammoniuret of cobalt, which he filtered and evaporated to dryness. The concrete residue thus obtained appeared to him to consist of two very distinct substances, one of a deep red colour, and the other of

* *Annales de Chimie*, No. 121. Vol. XLI. p. 66.

† *Philos. Journal*, quarto, IV. 36.

a pale yellowish tinge. The red part was soluble in water, and the yellowish remained upon the filter. This residue he considered as the pure oxide of cobalt. The soluble part was evaporated, and by cooling it deposited certain small crystals, which Citizen Brugnatelli inferred to be a combination of the new cobaltic acid with ammonia. The supernatant liquor also possessed evident characters of acidity.

The author observed, that his acid might be obtained either coloured or colourless, according to the methods used in procuring it. Evaporations made by fire left a residue soluble in water, and afforded a cobaltic acid nearly colourless, whereas those made in the light of the sun always afforded it more or less red. Citizen Brugnatelli being desirous of ascertaining whether his acid was formed during the operation here described, or whether it existed ready formed in zaffre, boiled for twenty-four hours six pounds of this substance in eight pounds of water. He filtered the liquid while hot and evaporated it. When it was reduced to half it became turbid; the evaporation was continued until no more than one third of the fluid remained. It was then taken from the fire and deposited a white substance, which was collected upon the filter. The fluid which passed was of a bright yellow colour, with a sensibly acid taste; it acted in all respects the same as the cobaltic acid obtained by the process before pointed out.

It is either coloured or colourless.

Zaffre boiled with water afforded it.

The following are among the properties which Citizen Brugnatelli considers as characteristic.

Properties stated as characteristic of this acid.

1. It precipitates the solution of silver.
2. It precipitates lime water in a white coagulum insoluble in water, and in an excess of acid.
3. It is separated from its aqueous solution by alcohol.
4. It precipitates the acetite and muriate of barites.

I shall now proceed to describe the experiments I have made on this subject, and present to the Institute the consequences which I deduce from the same.

New experiments.

Experiment 1. I formed the ammoniuret of cobalt by leaving zaffre in digestion in the sun's light in ammonia. I was careful to agitate the mixture which was included in a matras, and soon obtained a red colour, that after forty-eight hours became a bright red. I observed in this fluid a crystallization in considerable abundance, in the form of white brilliant needles. This crystallization was permanent till the sun

Experiment I. The ammoniuret was formed.

had again heated the fluid, when it became dissolved in the liquid. In this state the ammoniuret of cobalt was filtered, and put into a retort; in proportion as its temperature increased it assumed a violet red colour which grew deeper and deeper, and at length had the appearance of the bright colour of red wine. When the greatest part of the ammonia was evaporated the mixture acquired a greenish colour, and by repose a substance of the same colour as the solution was precipitated. The liquid filtered while hot and evaporated to dryness, afforded rudiments of crystals, of which the form could not be determined. White and brilliant parts were observed, and the rest of the matter was of a yellowish colour. Upon this residue I poured water, and agitated it with a spatula of platina. The least coloured portion was totally dissolved, and communicated a straw colour to the water. This fluid was acid, and possessed some of the properties announced by Cit. Brugnatelli. I shall presently describe the experiments to which I subjected it, the results of which properly examined, prove that it is not an acid formed by the cobalt. The two residues obtained in this experiment, one of a greenish, and the other of a yellowish colour, were proved to be not pure oxide of cobalt, as Citizen Brugnatelli affirmed, but a combination of that oxide with the arsenic acid.

The ammonia was evaporated by heat.

A precipitate fell and the filtered fluid afforded crystals by evaporation:

Part of the residue was taken up by water. It was acid,

but it was not cobaltic acid.

Exp. II. The ammoniuret of cobalt was exposed to the sun to lose its ammonia.

Flocculent precipitate.

The clear fluid filtered and evaporated to dryness left a matter soluble in water, which was acid, and the same as in Exp. I.

The first residue on the filtre was arseniate of cobalt.

Exp. III. Powdered zaffre was

Experiment 2. Having prepared a new quantity of ammoniuret of cobalt as in the former experiment, I submitted to spontaneous evaporation in a situation where the sun accelerated the volatilization of the ammonia. In proportion as the liquor evaporated a flocculent matter of a whitish rose colour fell down, which sensibly increased until the ammonia was evaporated. The fluid emitted no smell, but it had preserved a rose colour of a considerable beauty. I filtered it to separate the precipitate, and again evaporated the liquor to dryness. The remaining matter was dissolved in distilled water. This solution of a light rose colour was acid, and possessed the properties of the acid obtained in the former experiment,

The residue upon the filter was carefully examined, and ascertained to be the arseniate of cobalt.

Experiment 3. I took, as the author of the memoir himself did, one kilogram of zaffre, which was pulverised till it became an impalpable powder; I boiled it with three litres of distilled water for half an hour, and filtered the liquid while hot.

hot. The filtered fluid had a light colour, and perceptible taste. I evaporated it in a capsule of porcelain, and towards the end of the evaporation it became turbid. I continued to evaporate until the fluid was reduced to about one hectogram by cooling, and obtained needle formed crystals. The mixture was filtered with agitation; the crystals remained upon the filter, and the fluid passed very transparent of a bright yellow colour. Citizen Brugnatelli in making this experiment has not remarked the crystallization; he has only observed a white matter which was converted to a rose colour by the contact of the air, and supposed by him to be the oxide of cobalt. The needle formed crystallization which I obtained afforded a considerable disengagement of arsenic as soon as it was heated. When carefully examined it was proved to be the arseniate of cobalt, and not the oxide as had been announced. This fact is no doubt of little consequence to the discoveries of Citizen Brugnatelli; but nevertheless it might serve to support my opinion, if the results of my experiments were not more than sufficient to prove that the cobaltic acid has no existence.

boiled in water and filtered.

Crystals obtained by evaporation.

It gave out arsenic by heat; and was arseniate of cobalt.

The liquids of the 1st, 2d, and 3d experiments, which proved to be acid, and of the same nature, were subjected to the following trials, and comparatively with the arsenic acid.

Examination of the acid liquors.

First trial. This acid liquor is precipitated by sulphurated hydrogen, and by the alkaline hidro-sulphurets of a yellow colour similar to opiment, or the sulphuret of arsenic. This precipitate is in fact sulphuret of arsenic, and not sulphur precipitated, as Citizen Brugnatelli has supposed.

Sulphurated hydrogen throws down sulphuret of arsenic.

Second trial. It precipitates the ammoniuret of copper of a blueish green colour. This property belongs to the arsenic acid. The combination is known by the name of arseniate of copper.

It forms arseniate of copper with the ammoniuret of that metal.

3. Sulphate of copper mixed with this fluid affords a precipitate of the same colour as the ammoniuret of this metal. The arsenous acid also possesses this property not so eminently as the pretended cobaltic acid, but a similar precipitate may be obtained by using the arseniate of cobalt formed artificially. In this case the results are the same, and no difference can be perceived.

Its effect on sulphate of copper is the same as that of the arseniate of cobalt.

4. It precipitates the nitrate of silver of a white colour. The arsenic acid also enjoys this property.

It also acts like arseniate of cobalt on nitrate of silver;

and of mercury; 5. The nitrate of mercury is thrown down of a straw colour; and this phenomenon is also presented by the arsenic acid.

and lime water; 6. It precipitates lime water in a white coagulum insoluble in water, but not insoluble in an excess of acid, as Citizen Brugnatelli affirms; for in fact, it is re-dissolved with the same facility in the pretended cobaltic acid as in arsenic acid. I think the mistake of Citizen Brugnatelli arises from his not having used a sufficient quantity of acid.

and acetite and muriate of barites; from impurity. 7. It precipitates the acetite and the muriate of barites. I am assured that this precipitation arose from a small portion of sulphuric acid contained in the acid called cobaltic. The arseniate of cobalt also renders these solutions cloudy.

Precipitates in solution of galls. 8. It forms an abundant yellowish precipitate with the tincture of nut gall newly made. It is known that the arsenic acid produces the same phenomenon.

The pretended cobaltic acid is separable from water by alcohol, and even by alcoholic solution of arsenic acid. 9. The last trial. This last experiment appears to have been considered by Citizen Brugnatelli as the most characteristic of his cobaltic acid. He found that alcohol separated his acid from its aqueous solution, and also that the arsenic acid dissolved in alcohol enjoys the same property; by these processes he obtained his concrete acid. This property of the cobaltic acid at first surprised me; but presuming that I should discover the explanation by examining the acid thus precipitated, I subjected it to the following experiments.

This precipitated acid gave out arsenic by heat; 1. When heated upon charcoal by the blow pipe it emitted white vapours very easily distinguishable to be those of arsenic.

rendered borax violet; 2. A small portion heated with borax communicated a violet colour.

The precipitating alcohol has acquired arsenic acid. 3. This acid being precipitated by alcohol alone I examined the liquid, after having separated it by the filter. Sulphurated hydrogen produced an abundant yellow precipitate, which was found to be a sulphuret of arsenic.

The acid precipitate was nearly insoluble in water; 4. The separated acid was scarcely at all soluble in water.

but became soluble by addition of arsenic acid. 5. When mixed with a few drops of arsenic acid it dissolved completely, and resumed its original properties.

Hence the acid of Brugnatelli was arseniate of cobalt dissolved. From these trials I concluded, that the acid of Citizen Brugnatelli could be nothing else but the arseniate of cobalt dissolved in an excess of acid.

To put this beyond doubt I dissolved pure oxide of cobalt in the arsenic acid; I evaporated the solution to dryness, and added

added distilled water to the residue. After agitating the mixture it was filtered. The liquid thus obtained had a slight rose colour, and possessed all the properties of the cobaltic acid.

This acid when mixed with alcohol afforded an abundant precipitate, and the precipitate when collected presented all the phenomena exhibited by the concrete cobaltic acid.

It appears therefore certain from the results I have here detailed, that the so called cobaltic acid has no existence; that the simple combination of arsenic acid with oxide of cobalt has led Citizen Brugnatelli into an error, because this combination with excess of acid, is the substance obtained from zaffre by the methods described in this memoir.

in excess of acid.
A direct combination of oxide of cobalt and arsenic acid, had the colour, the precipitability, and all the properties of the supposed cobaltic acid.
Inference.

XIV.

*On the Plumb Line and Spirit Level, by EZEKIEL WALKER.
Communicated by the Author.*

Lynn Regis, March 18, 1802.

WHEN it is considered that the accuracy of astronomical observations depends greatly upon the exact manner of adjusting the instruments, any improvement in the method of making those adjustments may not be thought unworthy of a place in a philosophical Journal.

Importance of the adjustment of instruments.

The plumb-line and spirit-level are much used by astronomers, but from the great improvements made in the construction of the latter, the plumb-line seems to lose that preference which it had some years ago.

Plumb-line and spirit-level.

Mr. Ludlam says *, "I believe the spirit-level cannot ascertain the position of the axis" (of an instrument) "nearer than to a minute if so near." And when I first began to use the spirit-level for determining the position of the axis of a transit telescope, I found it nearly in the same imperfect state as mentioned by Mr. Ludlam: I was therefore very desirous of having some better method of making this adjustment.

Common spirit level said not to exceed the precision of one minute.

After having thought much upon the subject, I fixed on having a plumb-line suspended from the object end of the

Plumb-line to a transit instrument.

* Astronomical Observations, page 42.

telescope,

telescope, to pass over a point near the eye end. And in this manner a plumb-line was applied to it by Mr. E. Troughton, with his usual accuracy.

Described by Dr. Usher.

This way of levelling the axis of a transit telescope has since been described by Dr. Usher in the Transactions of the Royal Irish Academy.

Laid aside.

The Dr. speaks unfavourably of it, but many of his objections are ill founded, and it is probable that he never tried it. This method of applying the plumb-line gave me much satisfaction at that time, but some years afterwards it was totally laid aside for a ground spirit-level. The spirit-level which I now use is ground to a radius of 430 feet, with two indexes made of ivory, each about one-third of a minute in length; graduated to every two seconds. These are made to slide upon the level, that they may be brought over the ends of the bubble at pleasure; and no other adjustment is necessary.

Spirit level of 430 feet radius, with indexes graduated to two seconds.

Improved method of using it.

My method of using the spirit-level is not only more convenient than any other that I have met with, but the axis of an instrument may also be examined by it without altering the perpendicular screw, which is a matter of some consequence; because an instrument newly adjusted is subject to vary for some time after, by the changes which take place in the temperature of the air; consequently the adjusting screws should never be touched, except to make some necessary alteration.

Observe one end of the bubble; reverse the level, and observe again. The half difference of station is the error; to which bring the instrument.

My method is as follows. Having hung on the level, slide an index over one end of the bubble, and after it has remained at rest about a minute read off from the index the number of seconds a pointed out by the end of the bubble, then take off the level, invert the ends, and hang it on again, and if the same end of the bubble come to the same division (a) as before, the axis is level. But if the end of the bubble rest at any other division (b) on the index, then half the difference will be the error; and by means of the perpendicular screw, bring the end of the bubble half way between a and b , and the axis will be level without further trouble.

If the position be also determined by the other end of the bubble, the difference is seldom half a second.

The position of the axis may be also determined at the same time, by the other end of the bubble, and if the level be a good one, the results given by the two ends will seldom differ so much as half a second.

In

In consequence of an accident which happened to my spirit-level, I was under the necessity of having recourse once more to my plumb-line.

Plumb line resumed.

But Mr. Nicholson's paper on page 134, Vol. I. of his Journal, (quarto) made me look upon it with a very suspicious eye. My having been assured that my wire was of the best quality, did not remove those suspicions which that paper had raised in my mind of its being crooked. At last a method of trying this by experiment occurred to me, which was by reversing the sides of the wire, thus: after having made the wire to bisect the point near the eye end of the telescope, I turned that side of the wire which faced the south, to face the north, which was done very easily, by reversing that piece of brass to which the wire is fixed at the top, and at the same time turning the plumb line half round the same way. To my great surprize I found that my wire did not form an accurate right line by seven-seconds, though it was loaded with a proper weight.

Suspicion of flexure in the wire.

How verified.

The error from flexure was seven seconds.

I tried another piece of wire from the same bobbin, which deviated six seconds from a right line; I tried several other pieces before I found one that stood the test of this examination.

But after the error of a plumb-line has been thus determined, it is as good as if it were perfectly straight.

Remedy. But qu. if the error be invariable? W. N.

Another inconvenience that attended my plumb-line was this,—though the wire hung as near the point as possible without touching, yet the microscope could not be adjusted to view them both distinctly at the same time. An accident, however, put it in my power to remove this difficulty. Levelling the axis of the transit, one day, without any light in the room, except that which came through the opening in the roof behind me, I observed the shadow of the wire upon the telescope. By placing the microscope a little on one side of the wire, I saw the shadow very black and perfectly well defined. The shadow and the point being on the same plane, both objects were distinctly seen with the same adjustment of the microscope.

Difficulty of observing the wire and the stroke at the same time.

Removed by using the shadow of the wire.

The length of this plumb-line from the notch in which the wire rests at the top to the point is about $41\frac{1}{2}$ inches. The wire subtends an angle of 24 seconds at the point, and the point itself 52 seconds, consequently four seconds of the point are seen on each side of the shadow when the wire bisects the point.

Estimate error of adjustment by this plumb line.

point. Though these eight seconds measure only .00159 parts of an inch, yet an experienced observer will estimate with considerable exactness when the parts of the point seen on each side of the shadow are equal. Still it is not improbable, but a second or two may sometimes escape his notice on so small a scale.

Spirit level
much more ac-
curate.

The spirit-level has the advantage of so large a scale, that a second may be divided by the eye into many equal parts, and it is so easy in its application, that a few minutes only are sufficient for determining the position of the axis of an astronomical instrument, to less than a single second, as appears by the following observations.

Observations of
the level,

Position of the Axis shewn by the Spirit-Level.

By the end x.	By the end y.	"
1.75 -	- 1.7	$x + y \div 2 = 1.72$
1.65 -	- 1.85	$x + y \div 2 = 1.75$
2.1 -	- 2.2	$x + y \div 2 = 2.15$
1.7 -	- 1.77	$x + y \div 2 = 1.73$
1.6 -	- 1.6	$x + y \div 2 = 1.6$
East end of the axis dips		1.79

were fairly taken
and reported.

These ten observations are independent of each other, they were all taken at the same time, and none were rejected to make a show of precision, instead of shewing the truth.

Other levels of
Troughton
equally accurate.

I have had other spirit-levels ground by the same ingenious artist *, which were as good as this, though one of them was filled with spirits of wine.

* Mr. Edward Troughton, Fleet-Street, London. He in general uses ether.

XV.

*Description of a Machine for raising Ore from Mines. By Mr. T. ARKWRIGHT *, of Kendal, Westmoreland.*

A, Plate XV. is an endless chain formed of thin plates of iron, through the ends of which plates iron bolts are passed, which keep the sides of the chain at a certain distance asunder, and on which the buckets to contain the ore are suspended. **BCDE**, the buckets suspended on the iron bolts, **GHI**, three cylinders, round which the chain and buckets revolve. The two cylinders **GH** are placed above the shaft; the cylinder **I** within the mine. Their rims are so much higher than the body of the cylinders, as to admit the buckets to lie within the rims.

Construction of a machine for raising ore from mines.

As the endless chain and buckets are moved forwards by a power applied to the axis of the cylinder **G**, the bolts of the chain fall into notches made at regular distances in the rims of that cylinder, which preserve the chain from slipping.

As each empty bucket passes under the axis of the bottom cylinder **I**, it loads itself with ore instantaneously from a large box **K**, constantly filling by the workmen below, which box rests on two moveable pins **L**, at that end furthest from the wheel, and on an iron catch **M** at the other. The bucket thus filled ascends to the top of the cylinder **G**: and, in its passage betwixt the cylinders **G** and **H**, discharges its contents into a channel or receiver placed betwixt them, from whence they slide into a cart or receptacle placed underneath the inclined trough **N**. The empty bucket passes over the cylinder **H**, descends on the opposite side under the cylinder **I**, and loads itself again at **K**, as before mentioned; the buckets regularly loading and discharging themselves, whilst the cylinder **G** is kept in motion.

O is a ratchet-wheel on the cylinder, to prevent a retrograde motion in the chain.

* From "Transactions of the Society of Arts" for 1791. p. 277. The Society gave Mr. Arkwright a premium of twenty-five guineas for this invention.

Fig. 2. shews, upon a larger scale, the manner in which the box K above mentioned loads the buckets. P is an iron tooth projecting from the endless chain, which, pressing upon the catch R, underneath the box K, occasions that part of the box next the chain to sink down, and discharge into the bucket beneath it a quantity of ore sufficient to fill it. As the loaded bucket rises, it lifts the box K to its former place, till the operation is repeated by the next tooth upon the chain.

XVI.

Curious Properties of prime Numbers, taken as the Divisors of Unity. By a Correspondent.

To Mr. NICHOLSON.

SIR,

Introductory
letter.

IN the fourth volume of your Journal, page 403, (4to.) you inserted a curious property respecting the quotients resulting from the division of an unit by all prime numbers, not less than the number 7. I shall now lay before you two other properties equally curious, arising from similar divisions, and shall be much gratified, if in the hands of some of your learned readers or correspondents, this communication should, as I trust it will, prove really beneficial.

I am, SIR,

Yours, &c.

H. G.

March 22, 1802.

PRIME NUMBERS.

Law of the quo-
tients of unity
 \div by prime
numbers.

1. The first half of the quotient figures arising from the division of an unit by any prime number, not less than the number 7, will be the complements of the other half, to the number 9.

EXAMPLE

EXAMPLE I.

$$1 \div 7 = \cdot 14285\dot{7}$$

or

$$1 \div 7 = \left\{ \begin{array}{l} \cdot 142 \quad . \quad . \quad 1\text{ft.} \\ 857 \quad . \quad . \quad 2\text{d.} \end{array} \right\} \text{half.}$$

$$\text{Quotient figures added} = \underline{\underline{999}}$$

EXAMPLE II.

$$1 \div 29 = \cdot 034482758620689655172413793\dot{1}$$

or

$$1 \div 29 = \left\{ \begin{array}{l} \cdot 03448275862068 \quad . \quad 1\text{ft.} \\ 96551724137931 \quad . \quad 2\text{d.} \end{array} \right\} \text{half.}$$

$$\text{Quotient figures added} \quad \underline{\underline{9999999999999}}$$

Remark.—From hence it appears, that if half such like quotients be found by division, the other moiety may be obtained by a simple addition only.

2. The first half of the dividend figures (or successive remainders) arising from the division of an unit by any prime number, not less than the number 7, will be the complements of the other half to the prime divisor. Law of the remainders of unity \div by prime numbers.

EXAMPLE III.

The prime divisor being 17.

$$\text{Then } 1 \div 17 = \cdot 058823529411764\dot{7}$$

or

$$1 \div 17 = \left\{ \begin{array}{l} 1 \ 10 \ 15 \ 14 \ 4 \ 6 \ 9 \ 5 \ 1\text{ft. half of div.} \\ \cdot 0 \ 5 \ 8 \ 8 \ 2 \ 3 \ 5 \ 2 \ 1\text{ft. half of quots.} \\ 16 \ 7 \ 2 \ 3 \ 13 \ 11 \ 3 \ 12 \ 2\text{d. half of div.} \\ 9 \ 4 \ 1 \ 1 \ 7 \ 6 \ 4 \ 7 \end{array} \right.$$

$$\text{Divs. added} = \underline{\underline{17 \ 17 \ 17 \ 17 \ 17 \ 17 \ 17 \ 17}}$$

$$\text{Quots. added} = \underline{\underline{9 \ 9 \ 9 \ 9 \ 9 \ 9 \ 9 \ 9}}$$

EXAMPLE IV.

The prime divisor being 23.

$$\text{Then } 1 \div 23 = \cdot\dot{0}43478260869565217391\dot{3}$$

or

$$1 \div 23 = \left\{ \begin{array}{l} 1 \ 10 \ 8 \ 11 \ 18 \ 19 \ 6 \ 14 \ 2 \ 20 \ 16 \ \text{divs.} \\ \cdot\dot{0} \ 4 \ 3 \ 4 \ 7 \ 8 \ 2 \ 6 \ 0 \ 8 \ 6 \ \text{quots.} \\ 22 \ 13 \ 15 \ 12 \ 5 \ 4 \ 17 \ 9 \ 21 \ 3 \ 7 \ \text{divs.} \\ 9 \ 5 \ 6 \ 5 \ 2 \ 1 \ 7 \ 3 \ 9 \ 1 \ \dot{3} \ \text{quots.} \end{array} \right.$$

Divs. added	23	23	23	23	23	23	23	23	23	23	23
	9	9	9	9	9	9	9	9	9	9	9

Remark.—From hence it appears, if half the dividends be found (and they are easily obtained by the continual addition of a few of the first quotient figures) the remainder regularly succeed them as complements of the former.

Observation.—The result of the divisions of an unit by the prime numbers 11, 31, 37, 41, &c. appears at first sight to deviate from the general law above laid down, but in fact it is subservient to it, as will appear from the following

EXAMPLE.

The prime divisor being 41.

$$\left\{ \begin{array}{l} 1 \ 10 \ 18 \ 16 \ 37 \ \text{dividends.} \\ \cdot\dot{0} \ 2 \ 4 \ 3 \ 9 \ \text{quotients.} \\ 40 \ 31 \ 23 \ 25 \ 4 \ \text{dividends.} \\ \cdot\dot{9} \ 7 \ 5 \ 6 \ 0 \ \text{quotients.} \\ 2 \ 20 \ 36 \ 32 \ 33 \ \text{dividends.} \\ \cdot\dot{0} \ 4 \ 8 \ 7 \ 8 \ \text{quotients.} \\ 39 \ 21 \ 5 \ 9 \ 8 \ \text{dividends.} \\ \cdot\dot{9} \ 5 \ 1 \ 2 \ 1 \ \text{quotients.} \\ 3 \ 30 \ 13 \ 7 \ 29 \ \text{dividends.} \\ \cdot\dot{0} \ 7 \ 3 \ 1 \ 7 \ \text{quotients.} \\ 38 \ 11 \ 28 \ 34 \ 12 \ \text{dividends.} \\ \cdot\dot{9} \ 2 \ 6 \ 8 \ 2 \ \text{quotients.} \\ 6 \ 19 \ 26 \ 14 \ 17 \ \text{dividends.} \\ \cdot\dot{1} \ 4 \ 6 \ 3 \ 4 \ \text{quotients.} \\ 35 \ 22 \ 15 \ 27 \ 24 \ \text{dividends.} \\ \cdot\dot{8} \ 5 \ 3 \ 6 \ 5 \ \text{quotients.} \end{array} \right.$$

A table of the quotients and dividends arising from all prime numbers under 1000 is nearly completed, and will be at the service of the public whenever it shall appear sufficiently beneficial.

SCIENTIFIC NEWS.

*Extract of a Letter from Mr. W. WALKER, Lecturer on the
Eidouranion, on the new Planet Ceres.*

To Mr. NICHOLSON.

S I R,

42, Conduit-street, Hanover-square,
London, 25th March, 1802.

THE interest that I find excited, both in public and in private, by the discovery of a new planet, induces me to offer you the latest observations by which it can be ascertained, that the necessary publication of your most valuable Journal will admit.

Since the 15th of this instant March, I have regularly observed it; and by the following memorandums it will be readily found by any of your readers, who are solicitous, and provided with a night telescope, or a common spy-glass, for it is not visible to my unassisted eye.

New planet
Ceres.

Observations on
the position of
the neighbouring
stars, by means
of which the
planet may be
easily found.

If at 9. 10. 11. 12. 1. 2. or 3. in the night, a line is drawn from Theta Lionis, through Beta or the Lion's Tail: at the same distance, and to the left, but a little above this termination, a small configuration of stars will be perceived of the following description: Two stars of considerable brightness will be found to form one side of an equilateral triangle, and a very small star the other point of this figure. Between these larger ones and the point will be seen two minuter stars, which, with the star at the point, form also an equilateral triangle. The Ceres is passing through this cluster. On the 15th instant the planet was to the east of the smallest star at the point of the triangle. I have regularly observed it on the 16th, 20th, 21st, 22d, and this evening the 25th, when it is arrived between the two westernmost or largest stars of the above configuration.

By continuing this line it may easily be discovered for a few nights to come. The planet is as bright as most of the stars in its neighbourhood. But although I have observed it with magnifying powers from forty to above one thousand times, I must hesitate in declaring it to have a defined diameter

ter or disc, different from the neighbouring stars; whilst the Georgium Sidus in its neighbourhood leaves no doubt of a decisive magnitude.

I am, SIR, Your's, &c.

W. WALKER.

The following is the right ascension and declination of the planet (Ceres), by Mr. Zach of Gotha, for the commencement of the next month*.

	Right Ascension in Time.	Right Ascension in Degrees.	Declination North.
April 3	12 0' 12"	180° 3'	18° 6'
6	11 57 54	179 29	18 9½
9	— 55 45	178 56	18 10
12	— 53 46	178 26	18 9
15	— 51 37	177 59	18 5
18	— 50 20	177 35	17 59

Extract of a Letter from M. ZACH, Director of the Observatory of Gotha, to C. MECHAIN, of the Institute, Administrator of the Observatory at Paris.

Disc of the planet Ceres.

Suspicion of two satellites.
Dense atmosphere.

M. Schroeter, at Lilienthal, observes with his great telescope the disc of the new planet Ceres to be about two seconds. He also suspects the existence of two satellites. The planet is enveloped in a very thick atmosphere, for it appears to be surrounded with much nebulosity. I am very curious to know what Dr. Herschel will tell us concerning it. In the mean time, I thought it proper to write this in haste, &c. &c.

Elements.

Elements of the new planet, corrected by M. Gauss, from the latest observations:—

Diurnal heliocentric tropical motion 770' 7376

Tropical revolution 1681 days 12 hours 9 sec.

Decade Philos. No. 15. An. x.

* A small map of the stars above described was given in Mr. Walker's letter; but time did not admit of engraving it. W. N.

Spider's

Spider's Webs to form the cross Wires in the Eye Piece of Astronomical and other Instruments.

The smallest silver wire I have heard of was rather thinner Smallest wires than one thousandth part of an inch; but every specimen I have seen was considerably thicker. This has not been supposed of much consequence in the construction of plumb lines; but it is very desirable that the wires in the focus of microscopes should be as fine as possible. In a description of instruments in the Cabinet of the Grand Duke of Tuscany, arranged by the Abbé Fontana, and written by Ami Angand in one of the Journals de Physique above twenty years ago, to which I must refer the reader to the index of that useful work, not having a whole set at hand; mention is made of spider's webs Spider's webs used in microscopes. in the focus of microscopes for measuring; and long since, when upon observing that the single thread of the silk worm is very slender, I mentioned its use to my old friend J. H. de Silk worms threads. Magellan, F. R. S. he informed me, that organized substances had been tried in astronomical telescopes, and rejected, because the solar image was found to burn them.

I suppose this must have been taken for granted by himself Troughton's application of spider's webs to astronomical telescopes. or somebody else without trial; for Mr. Edward Troughton, whose talents are indefatigably directed to every thing that can insure the precision and accuracy of astronomical instruments, has for some time applied the webs of young spiders to the purpose above-mentioned. He takes hold of a short length of the web by means of a forked stick, and then carefully applies it to the marks on the frame or ring intended to hold it, where it adheres by the previous application of a little varnish. These lines have a beautiful aspect for their delicacy, precision, and evenness.

That the solar focus should not injure them is a fact of some Curious fact that the burning lens does not destroy small wire. remark; which I should be disposed to ascribe to their transparency, if I had not been assured by an eminent philosopher, that fine metallie wires were not affected by Parker's great lens, which instantaneously fused and burned thicker wires and masses. What may be the theory of this? Will the ascending current of air cool a small wire more speedily than a larger, Conjectures. of which the internal parts bear a greater proportion to the surface? or does the extreme light ignite and perforate the

small wire, so as to escape with rapidity on the opposite surface, and keep down the maximum of temperature? &c.
Opera desiderantur, non verba. W. N.

Thick Iron burned in Oxygen.

Combustion of iron in oxygen.

Mr. Accum informs me, that a thick piece of iron or steel, such as a file, may be burned in oxygen gas, if it be made very sharp pointed, and a small piece of wood be stuck upon its extremity, which is to be set on fire previous to immersion into the gas.

Extreme accuracy of tuning Musical Instruments.

Very exact process for tuning musical instruments.

About a year ago — Huddleston, Esq. shewed me an excellent monochord, with improvements for ascertaining the precise lengths, and securing the equable tension of the string, which I should be glad if I had an opportunity of communicating. I was much gratified by his method of tuning unisons to a degree of precision which the direct power of the ear could assuredly never command. 1. He tunes his string (*a*) (to the tone given by a fork, or otherwise) so as to have no beat or undulation, but to be as nearly unison as the sense can distinguish; 2. he tunes another string (*b*) a very small quantity sharper (or flatter) so as to afford an evident beat; 3. he sets a small pendulum, or bullet and thread, to vibrate with the beat; 4. he tries his fork with the last string (*b*) and observes the beat by the pendulum, unaltered; 5. if the beat be slower than before, it follows that the first string (*a*) is still too flat, because the fork is nearer unison with the sharp string (*b*); — if quicker, then (*a*) is too sharp. I heard four forks struck in quick succession, which had been tuned by this process; and though there was only the fundamental, with its third, fifth, and octavo, the effect was delightful.

Strange influence of organ pipes upon each other.

The same gentleman mentioned a singular, and I believe unobserved fact, relative to the combination of musical undulations in the air. Two contiguous organ pipes, both excellent, stopped diapason C and C sharp, in a valuable instrument he possesses, govern each other, so that if C be first sounded and held, the C sharp will give unison to C whenever its key is struck: but if C sharp alone be sounded and held, the C pipe will give C sharp when its key is struck. I will not venture to speculate upon this.

INDEX.

A.

ABERNETHY, Mr. 26
Accum, Mr. Fred. his entertaining chemical experiments, with new facts and observations, 295.—On combustion of thick iron in oxygen, 320
Acetite of barites in crystals, 298
Achard, 204
Acid, fluoric, how to obtain it pure, 299.—benzoic, in vanilloe, 300.—Of cobalt, Darracq's proof that it is arseniate of cobalt, 238, 304, 309.—Gallic, Fiedler's method of rendering it pure, 236.—Muratic, 235.—Sebacic, Cit. Thenard on, 34.—Zoonic, stated to be merely the acetous, 238
Adamantine spar found in America, 151
Agricultural Society of the department of the Seine, 157
Agriculture, memoirs of, 79, 160
Air, its influence in vegetation, 157
Alban, 119
Albumen used for clarifying, 256
Algaroth powder, 24
Amber, its excellence as a vehicle for oil pigments, 261.—Floating, in liquids is not made to circulate by currents, 82
Amoreti, opuscoli scelti da, 78
Antimonialis, pulvis, 22
Apparatus, hydraulic of Mr. Wm. Close, 27, 145.—For bleaching, 121, 128.—For shewing the transmission of heat through fluids, 167
Argand, 319
Arkwright, Mr. T. his machine for raising ores out of mines, 313
Arseniates of copper and iron, 258
Affignats, French, 118
Astronomy, Gregory's, 75
Athenas, 119
VOL. I.—MAY, 1801.

Atmosphere, its component parts little variable, 41, 43
Atlas of the south of Europe, by Chaulaire, 79
Aubert, Mr. 193

B.

Babington, Dr. 26
Baillie, 71, 104
Banks, Sir Joseph, 130
Barbers, Persian and Chinese, 50
Barites, acetite of, in crystals, 298.—Nobilis, 151
Barometer, why it varies so little near the equator, &c. 278.—Why farmers disregard it, *ib.*—Rules for it, 279
Battery, electric, charged by galvanism, by Volta, 140.—Large, charged with galvanism by Von Marum, 155
Baumé, 114
Beddøes, Dr. 43.—On the weather, &c. 98
Beet sugar, treatise on, 75
Bennet, Rev. A. 143.—Early experiments made by him on electricity excited by contacts of metals, 184
Benzoic acid, in vanilloe, 300
Bergmann, 34
Berthollet, 24, 43, 109, 118, 119, 235, 303
Biot, Cit. on the motions of camphor on water, 51
Blair, Mr. his popular lectures, 240
Bleaching of paper by Loysel, 148
Blue oxide of iron, native, 153.—Prussian, Des Mortiers on, 75
Blindness, recovery from, with some curious incidents, 60
Bode, 194, 196
Boerhaave, 204

INDEX.

- Bones, Proust on the quantity of nutriment they afford, 100.—Of fish, afford one sixth part more phosphoric acid than those of quadrupeds, 299
- Bonhomme, M. 25
- Book-keeping, Kelly's, 156
- Books, catalogue of, 160
- Borda, his circle of reflection, 6
- Bossut, on arches, 69
- Boncher, 159
- Bournon, Count de, 258
- Bourlier, 303
- Bouvard, 70
- Boyle, Robert, 265
- Bradley, Dr. 59
- Bread and butter, 150
- Brugnatelli, on the motions of odorant bodies on water, 51.—His supposed cobaltic acid, 304
- Bruckmann, Dr. 151
- Buffet, Stephen, 97
- Burkhardt, Cit. 194
- C.
- Cadet de Vaux, 157, 160, 212
- Camphor, Cit. Prevost on its remarkable motions on water, 51.—Motionless on mercury, 301.—Does not move on water at a low temperature, *ib.*
- Caloric, Socquet on, 76
- Capper, Col. on winds, 75.—On the causes that influence the weather, 275
- Carangeau, his graphometer, 132
- Carny, 119
- Carp, its air bladder when recent contains common air, and not azote, 299
- Carradori, 51, 52.—On the influence of oxygen on germination, 204
- Carriages of every description may be conveyed upon rail roads, 222
- Cataracts, case of recovery from blindness by, 57
- Cavallo, 144.—On the electricity produced by contact of metals, 184
- Cavendish, 43
- Cels, 159
- Ceres, the new planet, 72, 193.—A popular account of the methods of ascertaining its elements, &c. by the Rev. Wm. Pearson, 284.—Its place, 318.—Suspicion of two satellites, *ib.*—Very dense atmosphere—elements of Gauss, *ib.*
- Chamberlayne, Mr. 59
- Chancey, 160
- Clanlaire's atlas of the south of Europe, 79
- Chaptal, 118, 160
- Charcoal, used by Davy for galvanism without other solids, 144
- Chaffiron, 159
- Chaumontel, 159
- Chenevix, Rich. Esq. on James's powder, and a similar preparation in the humid way, 22.—On muriatic acid, 235, 258
- Chefelden, comparison of his famous case of blindness, and another more recent case, 61
- Chemistry, elements of, 75
- Chlorophane, 151
- Chromate of iron discovered in France, 238
- Cinnabars, experiments on, 113.—In the humid way, 299
- Circles of reflection, of Mayer, Borda, and Mendoza, 4
- Cline, Mr. 105
- Cloquet, Cit. 281
- Close, Mr. Wm. his hydraulic apparatus acting by the syphon, 27.—the same analyzed, 145
- Clouds, planetary and luminous of the sun, 14, &c.
- Cobaltic acid is merely the arsenical, 238
- Colours how depraved by ficcative oils, 261
- Columbium, a new metal, 52
- Comet, 69
- Conductors of heat, 241
- Cooper, Mr. Astley, on deafness, and the perforation of the membrana tympani, 102
- Copal, its excellence as a vehicle for oil pigments, 262
- Copper, arseniate of, 258

INDEX

Copying process, 147
 Corindon found near Philadelphia, 151
 Corrugations, solar, 18
 Cossigny, 160
 Coulomb, on magnets, 71
 Cream used to clarify spirits, 257
 Crell, 34.—His process for obtaining seb-
 acic acid described and examined, 37,
 151
 Creusé Latouche, 160
 Crichton, Dr. 26
 Cruickshank, Mr. Dr. Priestley's reply to
 his observations, 181
 Crystals, instrument for measuring their
 angles, 132.—Le Blanc's method of
 obtaining them very beautiful and large,
 191
 Currents in hot liquids whether they exist,
 by Dr. Thomson, 81

D.

Davy, Mr. H. his new eudiometer with
 sulphate of iron, 41.—On the absorp-
 tion of nitrous gas by the sulphate and
 muriate of iron, 107.—Lectures on
 chemistry, 135.—His pile for galva-
 nism with one metal only, 143.—With
 two metals, and the current reversed by
 changing the fluid, *ib.*—On a galvanic
 combination with charcoal and fluids,
 144.—New and curious inflammation
 of combustibles by, 296, 297
 Darcet on a pigment with cheese, 212
 Dark glasses, their place supplied by li-
 quids, 21, 224
 Darracq, Cit. on the supposed cobaltic
 acid, 238.—His examination of the
 supposed cobaltic acid, and experiments
 shewing it to be arsenic acid and cobalt,
 304, 309
 Deafness, Mr. Astley Cooper on, 102
 Decandolle, 205
 De Lafons, Mr. his free escapement for
 time pieces, 251
 Delambre, Cit. account of the transactions
 of the Institute of France, 69
 Delametherie, 135
 Delineation of objects, advantages of an
 early habit of, 282

Delong, 159
 Denorgelles, *ib.*
 De Saussure, 143
 Desferoizilles, 123
 Dijon, process of for obtaining sebacic acid
 described and examined, 37
 Discovery of new planets, how accom-
 plished, 285
 Dolomieu, on the art of making gun-
 flints, 88
 Doubler, Electrical, 185
 Drains, cause of their offensive smell, 280
 Drying oils, Mr. Sheldrake on, 259
 Duc-la-Chapelle, 70

E.

Earth eaten by certain savage nations,
 152
 Edgeworth, Maria, 281
 Edgeworth, R. L. Esq. on the practica-
 bility of a general system of rail-roads,
 221.—His cheap, simple, and portable
 instrument, for taking objects in per-
 spective, 281
 Electricity from mere contact of metals,
 135, 184
 Electrometer of Volta, 136
 Elements of Chemistry by Murray, 75,
 239
 Emerald found in France, 238
 Engine for raising water by pressure, by
 Mr. Trevithack, 161
 Englefield, Sir Henry, on the planet Ceres,
 197
 Entertaining experiments, 295
 Escapement for watches, a new and free
 by Mr. De Lafons, 251
 Eudiometer, new, by Davy, 41
 Euler, Mr. I.
 Eustachian tube, remedy for its closure,
 105

F.

Fat, acid of, Cit. Thenard on, 34
 Fiedler on the purification of gallic acid,
 236
 Filtering stone, a bad contrivance, 255
 Filtration, process of, 229, 253

INDEX.

Fire, spontaneous of a beautiful green, 296.—Under water, *ib.*—Other curious combustions, 297

Fish bones abound with phosphoric acid, 299

Flints, gun, art of making, 88

Fluids, the amber or other floating bodies in them, are not moved by currents, 82.—Experiments on their power of transmitting heat, by Mr. John Murray, 241.—Semi-opaque, used by Dr. Herschel, instead of dark glasses, 224

Fluoric acid contains lead; how to purify it, 299

Focus, solar, curious fact respecting it, 319

Fontana, 319

Forks, musical, exquisitely tuned, 300

Fourcroy, 119.—His error in pointing out the air bladder of the carp as a source of azote, 299

Franklin, Dr. 150

Frogs remarkably affected by the presence or absence of light, 301.—Converted into clear jelly by potash, *ib.*—How affected by the gases, 302

G.

Garnet, red, 44

Garnier, 168

Gallic acid, purification of, 236

Gallitzin, Prince, 44,—151

Gas, nitrous, its absorption by the salts of iron, 107

Gauss, his elements of the new planet Ceres, 195,—318

Germination, how affected by air, 157.—How affected by oxygen, 204

Gough, Mr. J. on prime numbers and resolution of a number into all its factors, 1

Graphometer of Carangeau, description and plate, 132

Gregory's astronomy, 75

Grutmacher, 34

Galvanism, Volta's theory of, 135.—Used

to charge the Haarlem battery, 173, —198.—Said to be the same as magnetism, 234

Guillemard, 151

Gun-flints, art of making, 88

Guyton, 34, 119

H.

Haley, his escapement, 251

Haller, 34

Hamilton, Dr. 62

Hatchett, Charles, Esq. his discovery of the new metal columbium, 32, 33

Hävi, 132, 193

Heat, its transmission downwards through fluids included in a vessel of ice, &c. by Mr. Murray, 165, 241

Herschel, Dr. on the nature of the sun, 13.—Uses liquids instead of dark glasses, 21,—151.—His darkening apparatus by fluids, 224

Hydrogen, found from burning it, 129.—Sulphurated acts as an acid, 303

Hydrofulphuret of soda, 303

Higgins, Dr. on the musical sound produced by the flame of hydrogen, 129

Hoffman, F. 114

Hoffmansegg, Count, 151

Hornblower, his hydraulic bellows, 219

Houdart, 159

Huber, on the influence of air in vegetation, 157

Huddleston, Esq. his excellent monochord, 320.—Very exact method of tuning, *ib.*—Strange influence of two pipes of his organ on each other, *ib.*

Humboldt, Cit. 109.—On the earth eaten by certain savage nations, 152

Humidity in galvanism said to act only as a conductor, 138

Hutton, Dr. his theory of rain, 91

Hydraulic apparatus of Mr. Cloze, 27.—The same analyzed, 145

Hydraulic bellows of Hornblower, 219

Hydrophanes, 92

INDEX.

I.

- James's powder, Chenevix on, 22
 Illogan in Cornwall, new hydraulic engine
 at, 162
 Indentations, solar, 18
 Ink made fit for copying by addition of
 sugar, 147
 Institute, national of France, 69
 Iron, native blue oxide of, 153.—Neu-
 tral phosphate of 238.—Arsenate of,
 258.—Thick, burned in oxygen, 320

K.

- Karsten, Dr. 259
 Kelly's book-keeping, 156
 King, Mr. 99
 Kirwan, 130
 Klaproth, 234, 258
 Knap, 34

L.

- Labillardiere, his account of earth eaten
 by the new Caledonians, 152
 Lacepede, 258
 Lalande, Jerom on the catalogue of 50,000
 stars, 70,—195
 Lanthorn, magic, great improvement in
 its use in the Phantasmagoria, 147
 Lasterie, 159
 Laughter, 150
 Le Blanc, his method of obtaining large
 and fine crystals, 191
 Le Blond, 160.—His varnish, 267
 Lectures at the Royal Institution, by Dr.
 Young, 239
 Lelievre, Cit. 238
 Lens of Parker does not burn very small
 wire, 319
 Leon. da Vinci, his oil painting, 264
 Lewis, Dr. 261
 Lichtenberg, 71
 Lime, pure, its crystallization, 302
 Liquids, Parmentier on the methods of
 clarifying them, 228, 253.—Used by
 Herschel in telescopes instead of dark
 glasses, 21, 224
 Lomazzo, 264
 Loyfel on bleaching paper, 148
 Ludlam, on the common spirit level, 309

M.

- Machine for raising ores from mines, by
 Mr. T. Arkwright, 313
 Macquer, 202
 Magellan, I. H. de, 319
 Magic Lanthorn improved in the Phan-
 tasmagoria, 147
 Magnet, said to produce the same effect
 as the galvanic pile, 234
 Manuscript, easy process for copying, 147
 Maratti, Carlo, 268
 Marchais, 119
 Mariti, 43
 Maskelyne, Dr. 193
 Mayer, his circle of reflection, 5, 71
 Mechain, 70
 Mendoza, Mr. his improved reflecting
 circle, 4
 Mercury curiously oxidized by galvanism,
 178.—Conducts heat downwards, 241
 —Its red sulphuret in the humid way,
 299.—Howard's fulminating, ib.
 Messier on a comet, 69
 Metal, new, discovered by Ch. Hatchett,
 Esq. and called Columbium, 52
 Metals, Bennet on the electricity pro-
 duced by their contact, 184
 Milk, paint, 212
 Mitchell, 71
 Molt, Baron de, 153
 Monge, 51
 Monochord of —Huddleston, Esq. 320
 Moreau, St. Méry, 160
 Motors, electric, 136
 Mudge, his escapement, 251
 Murray, Mr. John, on heat communi-
 cated downwards through water, 165.
 —His elements of chemistry, 239.—
 On the transmission of heat downwards
 through fluids contained in vessels of
 frozen water, 241
 Muriate of tin, fuming, improved prepa-
 ration of, 117
 Muschenbroeck, 204
 Muscular motion, 203
 Musical instruments, extreme accuracy of
 tuning, 320
 Musical sound produced by burning hydro-
 gen, 129

INDEX.

N.

- Newton's theory of gravitation arose from a common occurrence, 150
 Nicholson, 311
 Nitrous gas, its absorption by the salts of iron, 107
 Nitrous oxide, 99.—Its alarming effects on Mr. James Stodart, 225
 Nodules, solar, 18
 Nonius, flying, of Mendoza, 8
 Numbers, Gough on primes and factors, 1.—Curious properties of, 314

O.

- Observations of Piazzi and of Zach, on the new planet Ceres, 288, 294.—On the plumb-line and spirit-level, 312
 Ochres, natural production of, 112
 Odorous substances, their motions on the surface of water, 51
 Oil, its strange effect on the extrication of gas by galvanism, 201.—Conducts heat downwards, 241.—Used by painters, on its improvement by Mr. Sheldrake, 259.—Burned on water, 297
 Olbers, Mr. 193, 287
 Openings, in the solar atmosphere, 14
 Organ pipes, strange influence of, upon each other, 320
 Oriani, 194
 Otomagues, savages who eat a mere earth, 152
 Oxide, nitrous, 99.—Mr. Stodart feriously affected by breathing it, 225

P.

- Paint, with milk, &c. 212
 Paper, bleaching of, by Loyfel, 148
 Papin's digester, 100
 Parmentier, 157.—On the clarifying of liquids, 228, 253
 Payen, 303
 Pearson, Dr. on James's powder, 22, 23
 Pearson, Rev. Wm. his account of the new planet Ceres, 284
 Perez, Cit. Y, on radical vinegar, 39

- Pernety, 213
 Perspective instrument, cheap, simple, and portable, by R. L. Edgeworth, Esq. 281
 Pfaff, Professor, 173
 Phantasmagoria, 147
 Phantasms, optical, ib.
 Philipsthal, Mr. his phantasmagoria, 147
 Philosophical Transactions, 73
 Phipson, Mr. 198
 Phlogiston, 199
 Phosphate of iron, native, 238
 Phosphorus, new and curious inflammations of, 296, 297.—Plentifully obtained from fish bones, 299.—Moves spontaneously on mercury, but camphor, &c. do not, 301
 Piazzi, M. of Palermo, his new planet, 72, 193, 196, 287
 Pictet. Cit. 281, 135
 Pile, galvanic, its capacity compared with electric apparatus, 175, 177
 Planet new, see Ceres, 72
 Platina fused by galvanism, 178
 Platt, M. 59
 Plumb-line for astronomical instruments, its limits of accuracy, by Mr. Ez. Walker, 309
 Pons, 70
 Pores, solar, 18
 Pott, surgeon, on the cataract, 65
 Powder, James's, Chenevix on, 22
 Prevost, Cit. Benedict, on the motions of camphor, &c. on water, 51
 Priestley, Dr. 41, 108.—His reply to Mr. Cruickshank, and defence of phlogiston, 181.—On the pile of Volta, 198
 Prime numbers, curious properties of, 314
 Prognostics of the weather from animals, &c. 280
 Proust, Mr. on the nutriment afforded by various bones, 100.—On metallic sulphurets, 109, 269, 258
 Prussian blue, Des Mortiers on, 75
 Pulvis antimonalis, 22
 Pyrites, their nature amply investigated, 109, 269

INDEX.

Q.

Quartz and flint, their difference, 89, 93

R.

- Rabbits, use of their whiskers, 154
 Rags, bleached, 119
 Rail-roads, general system of, by R. L. Edgeworth, Esq. 221
 Razor, to chuse a good one, 47.—To sharpen, 48.—On the choice and use of, 210 — Why it cuts better when heated, 211
 Reflection, circles of, 4
 Rhades, 34
 Ribaucour, 119
 Ridges, or elevations in the luminous matter of the sun, 17
 Rollo, Dr. 204
 Round, Mr. 104
 Royal Society, transactions of, 73
 Ruler, plain graduated, its use for perspective, 284
 Rumford, Count, 81, 165

S.

- Schroeter, Mr. of Lilienthal, his observations on the new planet Ceres with his great telescope — dense atmosphere — suspicion of two satellites, 318
 Scott, Mr. 68
 Seasons, how far influenced by the changes in the sun itself, 20
 Sebacic acid, Thenard on, 34
 Seeberg observatory, 288
 Segner, 34
 Senebier on the influence of air in vegetation, 157
 Seybert, Adam, 151
 Shallows, in the solar luminous clouds, *ib.*
 Shaving, art of, 47
 Shelldrake, Mr. on the nature and preparation of drying oils, with a view to the improvement of such as are used as vehicles for painting, 259
 Shocks, galvanic, 180
 Silex and quartz, their difference, 89, 93. —Ignarius, 89

- Sloane, Sir Hans, 52
 Society of arts, 251
 Socquet on caloric, 76
 Soda, hidrosulphuret of, its crystals by Vauquelin, 303
 Soldier, Proust on the subsistence of, 100
 Sound, musical, produced by burning hydrogen, 129
 Steam engines, recommended for drawing carriages, 223
 St. Genis, 157
 Stodart, Mr. James, seriously affected by breathing the nitrous oxide, 225
 Spar, adamantine, found in America, 151
 Spider's wax, 299.—Webs instead of the cross wires in the foci of telescopes, 319
 Spirit level, its limits of accuracy, by Mr. Ez. Walker, 309,—312
 Sugar, its effect in ink, 147
 Sulphurets, native and artificial of iron, by Proust, 269.—Metallic, their nature explained by Proust, 109
 Sun, Herschel's observations on its nature, 13.—Suspected to have a bright and a dark side, 21

T.

- Telescopes, darkening apparatus for, by fluids, 224
 Tellurium, asserted to be the metal antimony only, 234
 Thenard, Cit. on sebacic acid, 34, 238
 Thomson, Dr. Tho. on the supposed currents in hot liquids, 81
 Thunder, remarkably well imitated by a sheet of iron, 149
 Tin, fuming muriate of, improved preparation of, 117
 Transactions, philosophical, 73
 Transit instrument, comparative excellence of the plumb line and spirit level with regard to it, and adjustment, &c. by Mr. Ez. Walker, 309, 312
 Trenethick wood tin mine, 165
 Trevithack, Mr. his powerful engine for raising water by pressure of a column inclosed in a pipe, 161
 Tromsdorff, Professor, on a new mineral resembling

INDEX.

resembling the hyacinth, 44.—On the crystallization of pure lime, 302
 Troughton, Mr. Edward, 11, 287, 312.
 —Uses spiders webs for the cross wires of telescopes, 319
 Tuning, very accurate process of, 320
 Turpeth mineral, 114

V.

Van Marum, charges a large battery by galvanism, 155.—His experiments, by which the great Haarlem battery was instantly charged by the galvanic pile, 173
 Van Mons, 236, 238
 Varnish of Le Blond, 267
 Vauquelin, 109.—On the earth eaten by certain savage nations, 152.—Account of a blue oxide of iron, 153, 238, 258.
 —On the crystals of hidrosulphuret of soda, 303
 Vegetation, how affected by air, 157
 Venetian school; what occasioned the superior brilliancy of their pictures, 265
 Venturi, Cit. on camphor, &c. 51
 Villele, 159
 Violets, syrup of, restored by oxygen, 298
 Vinci, L. da, his oil painting, 264
 Vinegar, radical, easy process for making, by Perez, 39
 Volta on the motions of odorant bodies on water, 51, 130.—His theory of galvanism, 135, &c.—Pile of, Priestley on the, 118
 Voloky, Professor, on whiskers, 154

U.

Umbel, 112
 Usher, Dr. on the application of a plumb-line to the transit instrument, 310

W.

Walker, Ezekiel, his experimental exa-

mination of the plumb line and spirit-level, 309
 Walker, Mr. William, on the planet Ceres, 317
 Ware, Mr. James; on a case of recovery from blindness, 57
 Water, whether it be in truth decomposed by galvanism, 198.—Raised by a new and powerful engine of Trevithack, 161
 Wax, vegetable, 275.—From spiders, 299
 Weather, Capper on the causes that influence it, 275
 Welter, 119
 Wenzel, Baron de, 64
 Whiskers, their use in quadrupeds, 154
 Wind, or gas, from the sun's body, 15
 Winds, Col. Capper on the, 75
 Wiegleb, 114
 Winthorp, Mr. 32
 Wire, the smallest size, 319.—Remarkable fact that the powerful lens of Parker does not burn it if very slender, ib.
 Wire, edge, 49
 W. N. on the processes of common life: Art of Shaving, 47.—Against Volta's theory, 143.—Analysis of Cloze's hydraulic engine, 145.—His account of the appearance of phantoms in the Phantasmagoria, 147
 Woodford, Mr. 60

Y.

Young, Dr. Syllabus of a course of lectures on natural philosophy, 239
 Yvart, 157

Z.

Zach, von, on the planet Ceres, 195.—His letter to Mr. Edward Troughton on the new planet Ceres, 287, 318
 Zoonic acid stated to be merely the acetous, 238

END OF THE FIRST VOLUME.

Herschel's observations on the Sun.

Fig. 1.



Fig. 2.

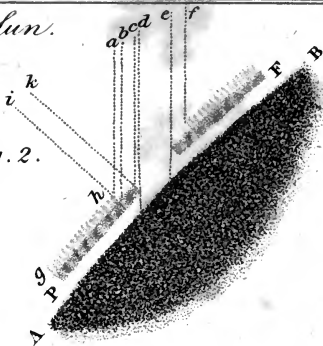

Fig. 4.



Fig. 5.



Fig. 6.



Fig. 3.



Fig. 8.



Fig. 9.



Fig. 7.



Fig. 10.



Fig. 11.

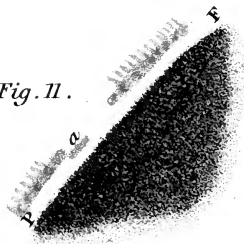

Fig. 12.

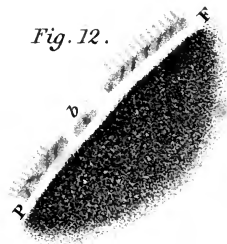

Fig. 13.



Fig. 14.

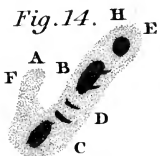

Fig. 15.



Fig. 16.



Fig. 18.



Fig. 17.



Fig. 19.





Fig. 1.

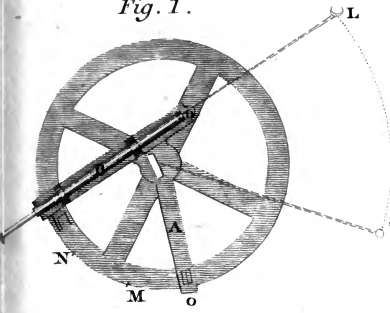
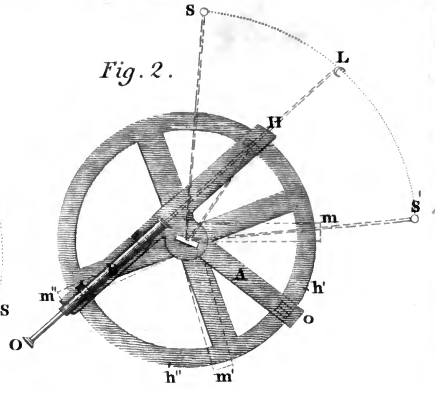
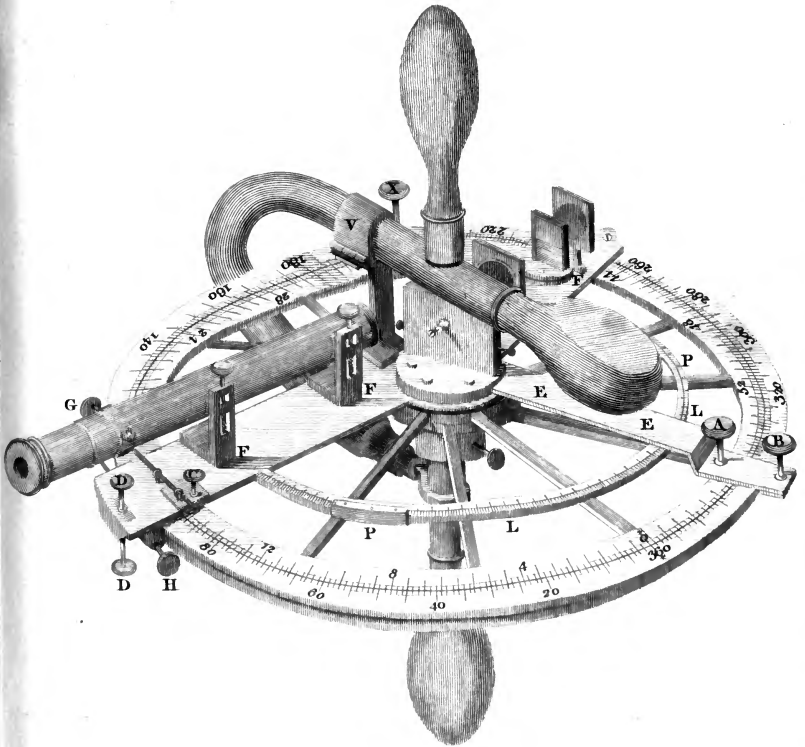

Fig. 2.



Mendoza's New Circular Instrument.





Close's hydraulic apparatus.

Fig. 1.

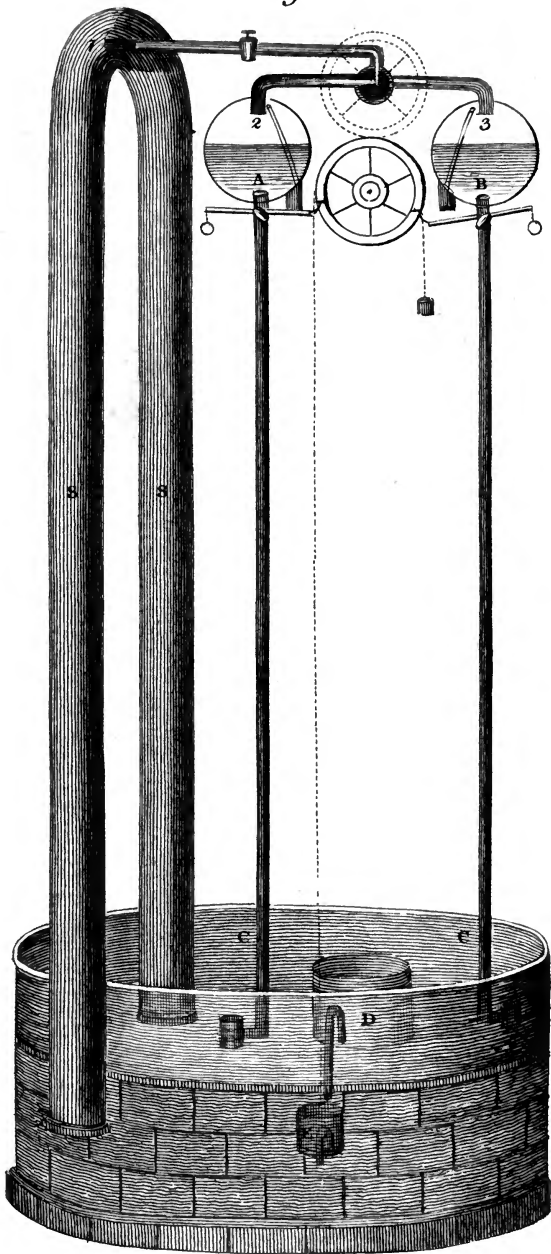



Close's hydraulic apparatus.

Fig. 2.

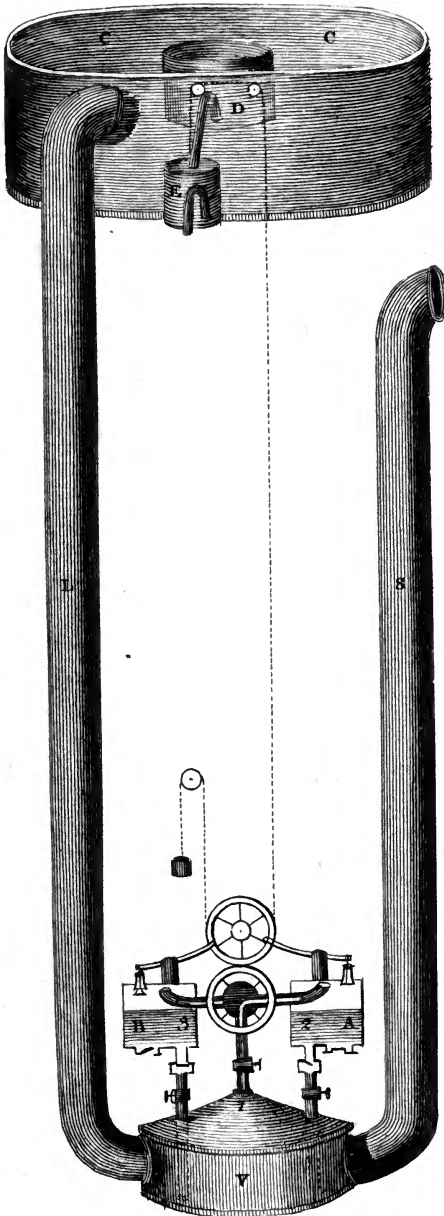



Manufacture of Gun flints.

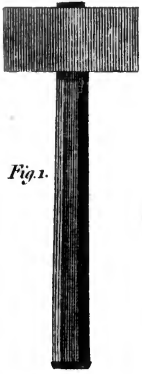

Fig. 1.

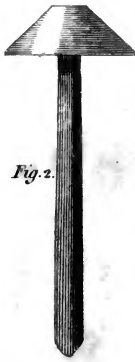

Fig. 2.



Fig. 3.



Fig. 4.

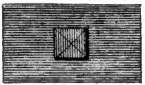

Fig. 5.

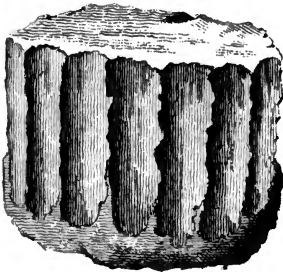

Fig. 6.

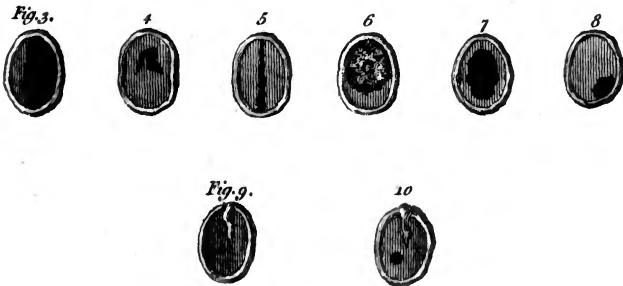
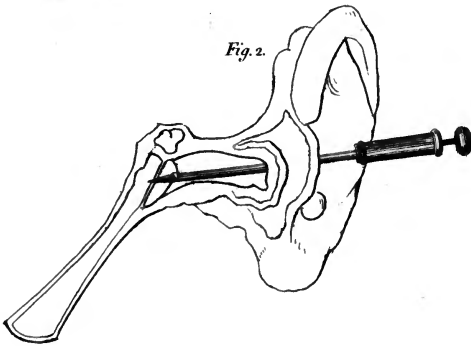
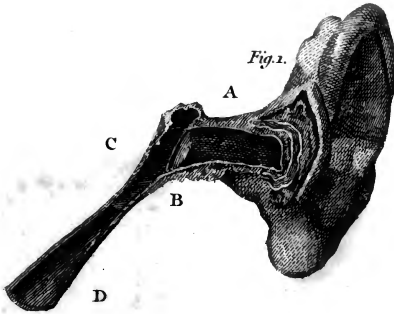

Fig. 7.





Cure of Deafness by puncture of the Membr. tympani.





Bleaching of Paper Stuff.

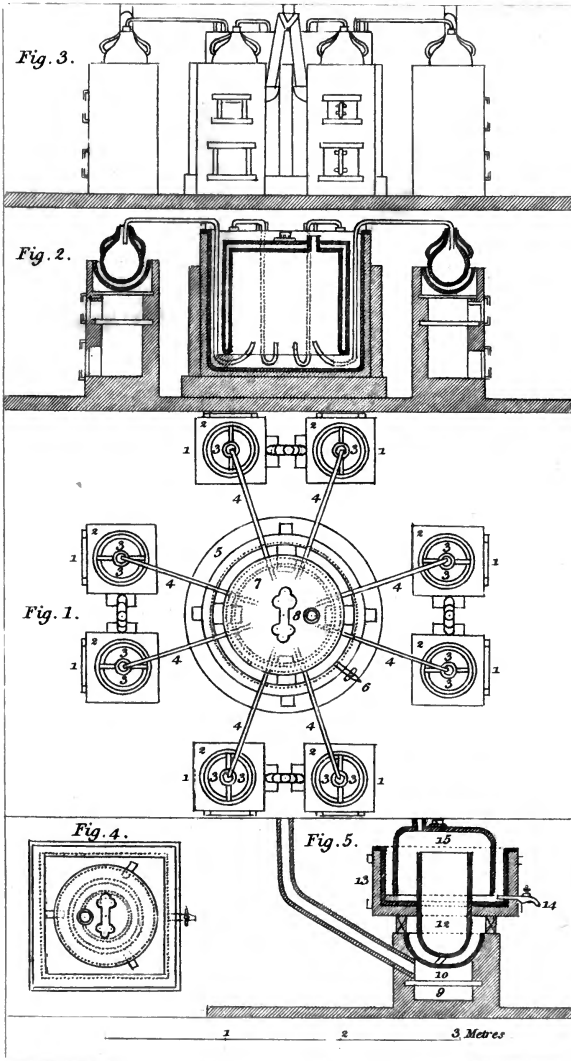



The Graphometer of Carangeau.

Fig. 1.

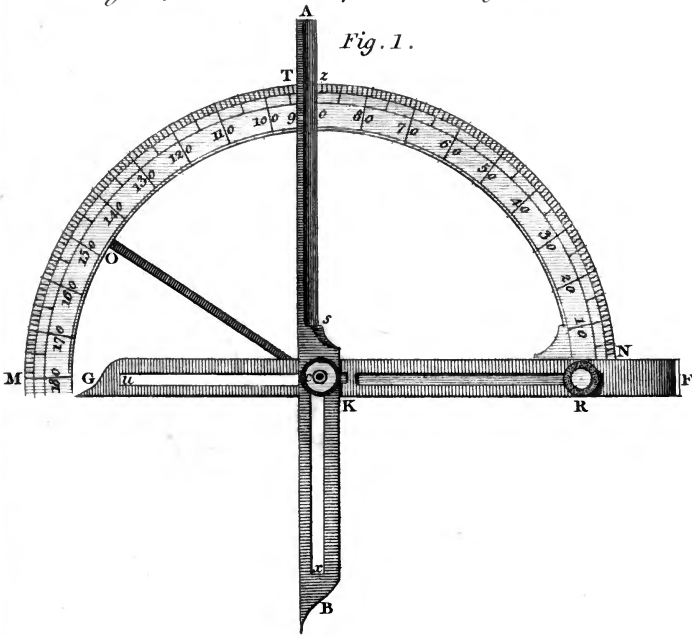

D.^r Thompson's Experiments

To shew that Fluids are not
 thrown into Currents
 by Heat.

Fig. 2.

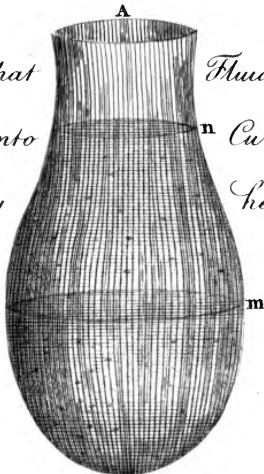

Volta's Theory of Galvanism.

Fig. 3.

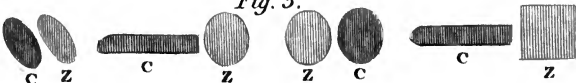



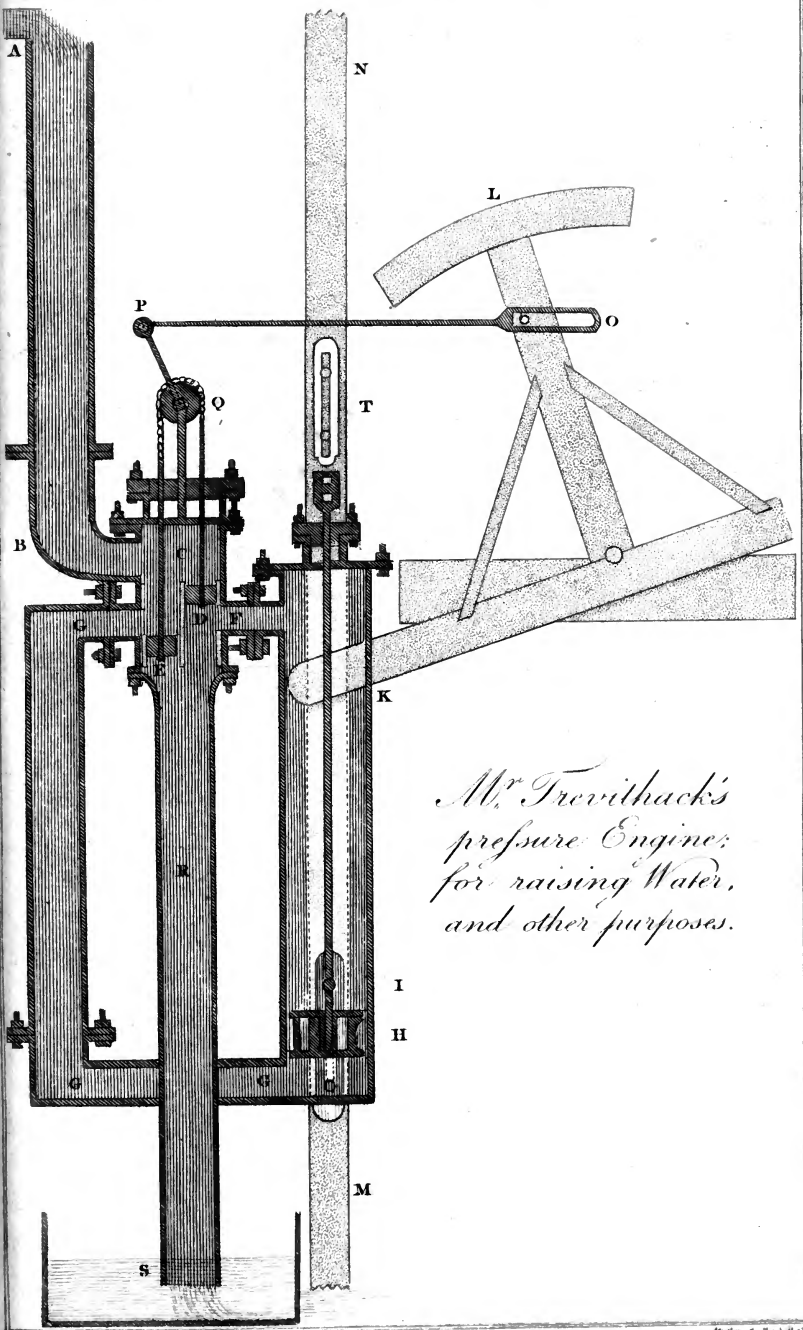

*Mr. Trevithack's
pressure Engine;
for raising Water,
and other purposes.*



Dr Murray's Experiments on heat.

Fig. 1.

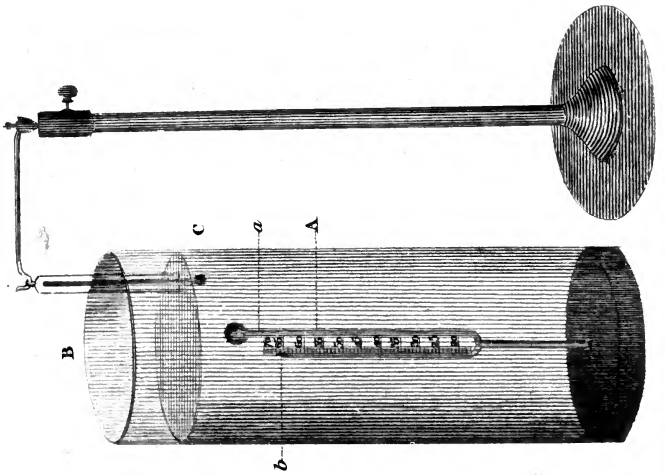
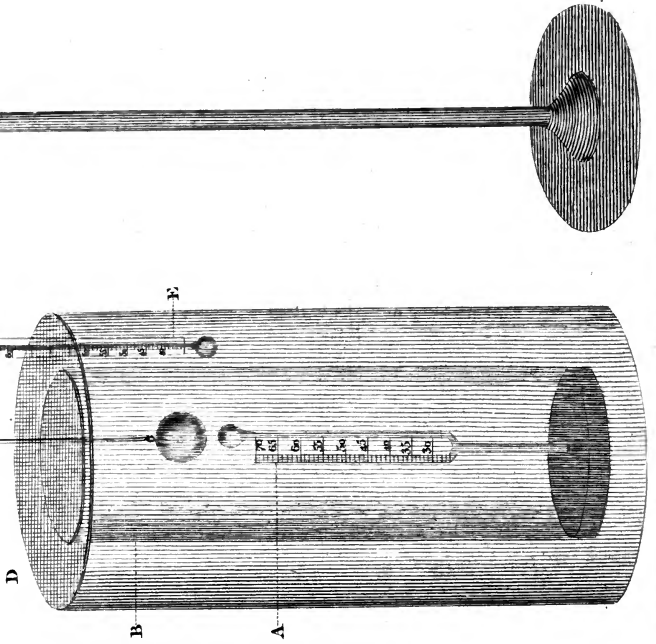

Fig. 2.





Liquids substituted instead of
dark Glasses by Herschel.

Fig. 1.

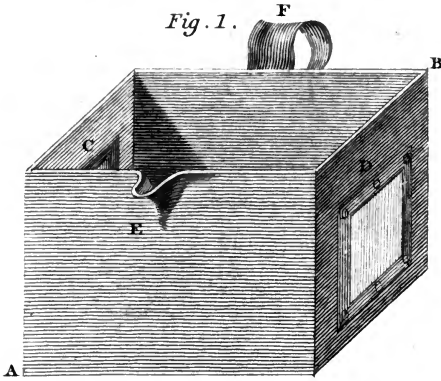

Fig. 2.

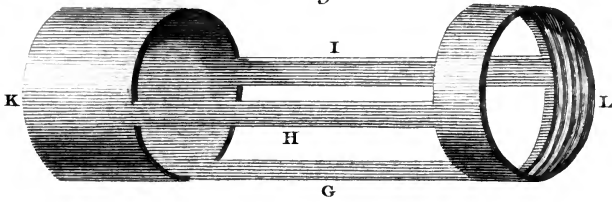
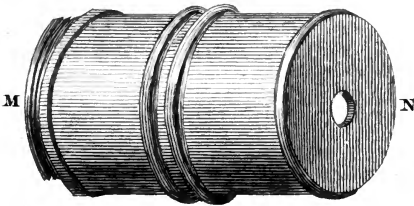
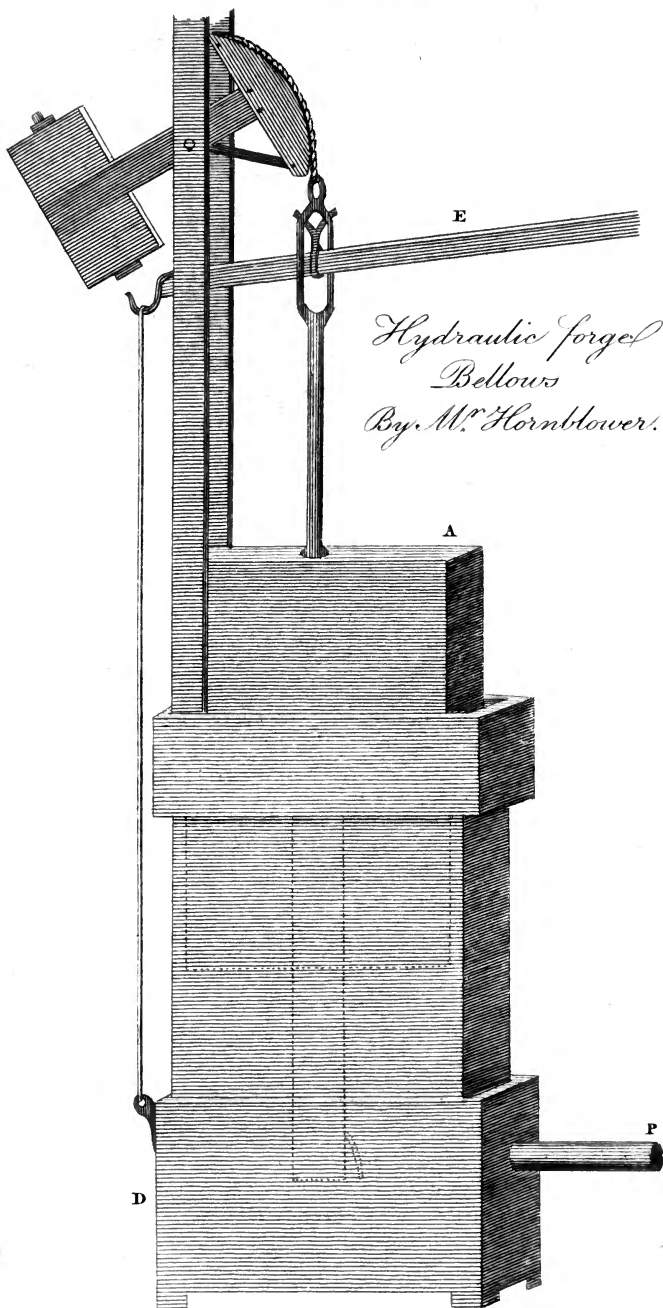

Fig. 3.







*Hydraulic forge
Bellows
By M^r Hornblower.*



Rev. Mr. Pearson's account of the Planet Ceres

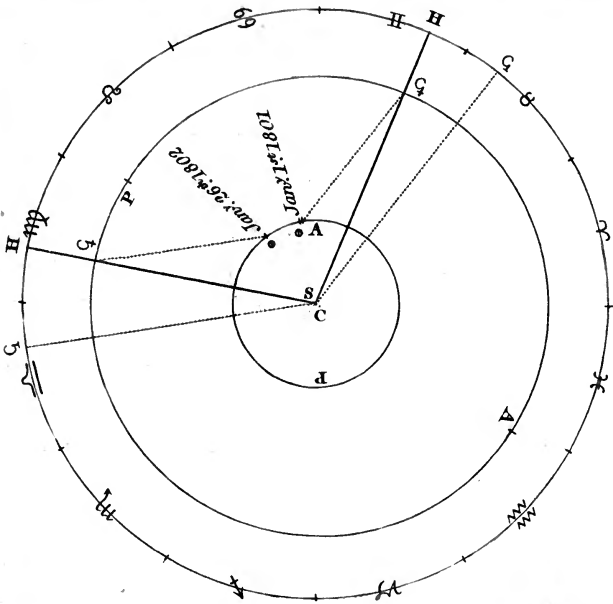

Mr. Murray on the transmission of heat thro' fluids (the vessel Ice)

Fig. 2.

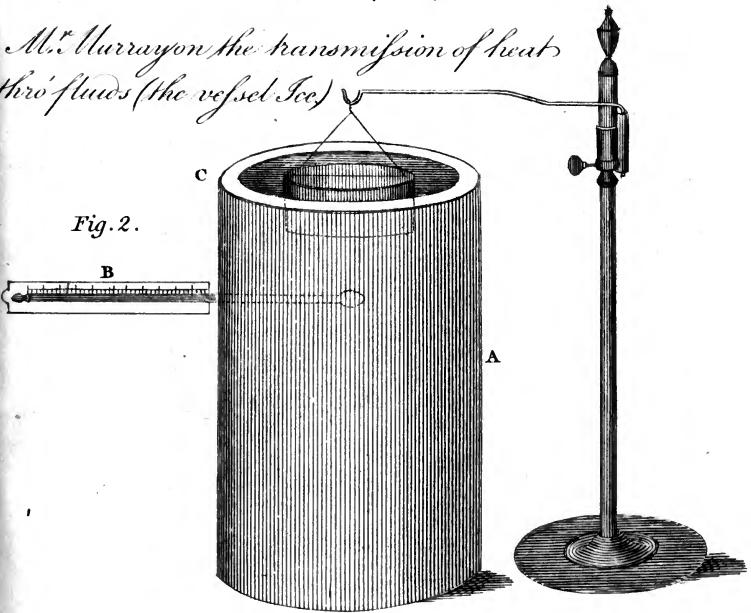



Mr. J. Delafon's Watch Escapements

Fig. 5.

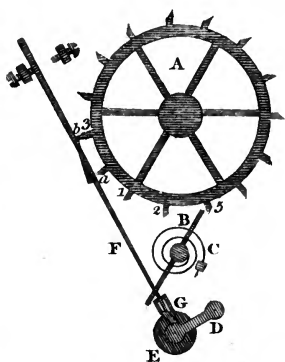

Fig. 3.

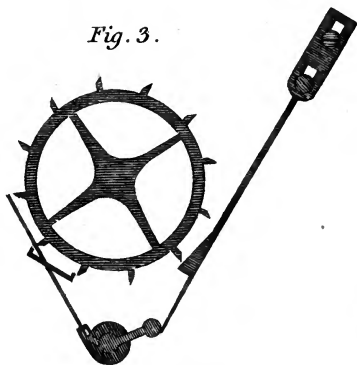

Fig. 1.

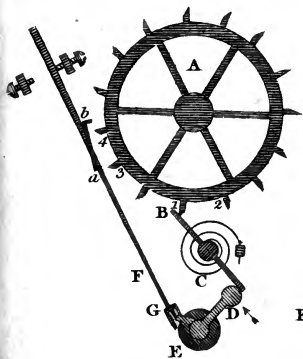

Fig. 2.

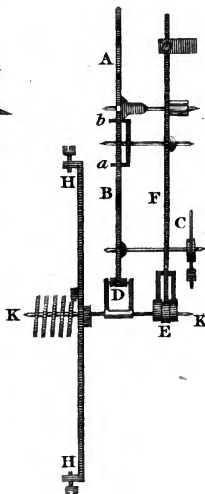
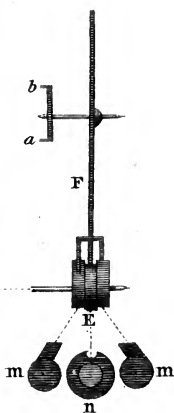

Fig. 4.





Mr. T. Arkwright's Machine for raising Ore from Mines.

Fig. 1.

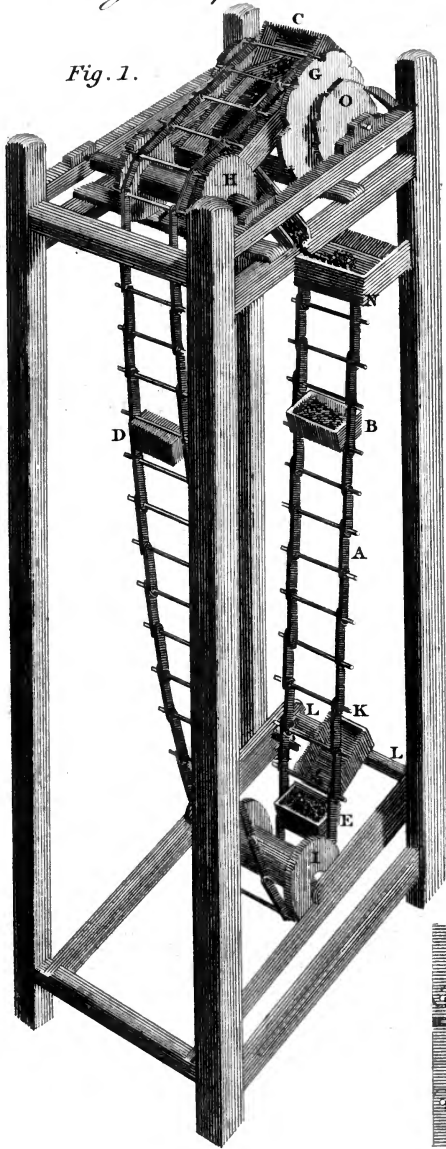
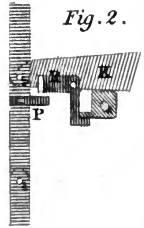

Fig. 2.





*Machine for determining the positions
of objects in drawing from Nature.*

